

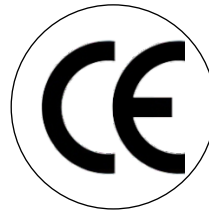

WE SERVE HUMANITY WITH EXCELLENCE

IBRAHIM MEDS



11- BONE SURGERY

Bone Surgery



Amputation Saw
Charrière
IM-11-100-03
Amputation Saw



IM-11-101-22
8 3/4"
12 mm wide

IM-11-102-15
8 3/4"
15 mm wide

IM-11-104-15
8 3/4"
18 mm wide

Spare Saw Blade
Charrière

Bone Surgery



Amputation Saw
Bier
IM-11-110-39
16"



Spare Saw Blade
Bier
IM-11-110-83
10 3/4"
4 mm wide



Spare Saw Blade
Bier
IM-11-110-85
10 3/4"
6 mm wide



Spare Saw Blade
Bier
IM-11-110-87
10 3/4"
8 mm wide

Bone Surgery



Amputation Saw
Langenbeck
IM-11-115-23
9 3/4"



Amputation Saw
Charrière
IM-11-115-27
10 1/2"



Amputation Saw
Satterlee
IM-11-115-31
11 1/2"

Spare Saw Blade
Satterlee
IM-11-115-90
8 1/4"

Bone Surgery



Reamer
IM-11-120-14
5 1/4"



Reamer
Perthes
IM-11-120-18
7"

Bone Surgery

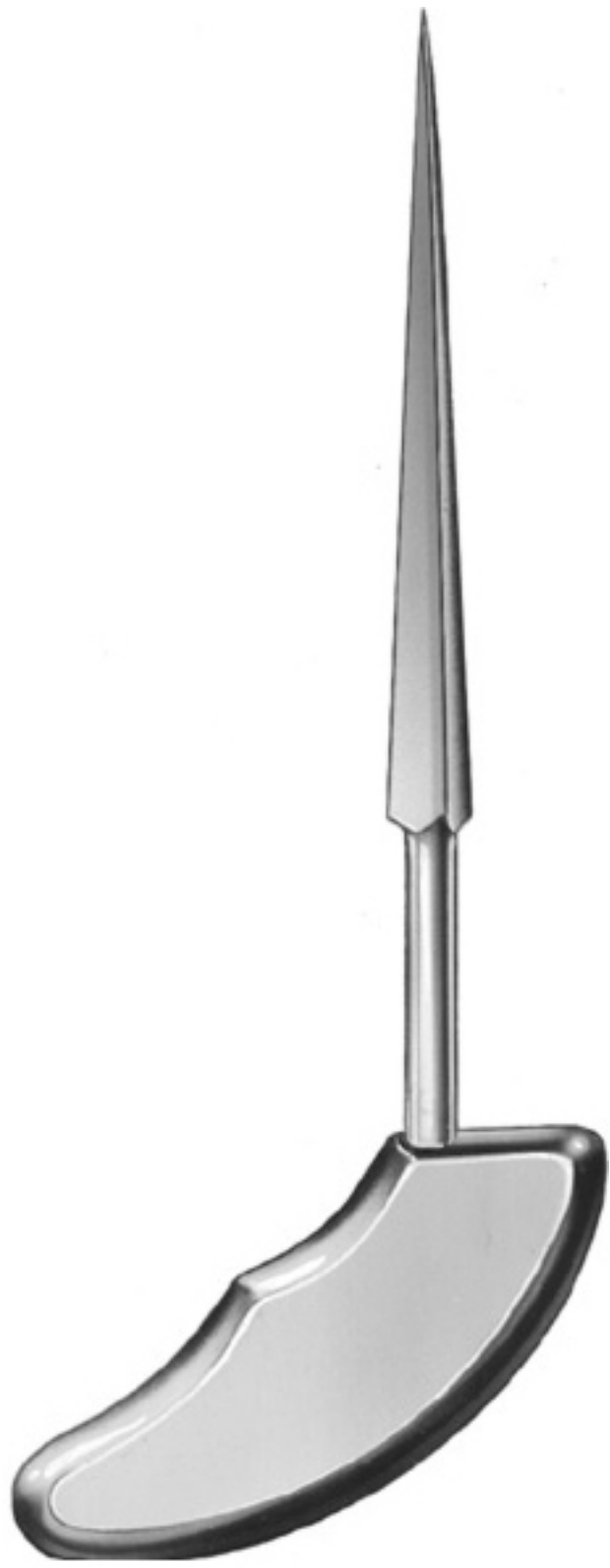

Reamer
Perthes
IM-11-125-21
8 1/2"



Reamer
IM-11-130-14
5 1/2"

Bone Surgery



Hand Drill
Stille-Sherman
IM-11-135-00
9 1/2"



Hand Drill
Stille
IM-11-137-00
8"

Bone Surgery



Twist Drill
IM-11-142-10
Fig. 10 1 mm Ø



Twist Drill
IM-11-142-11
Fig. 11 1,5 mm Ø



Twist Drill
IM-11-142-12
Fig. 1 22 mm Ø



Hand Drill
Hudson
IM-11-140-00
11"

Bone Surgery



Hand Drill
Moore
IM-11-150-00



Twist Drill
IM-11-152-03
set of 3

Bone Surgery



Hand Drill
Martin
IM-11-155-00



Chuck
Jacobs
IM-11-155-06
with Borchardt shaftmax.
opening 6,35 mm



Wrench
IM-11-155-90

Bone Surgery



- IM-11-160-20
Twist Drill
2,0 mm Ø5 mm
Borchardt shaftlong working end
- IM-11-160-25
Twist Drill
2,5 mm Ø5 mm
Borchardt shaftlong working end
- IM-11-160-30
Twist Drill
3,0 mm Ø5 mm
Borchardt shaftlong working end
- IM-11-160-32
Twist Drill
3,2 mm Ø5 mm
Borchardt shaftlong working end
- IM-11-160-35
Twist Drill
3,5 mm Ø5 mm
Borchardt shaftlong working end
- IM-11-160-40
Twist Drill
4,0 mm Ø5 mm
Borchardt shaftlong working end
- IM-11-160-50
Twist Drill
5,0 mm Ø5 mm
Borchardt shaftlong working end
- IM-11-160-60
Twist Drill
6,0 mm Ø5 mm
Borchardt shaftlong working end
- IM-11-160-70
Twist Drill
7,0 mm Ø5 mm
Borchardt shaftlong working end

Bone Surgery



- IM-11-165-10
Twist Drill
1,0 mm Ø5 mm Borchardt shaft
- IM-11-165-12
Twist Drill
1,2 mm Ø5 mm Borchardt shaft
- IM-11-165-15
Twist Drill
1,5 mm Ø5 mm Borchardt shaft
- IM-11-165-18
Twist Drill
1,8 mm Ø5 mm Borchardt shaft
- IM-11-165-20
Twist Drill
2,0 mm Ø5 mm Borchardt shaft
- IM-11-165-22
Twist Drill
2,2 mm Ø5 mm Borchardt shaft
- IM-11-165-25
Twist Drill
2,5 mm Ø5 mm Borchardt shaft
- IM-11-165-28
Twist Drill
2,8 mm Ø5 mm Borchardt shaft
- IM-11-165-30
Twist Drill
3,0 mm Ø5 mm Borchardt shaft
- IM-11-165-32
Twist Drill
3,2 mm Ø5 mm Borchardt shaft
- IM-11-165-35
Twist Drill
3,5 mm Ø5 mm Borchardt shaft
- IM-11-165-40
Twist Drill
4,0 mm Ø5 mm Borchardt shaft
- IM-11-165-50
Twist Drill
5,0 mm Ø5 mm Borchardt shaft

Bone Surgery



- IM-11-199-10
Twist Drill
1,0 mm Øsmooth shaft
- IM-11-199-15
Twist Drill
1,5 mm Øsmooth shaft
- IM-11-199-20
Twist Drill
2,0 mm Øsmooth shaft
- IM-11-199-25
Twist Drill
2,5 mm Øsmooth shaft
- IM-11-199-28
Twist Drill
2,8 mm Øsmooth shaft
- IM-11-199-30
Twist Drill
3,0 mm Øsmooth shaft
- IM-11-199-32
Twist Drill
3,2 mm Øsmooth shaft
- IM-11-199-35
Twist Drill
3,5 mm Øsmooth shaft
- IM-11-199-40
Twist Drill
4,0 mm Øsmooth shaft
- IM-11-199-45
Twist Drill
4,5 mm Øsmooth shaft
- IM-11-199-50
Twist Drill
5,0 mm Øsmooth shaft
- IM-11-199-60
Twist Drill
6,0 mm Øsmooth shaft

Bone Surgery

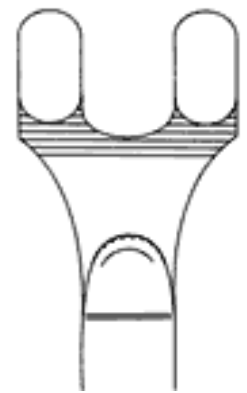

IM-11-200-18
Gerster-Lowman
7"
Bone Holding Clamp

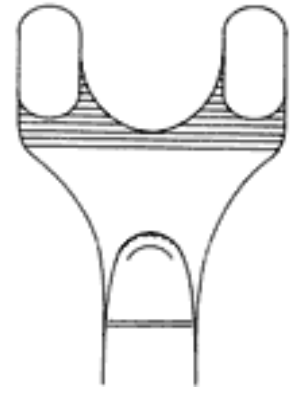

IM-11-200-20
Gerster-Lowman
8"
Bone Holding Clamp

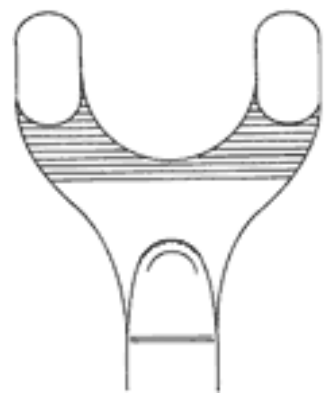

IM-11-200-22
Gerster-Lowman
8 3/4"
Bone Holding Clamp

Bone Surgery



IM-11-210-15
Gerster
Traction Bar

Bone Surgery



IM-11-215-15
6"

IM-11-215-18
7"

Wire Twisting Forceps

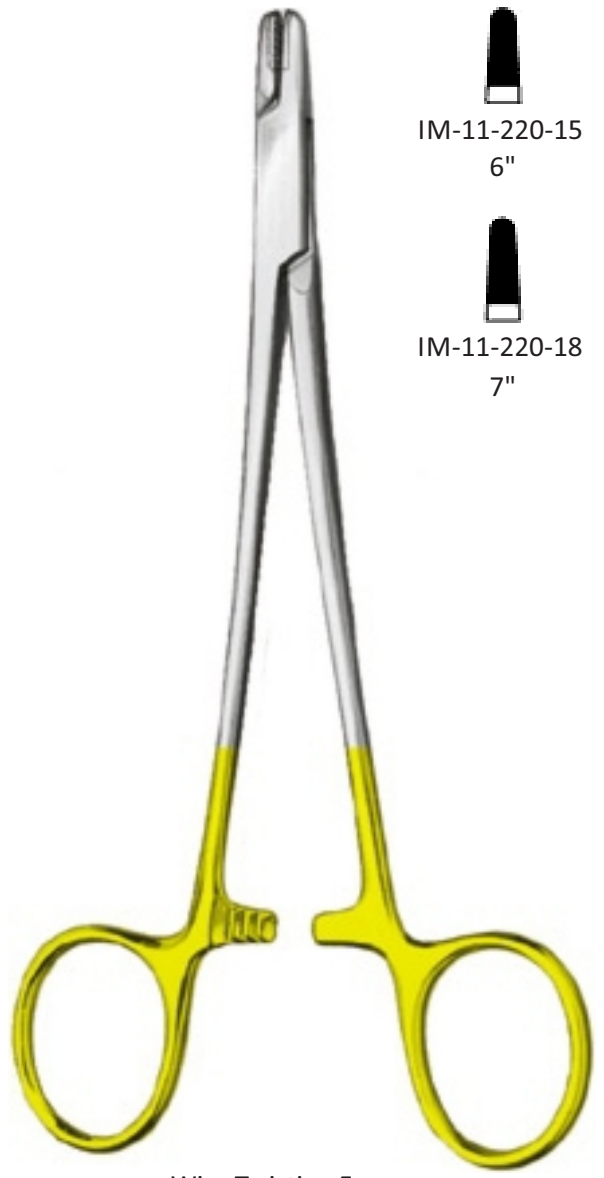

IM-11-220-15
6"

IM-11-220-18
7"

Wire Twisting Forceps

Bone Surgery



IM-11-225-15
6"

IM-11-225-20
8"

Wire Twisting Forceps

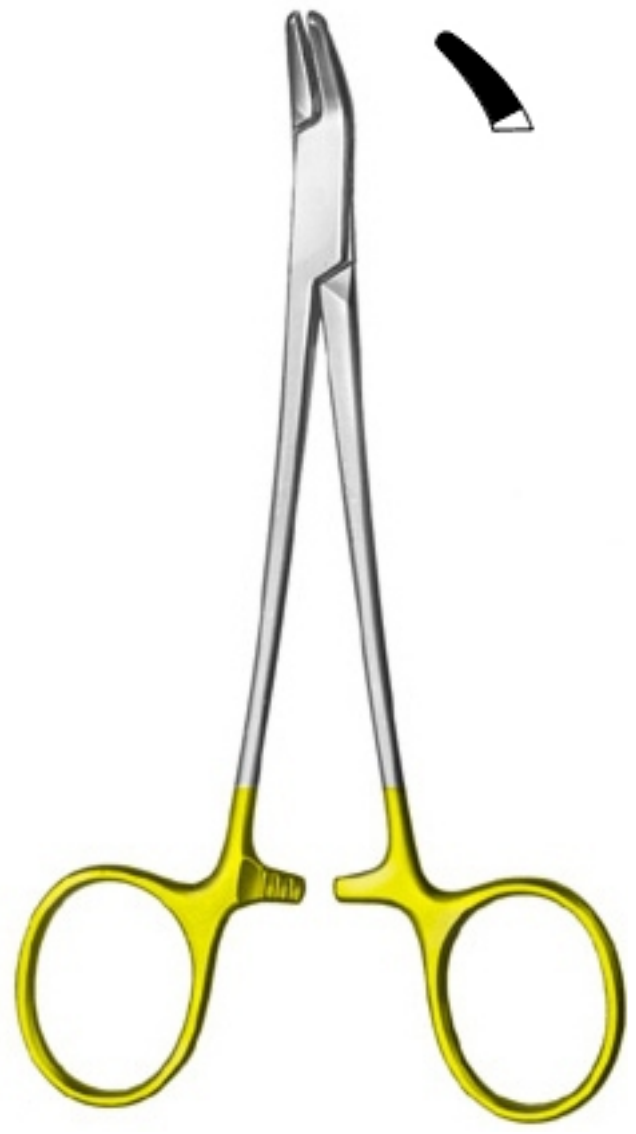

Wire Twisting Forceps
IM-11-230-15
6"

Bone Surgery



IM-11-235-01
Corwin
6 1/4"
Wire Twisting Forceps



IM-11-240-18
Martin
7 1/4"
Combi-Wire Twisting Forceps

Bone Surgery

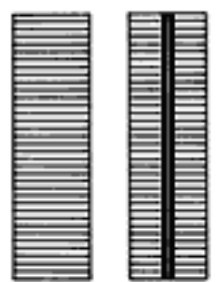

IM-11-245-17
7 1/4"
Flat Nose Plier stainless steel
parallel grip



IM-11-250-17
7 1/4"
Flat Nose Plier stainless steel
parallel grip

Bone Surgery



IM-11-255-20
8"
Vise Grip Stainless Steel



IM-11-260-15
6"
Combi-Flat
Nose Plier
for bending and cutting

Bone Surgery



IM-11-265-18
7"
Flat Nose Plier
parallel grip



Flat Nose Plier
parallel grip

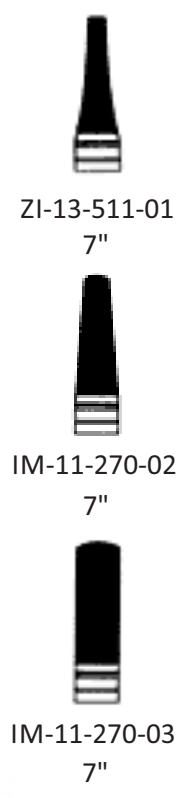

Bone Surgery



IM-11-275-18
7"
Flat Nose Plier
parallel grip



IM-11-277-18
7"
Flat Nose Plier
parallel grip

Bone Surgery



IM-11-280-14
5 1/4"
Flat Nose Plier

IM-11-280-18
7"
Round / Flat Nose Plier

Bone Surgery



IM-11-285-16
Hackstock
6 1/4"
Flat Nose Plier
with longitudinal groove

IM-11-290-01
7"
Flat Nose Plier

Bone Surgery



IM-11-290-02
6 3/4"
Flat Nose Plier
with crosswise groove

IM-11-290-03
7 3/4"
Flat Nose Plier, pointed

Bone Surgery



IM-11-295-18
7 1/4"
Wire Cutting Pliers
for soft wires up to 2,4 mm Ø
for hard wires up to 1,8 mm Ø



IM-11-300-16
Martin "Diamant"
6 1/4"
Wire Cutter, front action
for soft wires up to 2,2 mm Ø
for hard wires up to 2,0 mm Ø
Wire Cutter, front action

Bone Surgery



IM-11-305-01
Martin "Gigant-Compact"
7"
Wire Cutting Pliers
for hard wires up to 2,2 mm Ø



IM-11-305-02
Martin "Gigant-Compact"
9"
Wire Cutting Pliers
for hard wires up to 3,0 mm Ø

Bone Surgery



MI-11-310-16
6 3/4"
Wire Cutting Pliers
for soft wires up to 2,0 mm Ø
for hard wires up to 1,7 mm Ø



MI-11-315-22
8 3/4"
Wire Cutting Pliers
for soft wires up to 2,8 mm Ø
for hard wires up to 2,2 mm Ø

Bone Surgery



MI-11-320-15
6"
Wire Cutting Pliers
for soft wires up to 2,0 mm Ø
for hard wires up to 1,2 mm Ø

MI-11-325-18
7"
Wire Cutting Pliers
for soft wires up to 2,0 mm Ø
for hard wires up to 1,5 mm Ø

Bone Surgery



- MI-11-330-02
Bone Wire
0,2 mm Øsoft, coil of 10 m
- MI-11-330-03
Bone Wire
0,3 mm Øsoft, coil of 10 m
- MI-11-330-04
Bone Wire
0,4 mm Øsoft, coil of 10 m
- MI-11-330-05
Bone Wire
0,5 mm Øsoft, coil of 10 m
- MI-11-330-06
Bone Wire
0,6 mm Øsoft, coil of 10 m
- MI-11-330-07
Bone Wire
0,7 mm Øsoft, coil of 10 m
- MI-11-330-08
Bone Wire
0,8 mm Øsoft, coil of 10 m
- MI-11-330-09
Bone Wire
0,9 mm Øsoft, coil of 10 m
- MI-11-330-10
Bone Wire
1,0 mm Øsoft, coil of 10 m
- MI-11-330-12
Bone Wire
1,2 mm Øsoft, coil of 10 m
- MI-11-330-15
Bone Wire
1,5 mm Øsoft, coil of 10 m



Demel
Wire Guide

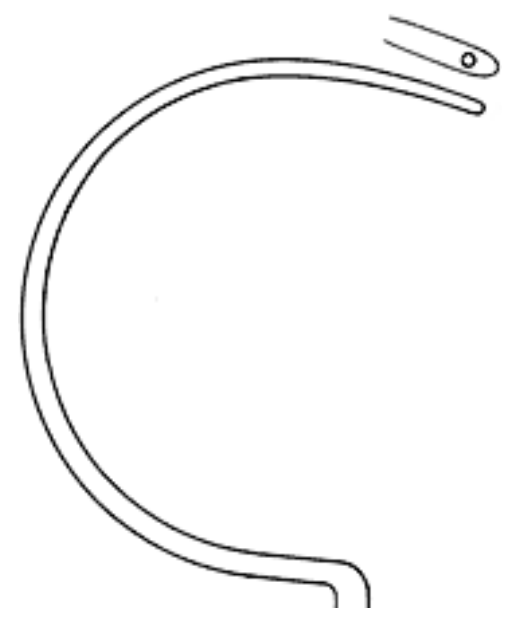

IM-11-332-01
12 1/4"
Fig. 1

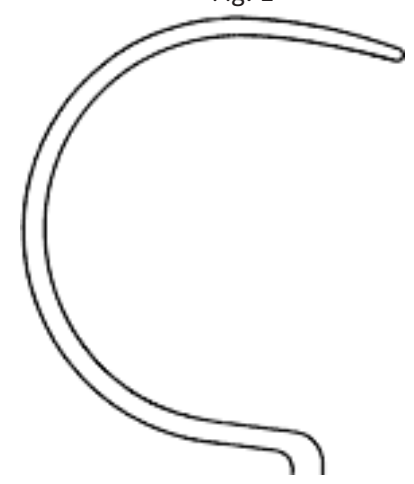

IM-11-332-02
1 1/2"
Fig. 2

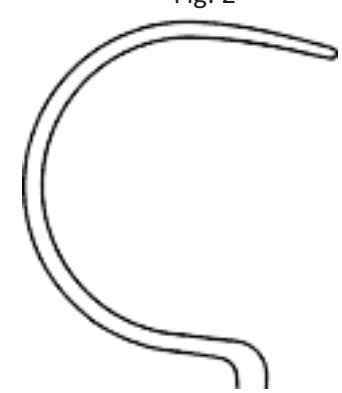

IM-11-332-03
11"
Fig. 3

Bone Surgery



MI-11-335-21
Loute
8 1/4"
Wire Tightener



- IK-11-337-14
Steinmann
5 1/2"
Extension Pin
with trocar point
- IM-11-337-16
Steinmann
6 1/4"
Extension Pin
with trocar point
- IM-11-337-18
Steinmann
7"
Extension Pin
with trocar point
- IM-11-337-20
Steinmann
8"
Extension Pin

Bone Surgery

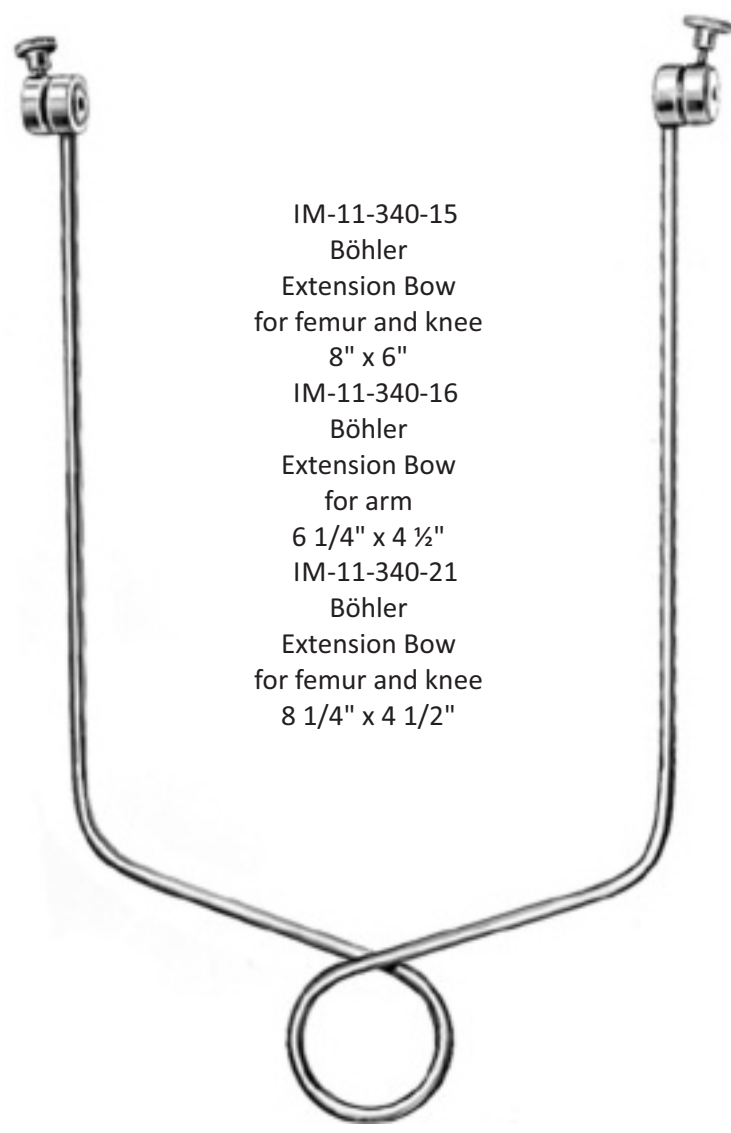

IM-11-340-15
Böhler
Extension Bow
for femur and knee
8" x 6"
IM-11-340-16
Böhler
Extension Bow
for arm
6 1/4" x 4 1/2"
IM-11-340-21
Böhler
Extension Bow
for femur and knee
8 1/4" x 4 1/2"

Bone Surgery

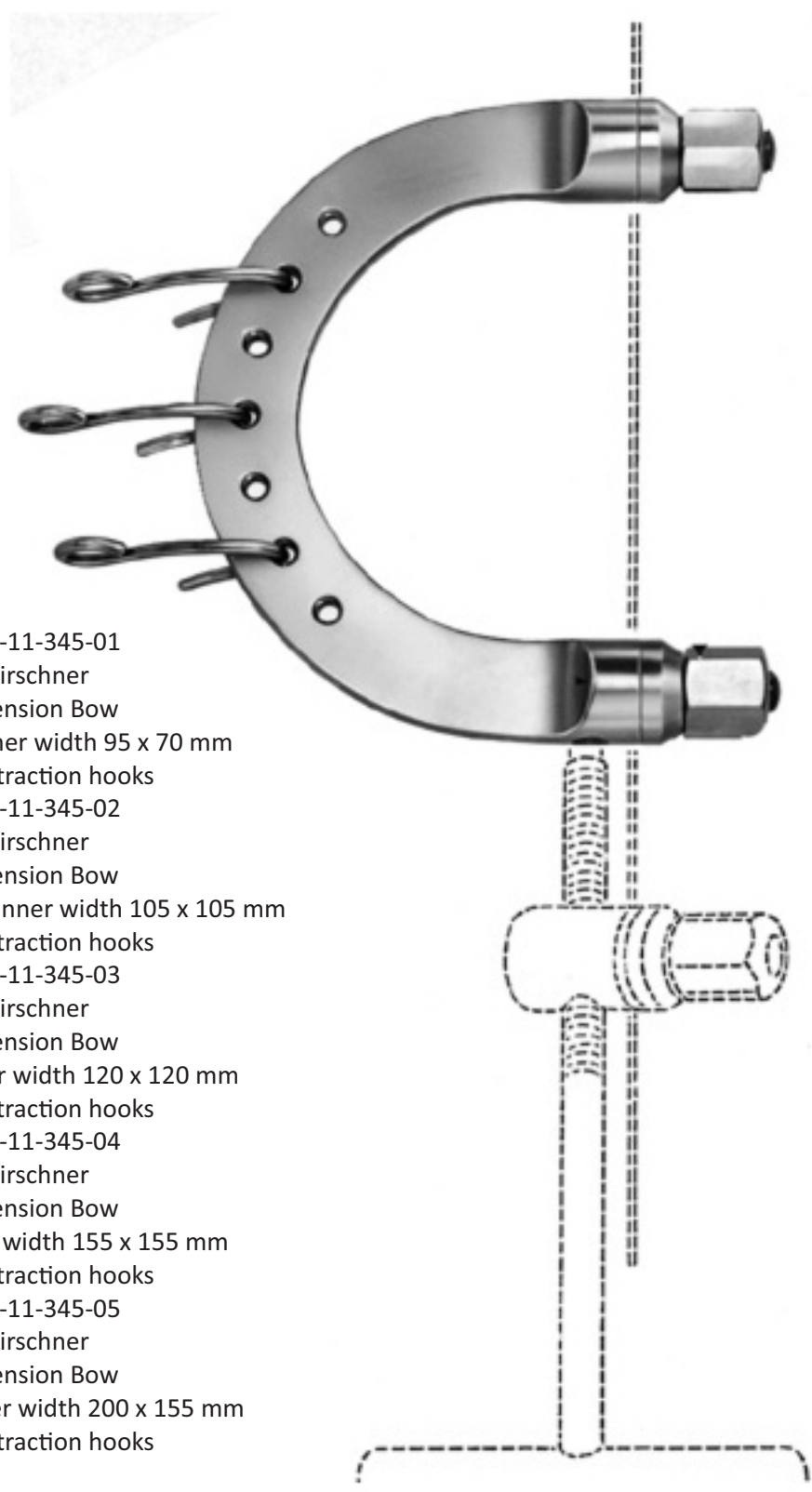

IM-11-345-01
Kirschner
Extension Bow

for children inner width 95 x 70 mm
with 3 traction hooks

IM-11-345-02
Kirschner
Extension Bow

for wrist and ankle inner width 105 x 105 mm
with 3 traction hooks

IM-11-345-03
Kirschner
Extension Bow

for elbow inner width 120 x 120 mm
with 3 traction hooks

IM-11-345-04
Kirschner
Extension Bow

for knee inner width 155 x 155 mm
with 3 traction hooks

IM-11-345-05
Kirschner
Extension Bow

for femur inner width 200 x 155 mm
with 3 traction hooks

Bone Surgery



IM-11-350-01
Kirschner
7 1/4"
Extension Bowsmall pattern
with 3 traction hooks
IM-11-350-02
Kirschner
10 1/2"
Extension Bowlarge pattern
with 3 traction hooks



IM-11-355-18
7 1/4"
Wire Strainer

Bone Surgery



IM-11-360-00

Bunnell

Hand Drill

longitudinally bored with three-jaw-chuck and key
opening up to 4 mm Ølight metal housing

Bone Surgery



IM-11-360-01
Bunnell
Key

Bone Surgery



IM-11-365-01
Ralk
Hand Drill
longitudinally bored
Hand Drill
light metal housing

Bone Surgery



IM-11-370-00
Vickers
5 1/2"
Easidriver

Bone Surgery



IM-11-375-05
Handle with chuck T-shaped
Handles with chuck



IM-10-375-00
Key



IM-10-377-06
Handle with chuck
longitudinally bored
Handles with chuck



IM-10-377-01
Key

Bone Surgery



IM-11-380-00
Virchow
7.53"
Skull Breaker



IM+11-382-02
Buckley
6 1/4"
Chisel
2 mm
octagonal handle



IM-11-382-03
Buckley
6 1/4"
Chisel
3 mm
octagonal handle



IM-11-382-04
Buckley
6 1/4"
Chisel
4 mm
octagonal handle



IM-11-384-02
Buckley
6 1/4"
Gouge
2 mm
octagonal handle



IM-11-384-03
Buckley
6 1/4"
Gouge
3 mm
octagonal handle



PM-11-384-04
Buckley
6 1/4"
Gouge
4 mm
octagonal handle

Bone Surgery



IM-11-385-03
Stout
8 1/4"
Bone Chisel
3 mm
octagonal handle



IM-11-385-04
Stout
8 1/4"
Bone Chisel
4 mm
octagonal handle



IM-11-385-05
Stout
8 1/4"
Bone Chisel
5 mm
octagonal handle

Bone Surgery



IM-11-390-04
7"
Bone Chisel
4 mm
octagonal handle

IM-11-390-04
7"
Bone Chisel
4 mm
octagonal handle

Bone Surgery



IM-11-395-04
6 3/4"
Bone Chisel
4 mm



IM-11-397-04
6 3/4"
Bone Chisel
4 mm

Bone Surgery

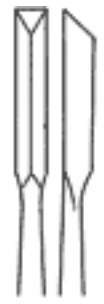

IM-11-400-01
Gardner
6 3/4"
Bone Chisel
4 mm
triangular shape

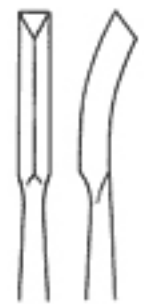

IM-11-400-02
Gardner
6 3/4"
Bone Chisel
4 mm
triangular shape

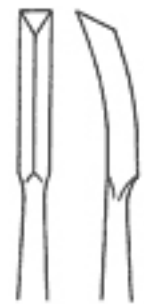

IM-11-400-03
Gardner
6 3/4"
Bone Chisel
4 mm
triangular shape

Bone Surgery



IM-11-405-03
Snyder-O.S.U
6 1/2"
Bone Chise
13 mm



IM-11-405-05
Snyder-O.S.U
6 1/2"
Bone Chisel
5 mm

Bone Surgery













IM-11-410-01
O.S.U.
6 3/4"
Bone Chisel
7 mm

IM-11-412-01
O.S.U.
6 3/4"
Bone Chisel
9 mm

Bone Surgery







				
IM-11-415-08 5 1/4" Osteotome 8 mm	IM-11-415-10 5 1/4" Osteotome 10 mm	IM-11-415-12 5 1/4" Osteotome 12 mm	IM-11-415-14 5 1/4" Osteotome 14 mm	IM-11-415-16 5 1/4" Osteotome 16 mm





				
IM-11-417-08 5 1/4" Chisel 8 mm	IM-11-417-10 5 1/4" Chisel 10 mm	IM-11-417-12 5 1/4" Chisel 12 mm	IM-11-417-14 5 1/4" Chisel 14 mm	IM-10-417-16 5 1/4" Chisel 16 mm







Bone Surgery



				
IM-11-420-08	IM-11-420-10	IM-11-420-12	IM-11-420-14	IM-11-420-16
5 1/4"	5 1/4"	5 1/4"	5 1/4"	5 1/4"
Gouge	Gouge	Gouge	Gouge	Gouge
8 mm	10 mm	12 mm	14 mm	16 mm

				
IM-11-422-02	IM-11-422-03	IM-11-422-04	IM-11-422-05	IM-11-422-06
Partsch	Partsch	Partsch	Partsch	Partsch
13.5cm 5 1/4"	13.5cm 5 1/4"	13.5cm 5 1/4"	13.5cm 5 1/4"	13.5cm 5 1/4"
Chisel	Chisel	Chisel	Chisel	Chisel
2 mm	3 mm	4 mm	5 mm	6 mm

				
IM-11-424-02	IM-11-424-03	IM-11-424-04	IM-11-424-05	IM-11-424-06
Partsch	Partsch	Partsch	Partsch	Partsch
17cm 5 1/4"	17cm 5 1/4"	17cm 5 1/4"	17cm 5 1/4"	17cm 5 1/4"
Chisel	Chisel	Chisel	Chisel	Chisel
2 mm	3 mm	4 mm	5 mm	6 mm



Bone Surgery



IM-11-425-02
Partsch
13.5cm 5 1/4"
Gouge
2 mm



IM-11-425-03
Partsch
13.5cm 5 1/4"
Gouge
3 mm



IM-11-425-04
Partsch
13.5cm 5 1/4"
Gouge
4 mm



IM-11-425-05
Partsch
13.5cm 5 1/4"
Gouge
5 mm



IM-11-425-06
Partsch
13.5cm 5 1/4"
Gouge
6 mm



IM-11-427-02
Partsch
17cm 5 1/4"
Gouge
2 mm



IM-11-427-03
Partsch
17cm 5 1/4"
Gouge
3 mm



IM-11-427-04
Partsch
17cm 5 1/4"
Gouge
4 mm



IM-11-427-05
Partsch
17cm 5 1/4"
Gouge
5 mm



IM-11-427-06
Partsch
17cm 5 1/4"
Gouge
6 mm

Bone Surgery



IM-11-430-04
Alexander
17.5cm 7"
Chisel
4 mm solid



IM-11-430-06
Alexander
17.5cm 7"
Chisel
6 mm solid



IM-11-430-08
Alexander
17.5cm 7"
Chisel
8 mm solid



IM-11-430-10
Alexander
17.5cm 7"
Chisel
10 mm solid

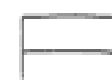







IM-11-430-12
Alexander
17.5cm 7"
Chisel
12 mm solid



IM-11-430-14
Alexander
17.5cm 7"
Chisel
14 mm solid

Bone Surgery



					
IM-11-435-04	IM-11-435-06	IM-11-435-08	IM-11-435-10	IM-11-435-12	IM-11-435-14
Alexander	Alexander	Alexander	Alexander	Alexander	Alexander
17.5cm 7"	17.5cm 7"	17.5cm 7"	17.5cm 7"	17.5cm 7"	17.5cm 7"
Gouge	Gouge	Gouge	Gouge	Gouge	Gouge
4 mm	6 mm	8 mm	10 mm	12 mm	14 mm

Bone Surgery



IM-11-440-10
Stille
20cm 8"
Chisel
10 mm

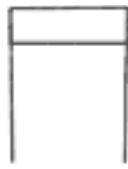

IM-11-440-15
Stille
20cm 8"
Chisel
15 mm

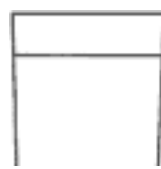





IM-11-440-20
Stille
20cm 8"
Chisel
20 mm



IM-11-440-25
Stille
20cm 8"
Chisel
25 mm

Bone Surgery



			
<p>IM-11-445-10 Stille 20cm 8" Osteotome 10 mm</p>	<p>IM-11-445-15 Stille 20cm 8" Osteotome 15 mm</p>	<p>IM-11-445-20 Stille 20cm 8" Osteotome 20 mm</p>	<p>IM-11-445-25 Stille 20cm 8" Osteotome 25 mm</p>

Bone Surgery



IM-11-450-10
Stille
20cm 8"
Gouge
10 mm



IM-11-450-15
Stille
20cm 8"
Gouge
15 mm



IM-11-450-20
Stille
20cm 8"
Gouge
20 mm



IM-11-450-25
Stille
20cm 8"
Gouge
25 mm

Bone Surgery

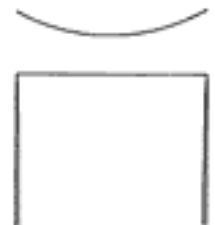

IM-11-455-50
13.5cm 5 1/4"
Gouge Blade
25 mmr = 50 mm
Gouge blades,
interchangeable

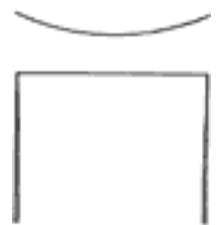

IM-11-455-60
13.5cm 5 1/4"
Gouge Blade
25 mmr = 60 mm
Gouge blades, -
interchangeable

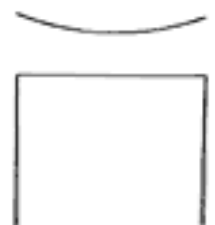

IM-11-455-70
13.5cm 5 1/4"
Gouge Blade
25 mmr = 70 mm
Gouge blades,
interchangeable



IM-11-460-00
18.5cm 7 1/4"
Chisel Handle
Handle, only



IM-11-460-05
8.5cm 3 1/4"
Chisel Blade
5 mm
Chisel blades,
interchangeable



IM-11-460-10
8.5cm 3 1/4"
Chisel Blade
10 mm
Chisel blades,
interchangeable



IM-11-460-16
8.5cm 3 1/4"
Chisel Blade
16 mm
Chisel blades,
interchangeable



IM-11-460-25
8.5cm 3 1/4"
Chisel Blade
25 mm
Chisel blades,
interchangeable



Bone Surgery



IM-11-465-00
Spare Screw



IM-11-465-55
8.5cm 3 1/4"
Osteotome Blade
5 mm
Osteotome blades
interchangeable



IM-11-465-60
8.5cm 3 1/4"
Osteotome Blade
10 mm
Osteotome blades
interchangeable



IM-11-465-66
8.5cm 3 1/4"
Osteotome Blade
16 mm
Osteotome blades
interchangeable



IM-11-465-85
8.5cm 3 1/4"
Osteotome Blade
25 mm
Osteotome blades
interchangeable

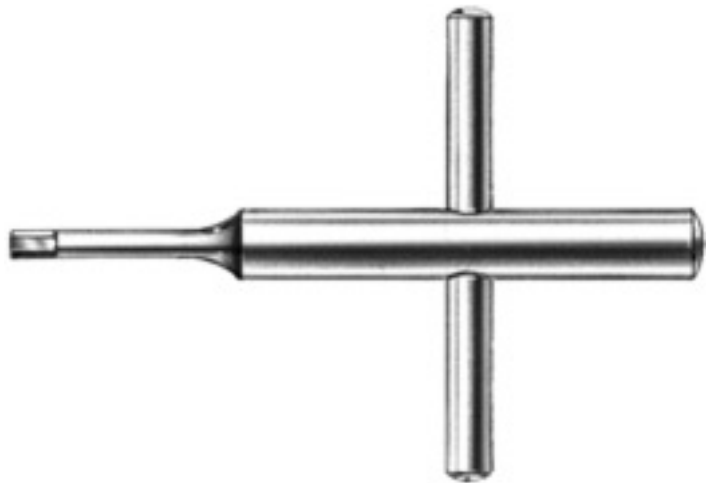

IM-11-470-99
9cm 3 1/2"
Key

Bone Surgery

IM-11-480-05
Lexer
25cm 9 3/4"
Spongiosa Gouge
5 mm



IM-11-480-10
Lexer
25cm 9 3/4"
Spongiosa Gouge
10 mm



IM-11-480-15
Lexer
25cm 9 3/4"
Spongiosa Gouge
15 mm



IM-11-480-55
Lexer
25cm 9 3/4"
Spongiosa Gouge
5 mm



IM-11-480-60
Lexer
25cm 9 3/4"
Spongiosa Gouge
10 mm



IM-11-480-65
Lexer
25cm 9 3/4"
Spongiosa Gouge
15 mm



Bone Surgery



IM-11-485-04
Lexer, Mini
18.5cm 7 1/4"
Osteotome
4 mm



IM-11-485-06
Lexer, Mini
18.5cm 7 1/4"
Osteotome
6 mm



IM-11-485-08
Lexer, Mini
18.5cm 7 1/4"
Osteotome
8 mm



IM-11-485-10
Lexer, Mini
18.5cm 7 1/4"
Osteotome
10 mm



IM-11-485-12
Lexer, Mini
18.5cm 7 1/4"
Osteotome
12 mm

Bone Surgery



IM-11-490-04	IM-11-490-06	IM-11-490-08	IM-11-490-10	IM-11-490-12
Lexer, Mini	Lexer, Mini	Lexer, Mini	Lexer, Mini	Lexer, Mini
18.5cm 7 1/4"	18.5cm 7 1/4"	18.5cm 7 1/4"	18.5cm 7 1/4"	18.5cm 7 1/4"
Gouge	Gouge	Gouge	Gouge	Gouge
4 mm	6 mm	8 mm	10 mm	12 mm

Bone Surgery



IM-11-495-07
Lexer
22cm 8 3/4"
Osteotome
7 mm



IM-11-495-10
Lexer
22cm 8 3/4"
Osteotome
10 mm



IM-11-495-15
Lexer
22cm 8 3/4"
Osteotome
15 mm



IM-11-495-20
Lexer
22cm 8 3/4"
Osteotome
20 mm



IM-11-495-25
Lexer
22cm 8 3/4"
Osteotome
25 mm



IM-11-495-30
Lexer
22cm 8 3/4"
Osteotome
30 mm

Bone Surgery



IM11-500-07
Lexer
22cm 8 3/4"
Gouge
7 mm

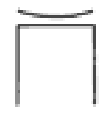

IM-11-500-10
Lexer
22cm 8 3/4"
Gouge
10 mm



IM-11-500-15
Lexer
22cm 8 3/4"
Gouge
15mm

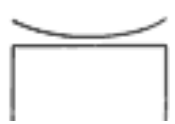

IM-11-500-20
Lexer
22cm 8 3/4"
Gouge
20 mm

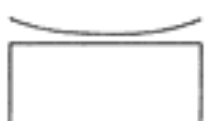

IM-11-500-25
Lexer
22cm 8 3/4"
Gouge
25 mm



IM-11-500-30
Lexer
22cm 8 3/4"
Gouge
30mm



IM-11-505-02
Lambotte, Mini
12.5cm 5"
Osteotome
2 mm



IM-11-505-03
Lambotte, Mini
12.5cm 5"
Osteotome
3 mm



IM-11-505-04
Lambotte, Mini
12.5cm 5"
Osteotome
4 mm



IM-11-505-06
Lambotte, Mini
12.5cm 5"
Osteotome
6 mm



IM-11-505-08
Lambotte, Mini
12.5cm 5"
Osteotome
8mm



IM-11-505-10
Lambotte, Mini
12.5cm 5"
Osteotome
10 mm

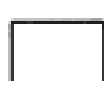

IM-11-505-12
Lambotte, Mini
12.5cm 5"
Osteotome
12 mm

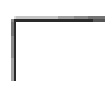

IM-11-505-15
Lambotte, Mini
17cm 5"
Osteotome
15 mm



Bone Surgery



IM-11-510-53
Lambotte, Mini
17cm 6 3/4"
Osteotome
3 mm



IM-11-510-54
Lambotte, Mini
17cm 6 3/4"
Osteotome
4 mm



IM-11-510-56
Lambotte, Mini
17cm 6 3/4"
Osteotome
6 mm



IM-11-510-58
Lambotte, Mini
17cm 6 3/4"
Osteotome
8 mm



IM-11-510-60
Lambotte, Mini
17cm 6 3/4"
Osteotome
10 mm



IM-11-510-62
Lambotte, Mini
17cm 6 3/4"
Osteotome
12 mm



IM-11-510-65
Lambotte, Mini
17cm 6 3/4"
Osteotome
15 mm

Bone Surgery

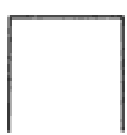

IM-11-515-15
Lambotte
24cm 9 ½"
Osteotome
15 mm



IM-11-515-20
Lambotte
24cm 9 ½"
Osteotome
20 mm



IM-11-515-25
Lambotte
24cm 9 ½"
Osteotome
25 mm



IM-11-515-30
Lambotte
24cm 9 ½"
Osteotome
30 mm



IM-11-515-38
Lambotte
24cm 9 ½"
Osteotome
38 mm



IM-11-515-44
Lambotte
24cm 9 ½"
Osteotome
44 mm



IM-11-515-50
Lambotte
24cm 9 ½"
Osteotome
50 mm

Bone Surgery

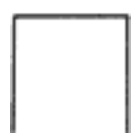

IM-11-520-15
Lambotte
24cm 9 ½"
Osteotome
15 mm



IM-11-520-20
Lambotte
24cm 9 ½"
Osteotome
20 mm

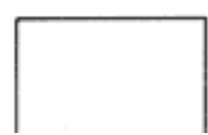

IM-11-520-25
Lambotte
24cm 9 ½"
Osteotome
25 mm



IM-11-520-30
Lambotte
24cm 9 ½"
Osteotome
30 mm

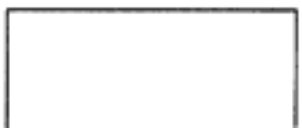

IM-11-520-38
Lambotte
24cm 9 ½"
Osteotome
38 mm

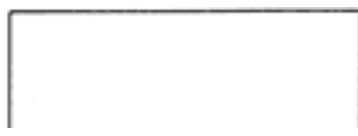

IM-11-520-44
Lambotte
24cm 9 ½"
Osteotome
44 mm

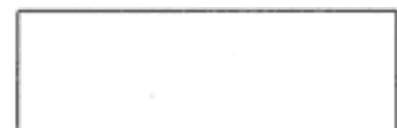

IM-11-520-50
Lambotte
24cm 9 ½"
Osteotome
50 mm

Bone Surgery



IM-11-525-06
Smith-Petersen
20.5cm 8"
Osteotome
6 mm



IM-11-525-09
Smith-Petersen
20.5cm 8"
Osteotome
9 mm



IM-11-525-13
Smith-Petersen
20.5cm 8"
Osteotome
13 mm



IM-11-525-16
Smith-Petersen
20.5cm 8"
Osteotome
16 mm



IM-11-525-19
Smith-Petersen
20.5cm 8"
Osteotome
19 mm



IM-11-525-25
Smith-Petersen
20.5cm 8"
Osteotome
25 mm

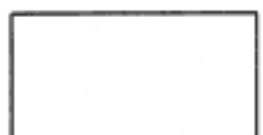

IM-11-525-32
Smith-Petersen
20.5cm 8"
Osteotome
32 mm

Bone Surgery



IM-11-530-06
Smith-Petersen
20.5cm 8"
Osteotome
6 mm



IM-11-530-09
Smith-Petersen
20.5cm 8"
Osteotome
9 mm



IM-11-530-13
Smith-Petersen
20.5cm 8"
Osteotome
13 mm



IM-11-530-16
Smith-Petersen
20.5cm 8"
Osteotome
16 mm

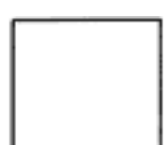

IM-11-530-19
Smith-Petersen
20.5cm 8"
Osteotome
19 mm



IM-11-530-25
Smith-Petersen
20.5cm 8"
Osteotome
25 mm



IM-11-530-32
Smith-Petersen
20.5cm 8"
Osteotome
32 mm

Bone Surgery



IM-11-535-09
Smith-Petersen
20.5cm 8"
Gouge
9 mm



IM-11-535-14
Smith-Petersen
20.5cm 8"
Gouge
14 mm



IM-11-535-19
Smith-Petersen
20.5cm 8"
Gouge
19 mm

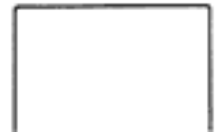

IM-11-535-25
Smith-Petersen
20.5cm 8"
Gouge
25 mm

Bone Surgery



IM-11-540-09
Smith-Petersen
20.5cm 8"
Gouge
9 mm



IM-11-540-14
Smith-Petersen
20.5cm 8"
Gouge
14 mm





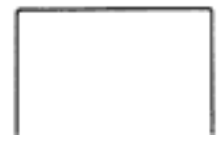

IM-11-540-19
Smith-Petersen
20.5cm 8"
Gouge
19 mm



IM-11-540-25
Smith-Petersen
20.5cm 8"
Gouge
25 mm





Bone Surgery





				
IM-11-545-03	IM-11-545-05	IM-11-545-06	IM-11-545-08	IM-11-545-09
Hoke	Hoke	Hoke	Hoke	Hoke
17cm 6 3/4"	17cm 6 3/4"	17cm 6 3/4"	17cm 6 3/4"	17cm 6 3/4"
Osteotome	Osteotome	Osteotome	Osteotome	Osteotome
3 mm	5 mm	6 mm	8 mm	9 mm



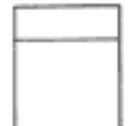

Bone Surgery

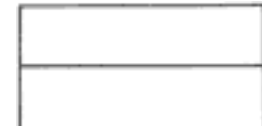

				
IM-11-550-06 Hibbs 24.5cm 9 3/4" Osteotome 6 mm	IM-11-550-13 Hibbs 24.5cm 9 3/4" Osteotome 13 mm	IM-11-550-19 Hibbs 24.5cm 9 3/4" Osteotome 19 mm	IM-11-550-25 Hibbs 24.5cm 9 3/4" Osteotome 25 mm	IM-11-550-32 Hibbs 24.5cm 9 3/4" Osteotome 32 mm

				
IM-11-552-06 Hibbs 24.5cm 9 3/4" Chisel 6 mm	IM-11-552-13 Hibbs 24.5cm 9 3/4" Chisel 13 mm	IM-11-552-19 Hibbs 24.5cm 9 3/4" Chisel 19 mm	IM-11-552-25 Hibbs 24.5cm 9 3/4" Chisel 25 mm	IM-11-552-32 Hibbs 24.5cm 9 3/4" Chisel 32 mm



				
IM-11-555-06 Hibbs 24.5cm 9 3/4" Osteotome 6 mm	IM-11-555-13 Hibbs 24.5cm 9 3/4" Osteotome 13 mm	IM-11-555-19 Hibbs 24.5cm 9 3/4" Osteotome 19 mm	IM-11-555-25 Hibbs 24.5cm 9 3/4" Osteotome 25 mm	IM-11-555-32 Hibbs 24.5cm 9 3/4" Osteotome 32 mm

Bone Surgery



IM-11-560-06	IM-11-560-13	IM-11-560-19	IM-11-560-25	IM-11-560-32	
Hibbs	Hibbs	Hibbs	Hibbs	Hibbs	
24.5cm 9 3/4"	24.5cm 9 3/4"	24.5cm 9 3/4"	24.5cm 9 3/4"	24.5cm 9 3/4"	
Gouge	Gouge	Gouge	Gouge	Gouge	
6 mm	13 mm	19 mm	25 mm	32 mm	

IM-11-565-06	IM-11-565-13	IM-11-565-19	IM-11-565-25	IM-11-565-32	
Hibbs	Hibbs	Hibbs	Hibbs	Hibbs	
24.5cm 9 3/4"	24.5cm 9 3/4"	24.5cm 9 3/4"	24.5cm 9 3/4"	24.5cm 9 3/4"	
Gouge	Gouge	Gouge	Gouge	Gouge	
6 mm	13 mm	19 mm	25 mm	32 mm	



Bone Surgery



IM-11-570-30
Putti
30cm 11 3/4"
Bone Rasp
round / semi round



IM-11-570-27
Putti
27cm 10 3/4"
Bone Rasp
curved / straight



Bone Surgery

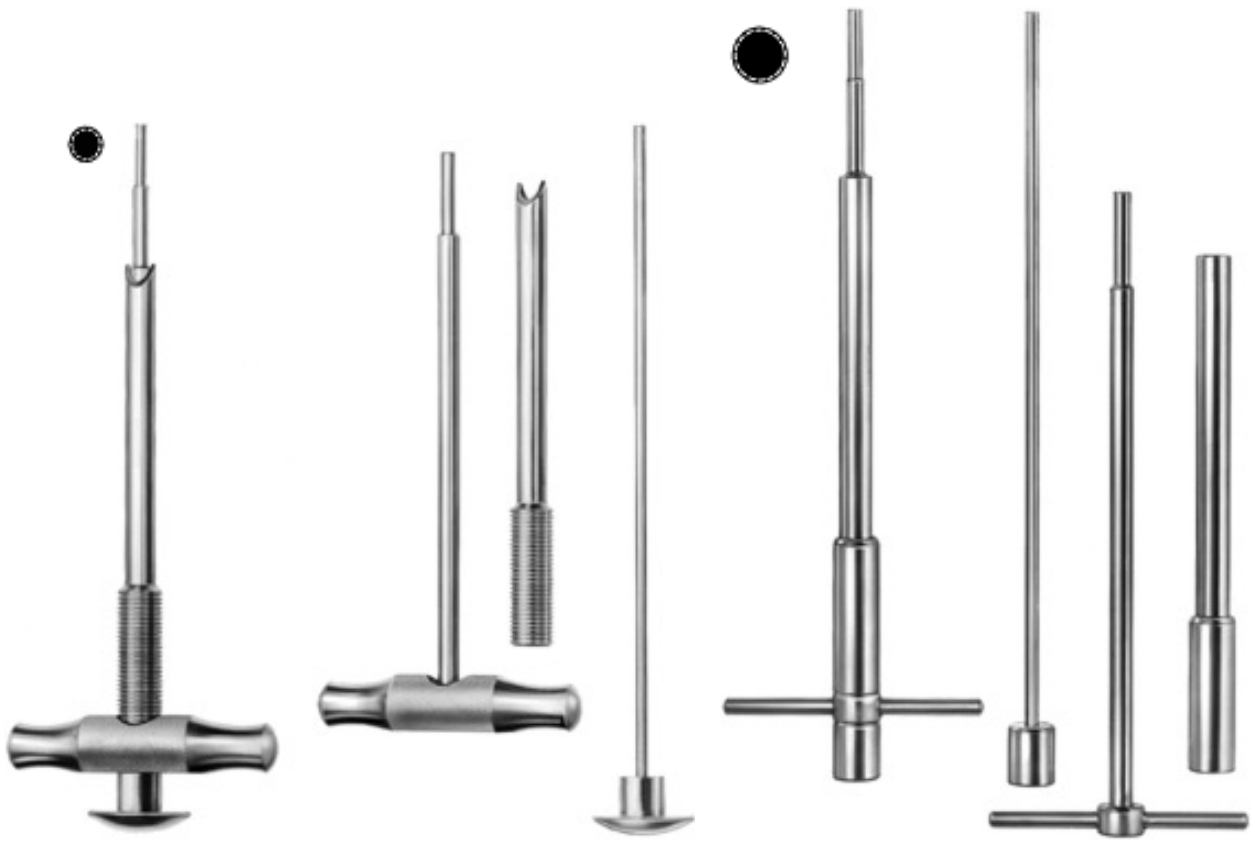

IM-11-575-00
Champy-OSU
22cm 8 3/4"

Bone Biopsy Instrumentouter
Ø 5,0 mm, inner Ø 3,8 mm
Consisting of trocar, a toothed trephine and
a plunger for taking tibial and iliac bone grafts
through a closed technique

IM-11-575-01
Champy
22cm 8 3/4"

Bone Biopsy Instrumentouter
Ø 8 mm inner Ø 7 mm

Bone Surgery

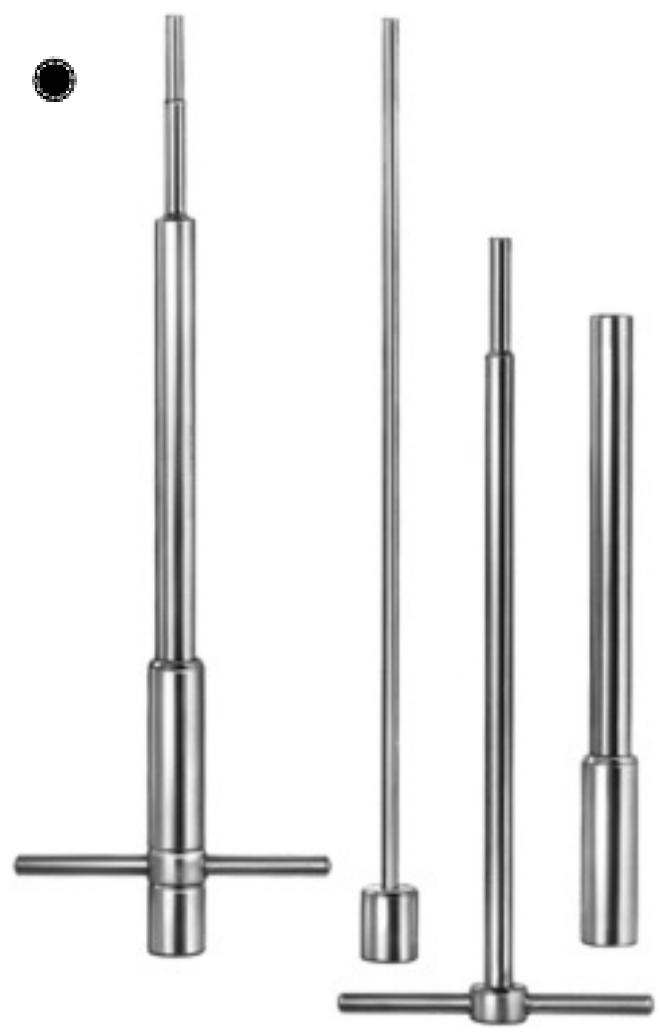

IM-575-02
Champy
22cm 8 3/4"
Bone Biopsy Instrumentouter
Ø 5 mm inner Ø 4 mm

Bone Surgery



IM-11-570-05
22.5cm 8 3/4"
Cancellous Bonegraft Millouter
Ø 17 mm inner Ø 16 mm



IM-11-575-10
Vickers
18cm 7"
Spongiosa Gouge

Bone Surgery



●
IM-11-580-02
15.5cm 6"
Tamper
2 mm Ø

●
IM-11-580-03
15.5cm 6"
Tamper
3 mm Ø

●
IM-11-580-04
15.5cm 6"
Tamper
4 mm Ø

●
IM-11-580-05
15.5cm 6"
Tamper
5 mm Ø

●
IM-11-580-06
15.5cm 6"
Tamper
6 mm Ø

●
IM-11-580-08
15.5cm 6"
Tamper
8 mm Ø

●
IM-11-580-10
15.5cm 6"
Tamper
10 mm Ø

Bone Surgery

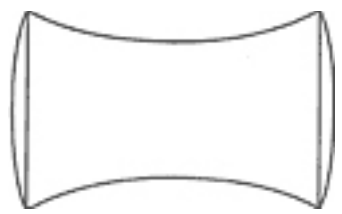

IM-11-585-01
Williger
24cm 9 ½"
Mallet
head 26 mm Ø weight 300 gr.
lead filled

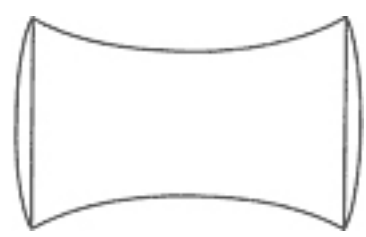

IM-11-585-02
Williger
24cm 9 ½"
Mallet
head 28 mm Ø weight 340 gr.
lead filled

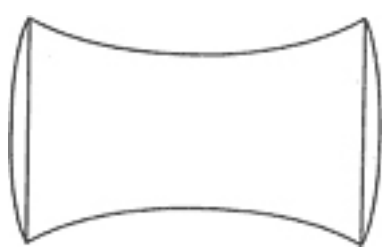

IM-11-585-03
Williger
24cm 9 ½"
Mallet
head 30 mm Ø weight 400 gr.
lead filled

Bone Surgery

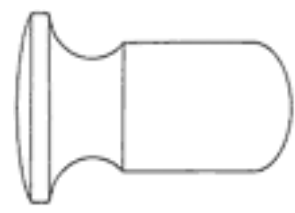

IM-11-590-01
Doyen
20.5cm 8"
Mallehead
25 mm Øweight 120 gr.

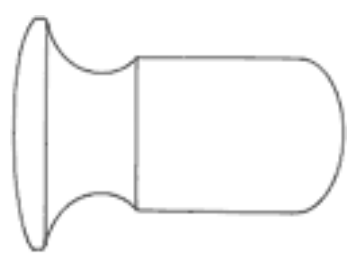

IM-11-590-02
Doyen
21cm 8 1/4"
Mallehead
30 mm Øweight 180 gr.

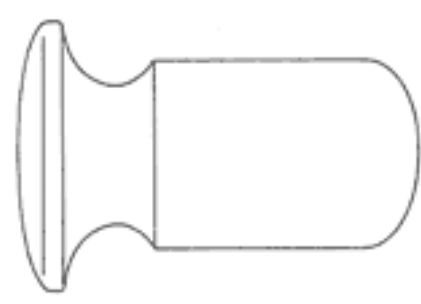

IM-11-590-03
Doyen
21.5cm
8 1/2"
Mallehead
35 mm Øweight 260 gr.

Bone Surgery



IM-11-595-20
Collin
20cm 8"
Mallet
head 30 mm Øweight 220 gr.

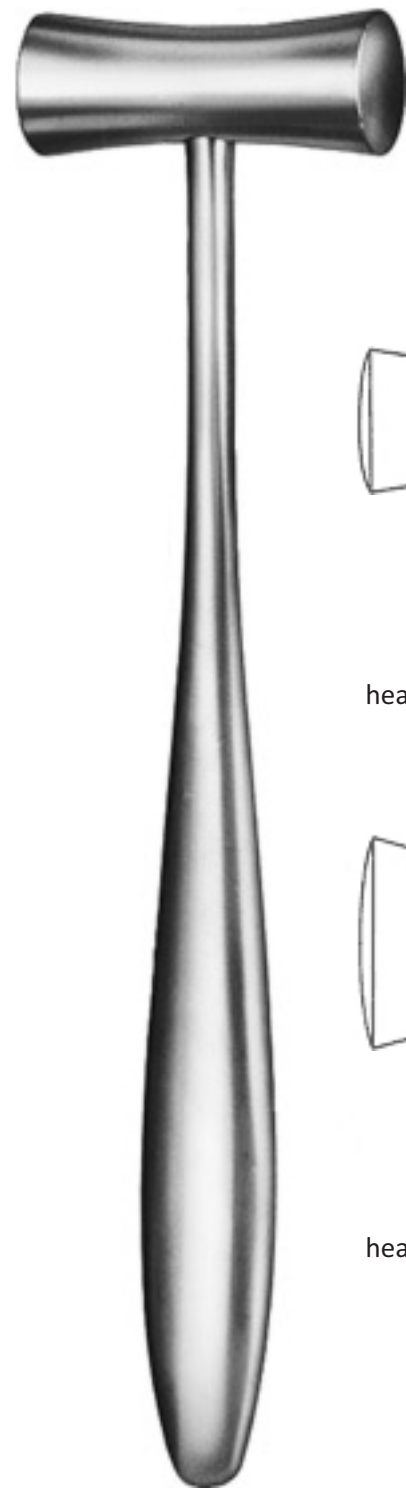

IM-11-597-01
Lucae
19.5cm 7 3/4"
Mallet
head 19 mm Øweight 230 gr.



IM-11-597-02
Lucae
19.5cm 7 3/4"
Mallethead
head 25 mm Øweight 260 gr.

Bone Surgery



IM-11-600-19
Cottle
19cm 7 ½"
Mallet
head 30 mm Øweight 300 gr.



IM-11-605-01
Williger
16.5cm 6 ½"
Mallet
head 20 mm Øweight 140 gr.



IM-11-610-22
26cm 10 1/4"
Mallet
head 30 mm Øweight 510 gr.
plastic handle

plane / convex

Bone Surgery



IM-11-615-17
Mead
19cm 7 ½"
Mallet
head 27 mm Ø weight 320 gr.
with interchangeable plastic disks



IM-11-617-00
Spare Facings
plastic
Spare Facings (pair)



IM-11-620-18
Partsch
19cm 7 ½"
Mallet
head 22 mm Ø weight 200 gr.
with hollow handle

Bone Surgery



IM-11-625-01
26cm 10 1/4"
Mallet
head 42 mm \emptyset weight 400 gr.
made of plastic with lead filling

IM-11-625-02
26cm 10 1/4"
Mallet
head 42 mm \emptyset weight 250 gr.
made of plastic without lead

Bone Surgery



IM-11-630-26
26cm 10 1/4"
Mallet
head 42 mm Ø weight 400 gr.
made of plastic with lead filling



IM-11-635-29
26.5cm 10 1/2"
Mallet
head 30 mm Ø weight 675 gr.
plane (nylon) / convex (steel) plastic handle



IM-11-640-24
26cm 10 1/4"
Mallet
head 42 / 30 mm Ø weight 530 gr.
plastic handle

Bone Surgery



IM-11-645-24
24cm 9 ½"
Mallet
head 30 mm Ø weight 480 gr.
plastic handle



IM-11-650-22
24cm 9 ½"
Mallet
head 37 mm Ø weight 370 gr.
disks and handle of plastic



IM-11-650-00
Spare Facings
plastic Spare Facings (pair)

Bone Surgery



PM-11-655-18
22cm 8 3/4"
Mallet
head 30 mm Ø weight 125 gr.
made of plastic



IM-11-660-01
26.5cm 10 1/2"
Mallet
head 30 mm Ø weight 450 gr.
plastic handle



IM-11-660-02
26.5cm 10 1/2"
Mallet
head 50 mm Ø weight 900 gr.
plastic handle

Bone Surgery



IM-11-665-19
Vickers
19cm 7 ½"
Mallet
head 25 mm Ø weight 300 gr.
nylon disks
plastic handle



IM-11-665-90
Vickers
Spare Facings
plastic (nylon)
Spare Facings (pair)



IM-11-670-19
Herbert
19cm 7 1/2"
Mallet
for ulnar head prosthesis
plastic handle

Bone Surgery



IM-11-675-01
Volkman
18.5cm 7 1/4"
Bone Curette
Fig. 1
oval with plastic handle



IM-11-675-02
Volkman
18.5cm 7 1/4"
Bone Curette
Fig. 2
oval with plastic handle



IM-11-675-03
Volkman
19cm 7 1/4"
Bone Curette
Fig. 3
oval with plastic handle



IM-11-675-04
Volkman
19cm 7 1/4"
Bone Curette
Fig. 4
oval with plastic handle



IM-11-675-05
Volkman
19cm 7 1/4"
Bone Curette
Fig. 5
oval with plastic handle



IM-11-675-06
Volkman
19cm 7 1/2"
Bone Curette
Fig. 6
oval with plastic handle



IM-11-675-10
Volkman
18.5cm 7 1/2"
Bone Curette
Fig. 0
oval
with plastic handle



IM-11-675-20
Volkman
18.5cm 7 1/2"
Bone Curette
Fig. 00
oval
with plastic handle



IM-11-675-30
Volkman
18.5cm 7 1/2"
Bone Curette
Fig. 000
oval
with plastic handle



IM-11-675-40
Volkman
18.5cm 7 1/2"
Bone Curette
Fig. 0000
oval
with plastic handle

Bone Surgery



IM-11-680-01
Volkmann
27.5 cm 10 3/4"
Bone Curette
Fig. 1
oval
with plastic handle



IM-11-680-02
Volkmann
27.5 cm 10 3/4"
Bone Curette
Fig. 2
oval
with plastic handle

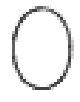

IM-11-680-03
Volkmann
27.5 cm 10 3/4"
Bone Curette
Fig.3
oval
with plastic handle

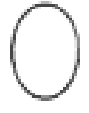

IM-11-680-04
Volkmann
27.5 cm 10 3/4"
Bone Curette
Fig. 4
oval
with plastic handle



IM-11-680-10
Volkmann
27.5cm 10 3/4"
Bone Curette
Fig. 0
oval
with plastic handle

Bone Surgery



IM-11-685-10
Schede
17cm 6 3/4"
Bone Curette
Fig. 0
oval
with hollow handle



IM-11-685-20
Schede
17cm 6 3/4"
Bone Curette
Fig. 00
oval
with hollow handle



IM-11-685-30
Schede
17cm 6 3/4"
Bone Curette
Fig. 000
oval
with hollow handle



IM-11-685-01
Schede
17cm 6 3/4"
Bone Curette
Fig. 1
oval
with hollow handle

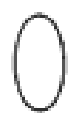

IM-11-685-02
Schede
17cm 6 3/4"
Bone Curette
Fig. 2
oval
with hollow handle

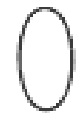

IM-11-685-03
Schede
17cm 6 3/4"
Bone Curette
Fig. 3
oval
with hollow handle



IM-11-685-03
Schede
17cm 6 3/4"
Bone Curette
Fig. 3
oval
with hollow handle

Bone Surgery



IM-11-690-10
Volkman
17cm 6 3/4"
Bone Curette
Fig. 0
oval
with hollow handle



IM-11-690-20
Volkman
17cm 6 3/4"
Bone Curette
Fig. 00
oval
with hollow handle



IM-690-11-30
Volkman
17cm 6 3/4"
Bone Curette
Fig. 000
oval
with hollow handle



IM-11-690-40
Volkman
17cm 6 3/4"
Bone Curette
Fig. 0000
oval
with hollow handle



IM-11-690-01
Volkman
17cm 6 3/4"
Bone Curette
Fig. 1
oval
with hollow handle



IM-11-690-02
Volkman
17cm 6 3/4"
Bone Curette
Fig. 2
oval
with hollow handle

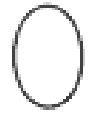

IM-11-690-03
Volkman
17cm 6 3/4"
Bone Curette
Fig. 3
oval
with hollow handle



IM-11-690-04
Volkman
17cm 6 3/4"
Bone Curette
Fig. 4
oval
with hollow handle











IM-11-690-05
Volkman
17cm 6 3/4"
Bone Curette
Fig. 5
oval
with hollow handle



IM-11-690-06
Volkman
17cm 6 3/4"
Bone Curette
Fig. 6
oval
with hollow handle





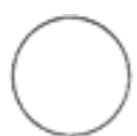



Bone Surgery



- | | | | |
|--|---|--|---|
| 
IM-11-695-10
Bruns
17cm 6 3/4"
Bone Curette
Fig. 0
round
with hollow handle | 
IM-11-695-20
Bruns
17cm 6 3/4"
Bone Curette
Fig. 00
round
with hollow handle | 
IM-11-695-30
Bruns
17cm 6 3/4"
Bone Curette
Fig. 000
round
with hollow handle | 
IM-11-695-40
Bruns
17cm 6 3/4"
Bone Curette
Fig. 0000
round
with hollow handle |
| 
IM-11-695-01
Bruns
Bone Curette
Fig. 1
round
with hollow handle | 
IM-11-695-02
Bruns
Bone Curette
Fig. 2
round
with hollow handle | 
IM-11-695-03
Bruns
Bone Curette
Fig. 3
round
with hollow handle | |
| 
IM-11-695-04
Bruns
Bone Curette
Fig. 4
round
with hollow handle | 
IM-11-695-05
Bruns
Bone Curette
Fig. 5
round
with hollow handle | 
IM-11-695-06
Bruns
Bone Curette
Fig. 6
round
with hollow handle | |

Bone Surgery



- | | | | |
|--|--|--|---|
| 
IM-11-700-10
Spratt
17cm 6 3/4"
Bone Curette
Fig. 0
oval
with hollow handle | 
IM-11-700-20
Spratt
17cm 6 3/4"
Bone Curette
Fig. 00
oval
with hollow handle | 
IM-11-700-30
Spratt
17cm 6 3/4"
Bone Curette
Fig. 000
oval
with hollow handle | 
IM-11-700-40
Spratt
17cm 6 3/4"
Bone Curette
Fig. 0000
oval
with hollow handle |
| 
IM-11-700-01
Spratt
17cm 6 3/4"
Bone Curette
Fig. 1
oval
with hollow handle | | | |
| 
IM-11-700-02
Spratt
17cm 6 3/4"
Bone Curette
Fig. 2
oval
with hollow handle | 
IM-11-700-03
Spratt
17cm 6 3/4"
Bone Curette
Fig. 3
oval
with hollow handle | 
IM-11-700-04
Spratt
17cm 6 3/4"
Bone Curette
Fig. 4
oval
with hollow handle | 
IM-11-700-05
Spratt
17cm 6 3/4"
Bone Curette
Fig. 5
oval
with hollow handle |

Bone Surgery



IM-11-705-10
Bruns
23cm 9"
Bone Curette
Fig. 0
oval solid



IM-11-705-20
Bruns
23cm 9"
Bone Curette
Fig. 00
oval solid



IM-11-705-30
Bruns
23cm 9"
Bone Curette
Fig. 000
oval solid



IM-11-705-01
Bruns
23cm 9"
Bone Curette
Fig. 1
oval solid



IM-11-705-02
Bruns
23cm 9"
Bone Curette
Fig. 2
oval solid



IM-11-705-03
Bruns
23cm 9"
Bone Curette
Fig. 3
oval solid



IM-11-705-04
Bruns
23cm 9"
Bone Curette
Fig.4
oval solid



IM-11-705-05
Bruns
23cm 9"
Bone Curette
Fig. 5
oval solid



IM-11-705-06
Bruns
23cm 9"
Bone Curette
Fig. 6
oval solid

Bone Surgery



IM-11-710-25
Scoville
25cm 9 3/4"
Bone Curette
oval
with hollow handle



IM-11-712-25
Scoville
25cm 9 3/4"
Bone Curette
oval
with hollow handle



IM-10-715-25
Scoville
25cm 9 3/4"
Bone Curette
oval
with hollow handle

Bone Surgery



IM-11-720-01
Simon
25cm 9 3/4"
Bone Curette
Fig. 1
oval
with hollow handle



IM-11-720-02
Simon
25cm 9 3/4"
Bone Curette
Fig. 2
oval
with hollow handle



IM-11-720-03
Simon
25cm 9 3/4"
Bone Curette
Fig. 3
oval
with hollow handle



IM-11-720-04
Simon
25cm 9 3/4"
Bone Curette
Fig. 4
oval
with hollow handle



IM-11-720-05
Simon
25cm 9 3/4"
Bone Curette
Fig. 5
oval
with hollow handle



IM-11-720-06
Simon
25cm 9 3/4"
Bone Curette
Fig. 6
oval
with hollow handle

Bone Surgery



○
IM-11-725-01
Modell USA
16cm 6 1/4"
Bone Curette
Fig. 1
oval
with hollow handle

○
IM-11-725-02
Modell USA
16cm 6 1/4"
Bone Curette
Fig. 2
oval
with hollow handle

○
IM-11-725-03
Modell USA
16cm 6 1/4"
Bone Curette
Fig. 3
oval
with hollow handle

○
IM-11-725-04
Modell USA
16cm 6 1/4"
Bone Curette
Fig. 4
oval
with hollow handle

○
IM-11-725-05
Modell USA
16cm 6 1/4"
Bone Curette
Fig. 5
oval
with hollow handle

○
IM-11-725-06
Modell USA
16cm 6 1/4"
Bone Curette
Fig. 6
oval
with hollow handle

Bone Surgery



○
M-11-730-01
Modell USA
15.5cm 6"
Bone Curette
Fig. 1
oval
with hollow handle

○
IM-11-730-02
Modell USA
15.5cm 6"
Bone Curette
Fig.2
oval
with hollow handle

○
IM-11-730-03
Modell USA
15.5cm 6"
Bone Curette
Fig. 3
oval
with hollow handle

○
IM-11-730-04
Modell USA
15.5cm 6"
Bone Curette
Fig. 4
oval
with hollow handle

○
IM-11-730-05
Modell USA
15.5cm 6"
Bone Curette
Fig. 5
oval
with hollow handle

○
IM-11-730-06
Modell USA
15.5cm 6"
Bone Curette
Fig.6
oval
with hollow handle

Bone Surgery



○
IM-11-735-01
Modell USA
15.5cm 6"
Bone Curette
Fig. 1
oval
with hollow handle

○
IM-11-735-02
Modell USA
15.5cm 6"
Bone Curette
Fig.2
oval
with hollow handle

○
IM-11-735-03
Modell USA
15.5cm 6"
Bone Curette
Fig. 3
oval
with hollow handle

○
IM-11-735-04
Modell USA
15.5cm 6"
Bone Curette
Fig. 4
oval
with hollow handle

○
IM-11-735-05
Modell USA
15.5cm 6"
Bone Curette
Fig. 5
oval
with hollow handle

○
IM-11-735-06
Modell USA
15.5cm 6"
Bone Curette
Fig.6
oval
with hollow handle

Bone Surgery



IM-11-740-01
Halle
21cm 8 1/4"
Bone Curette
Fig. 1
oval, malleable shaft
with hollow handle



IM-11-740-02
Halle
21cm 8 1/4"
Bone Curette
Fig. 2
oval, malleable shaft
with hollow handle



IM-11-740-03
Halle
21cm 8 1/4"
Bone Curette
Fig. 3
oval, malleable shaft
with hollow handle

Bone Surgery



IM-11-745-13
Volkman
12.5cm 5"
Bone Curette, double-ended

IM-11-745-14
Volkman
14.5cm 5 3/4"
Bone Curette, double-ended

IM-11-745-17
Volkman
17cm 6 3/4"
Bone Curette, double-ended

Bone Surgery



IM-11-750-13
Volkman
13cm 5"

Bone Curette, double-ended



IM-11-750-16
Volkman
16cm 6 1/4"

Bone Curette, double-ended



IM-11-750-20
Volkman
20cm 8"

Bone Curette, double-ended

Bone Surgery



IM-11-755-21
21cm 8 1/4"
Bone Curette,
double-ended



IM-11-760-00
Williger
13.5cm 5 1/4"
Bone Curette,
double-ended
Fig. 00/0



IM-11-760-01
Williger
13.5cm 5 1/4"
Bone Curette
double-ended
Fig. 0/1



IM-11-760-12
Williger
13.5cm 5 1/4"
Bone Curette
double-ended
Fig. 1/2

Bone Surgery



IM-11-765-00
Williger
17cm 6 3/4"
Bone Curette,
double-ended
Fig. 00/00
oval



IM-11-765-10
Williger
17cm 6 3/4"
Bone Curette,
double-ended
Fig. 0/0
oval



IM-11-765-11
Williger
17cm 6 3/4"
Bone Curette,
double-ended
Fig. 1/1
oval

Bone Surgery

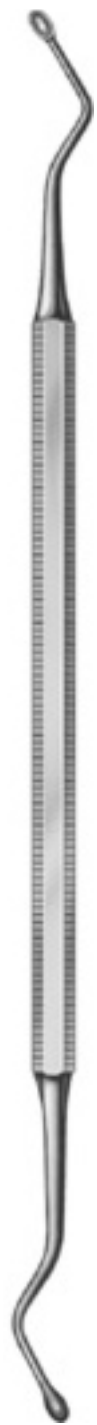

IM-11-770-11
Hemingway-Martin
18.5 cm 7 1/4"
Bone Curette,
double-ended
Fig. 1
R/L octagonal handle

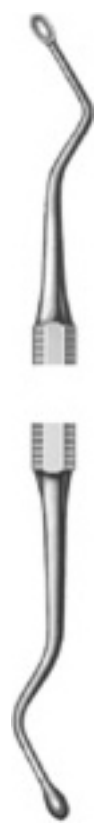

IM-11-770-22
Hemingway-Martin
18.5cm 7 1/4"
Bone Curette,
double-ended
Fig. 2
R/L octagonal handle



IM-11-770-33
Hemingway-Martin
18.5cm 7 1/4"
Bone Curette,
double-ended
Fig. 3
R/L octagonal handle

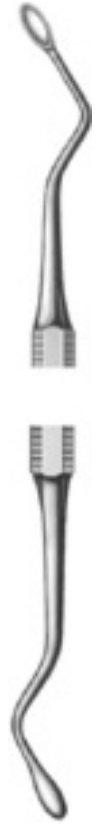

Bone Surgery

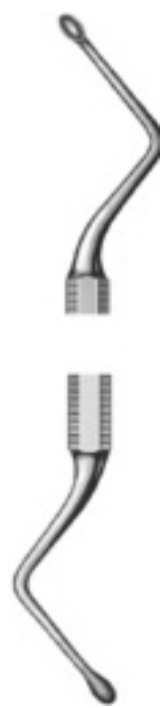
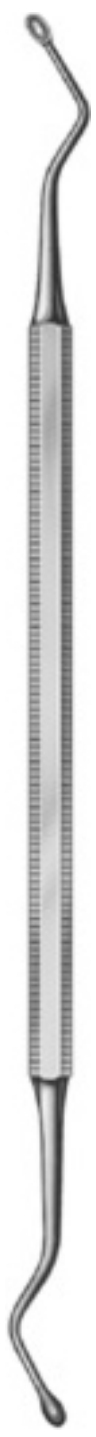

IM-11-775-11
Hemingway
18cm 7"
Bone Curette,
double-ended
Fig. 1 R/L
octagonal handle

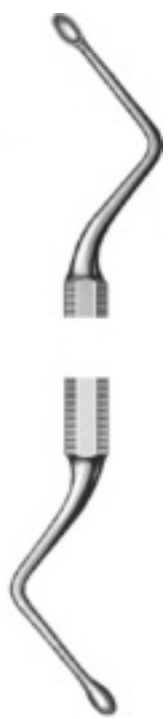

IM-11--775-22
Hemingway
18cm 7"
Bone Curette,
double-ended
Fig. 2 R/L
octagonal handle

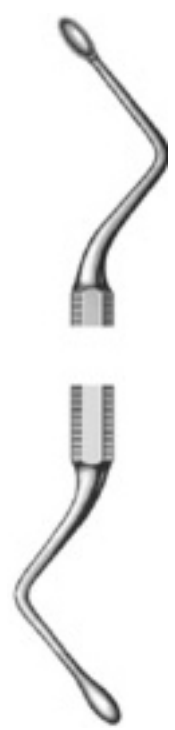

IM-11-775-33
Hemingway
18cm 7"
Bone Curette,
double-ended
Fig. 3 R/L
octagonal handle

Bone Surgery

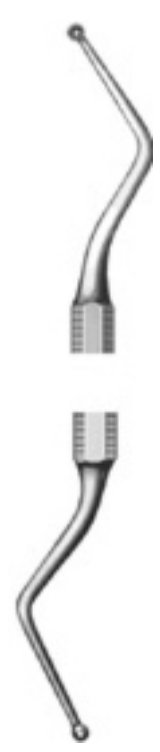
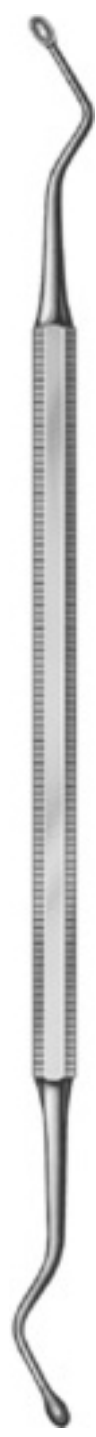

IM-11-780-00
Hemingway
18.5cm 7 1/4"
Bone Curette,
double-ended
Fig. 00/00
octagonal handle



IM-11-780-10
Hemingway
18.5cm 7 1/4"
Bone Curette,
double-ended
Fig. 0/0
octagonal handle



IM-11-780-11
Hemingway
18.5cm 7 1/4"
Bone Curette,
double-ended
Fig. 1/1
octagonal handle

Bone Surgery

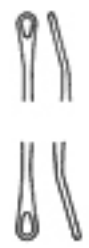

IM-11-785-01
17.5cm 7"
Bone Curette,
double-ended
round

Bone Surgery

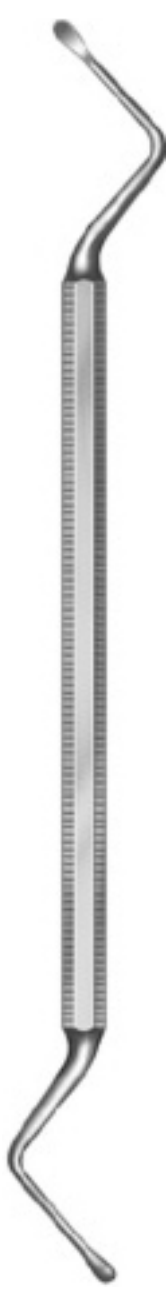

IM-11-790-11
Lucas
18cm 7"
Bone Curette,
double-ended
Fig. 1 R/L
octagonal handle



IM-11-790-22
Lucas
18cm 7"
Bone Curette,
double-ended
Fig. 2 R/L
octagonal handle



IM-11-790-33
Lucas
18cm 7"
Bone Curette,
double-ended
Fig. 3 R/L
octagonal handle



IM-11-790-44
Lucas
18cm 7"
Bone Curette,
double-ended
Fig. 4 R/L
octagonal handle

Bone Surgery

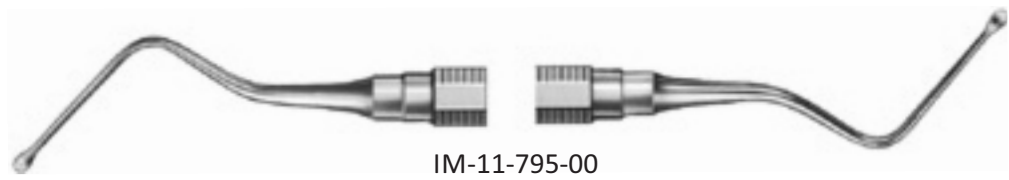
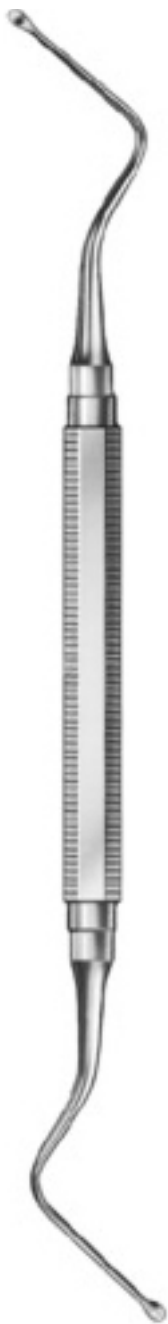

IM-11-795-00
Miller-Colburn
17
Bone Curette,
double-ended
Fig. 0

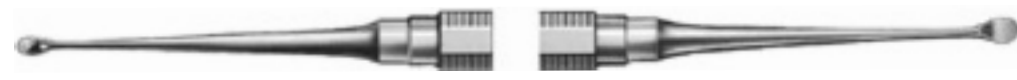

IM-11-795-01
Miller-Colburn
17cm 6 3/4"
Bone Curette,
double-ended
Fig. 1

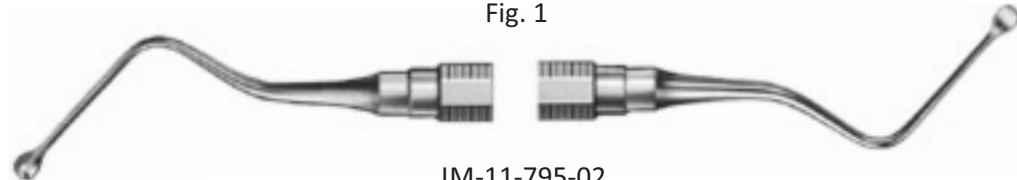

IM-11-795-02
Miller-Colburn
17cm 6 3/4"
Bone Curette,
double-ended
Fig. 2

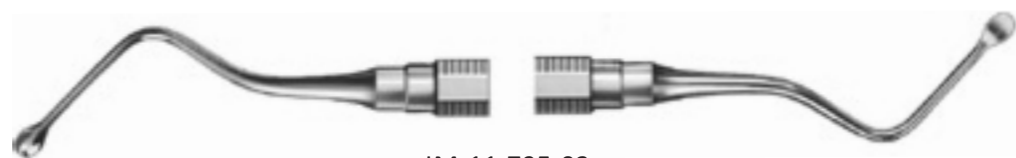

IM-11-795-03
Miller-Colburn
17cm 6 3/4"
Bone Curette,
double-ended
Fig. 3

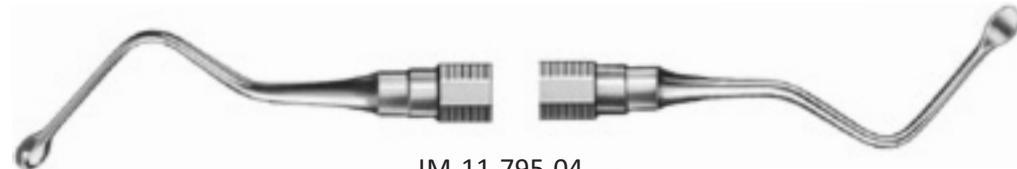

IM-11-795-04
Miller-Colburn
17
Bone Curette,
double-ended
Fig. 4

Bone Surgery



IM-11-800-01
Molt
17cm 6 3/4"
Bone Curette
Fig. 1



IM-11-800-02
Molt
17cm 6 3/4"
Bone Curette
Fig. 2



IM-11-800-04
Molt
17cm 6 3/4"
Bone Curette
Fig. 4



IM-11-800-05
Molt
17.5cm 7"
Bone Curette
Fig. 5



IM-11-800-06
Molt
17.5cm 7"
Bone Curette
Fig. 6

Bone Surgery

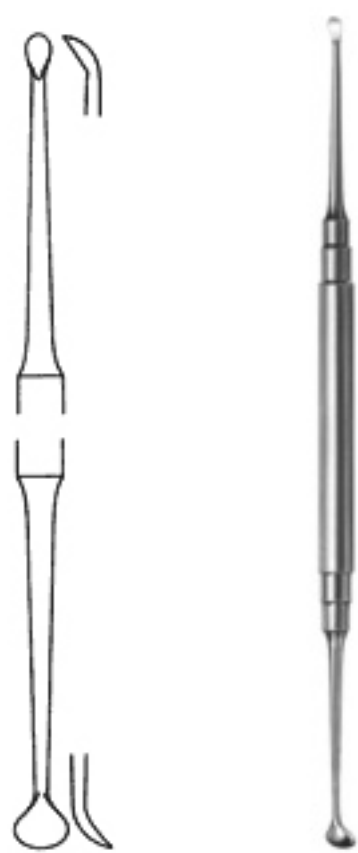

IM-11-805-24
Molt
19cm 7 1/2"
Bone Curette,
double-ended
round handle

Bone Surgery



IM-11-810-01
Martin-Langenbeck
19cm 7 1/2"
Periosteal Elevator
16 mm solid



IM-11-810-02
Martin-Langenbeck
19cm 7 1/2"
Periosteal Elevator
16 mm solid



IM-11-810-03
Martin-Langenbeck
18.5cm 7 1/4"
Periosteal Elevator
12 mm solid



IM-11-810-04
Martin-Langenbeck
18cm 7"
Periosteal Elevator
12 mm solid

Bone Surgery



IM-11-815-10
Martin-Hoen
16cm 6 1/4"
Periosteal Elevator
7 mm
solid



IM-11-815-11
Martin-Hoen
18.5cm 7 1/4"
Periosteal Elevator
15 mm
solid



IM-11-815-12
Martin-Hoen
19cm 7 1/2"
Periosteal Elevator
20 mm
solid

Bone Surgery



IM-11-820-20
Martin-Cushing
17.5cm 7"
Periosteal Elevator
4 mm
solid



IM-11-820-21
Martin-Cushing
17.5cm 7"
Periosteal Elevator
5 mm
solid



IM-11-820-25
Martin-Cushing
19.5cm 7 3/4"
Periosteal Elevator
6 mm
solid



IM-11-820-26
Martin-Cushing
19.5cm 7 3/4"
Periosteal Elevator
7 mm
solid

Bone Surgery



IM-11-825-30
Martin-Cushing
17cm 6 3/4"
Periosteal Elevator
8 mm
solid

Bone Surgery



IM-11-830-18
Langenbeck
18.5cm 7 1/4"
Periosteal Elevator
with hollow handle



IM-11-832-19
Langenbeck
19.5cm 7 3/4"
Periosteal Elevator
with hollow handle

Bone Surgery



IM-11-835-05
16cm 6 1/4"
Periosteal Elevator
5 mm
delicate,
solid



IM-11-835-06
16cm 6 1/4"
Periosteal Elevator
6 mm
delicate,
solid



IM-11-835-07
16cm 6 1/4"
Periosteal Elevator
7 mm
delicate,
solid

Bone Surgery

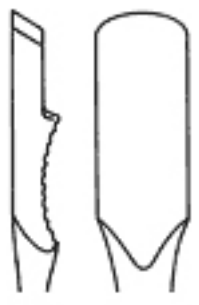

IM-11-840-15
Farabeuf
15cm 6"
Periosteal Elevator
12,5 mm
with hollow handle



IM-11-840-15
Farabeuf
15cm 6"
Periosteal Elevator
12,5 mm
with hollow handle

Bone Surgery



IM-11-845-21
Sedillot
22cm 8 3/4"
Periosteal Elevator
15 mm



IM-11-845-20
20cm 8"
Periosteal Elevator
14 mm
with plastic handle

Bone Surgery



IM-11-850-20
19cm 7 1/2"
Periosteal Elevator
14 mm
with plastic handle



IM-11-850-18
18cm 7"
Periosteal Elevator
6 mm
narrow, con plastic handle

Bone Surgery



IM-11-855-18
18cm 7"
Periosteal Elevator
6 mm
narrow,
con plastic handle



IM-11-860-13
Williger
12.5cm 5"
Periosteal Elevator
5 mm
solid



IM-11-865-18
18cm 7"
Periosteal Elevator
3 mm
extra narrow,
with plastic handle

Bone Surgery



IM-11-870-04
Kahre-Williger
Periosteal Elevator
4 mm



IM-11-870-05
Kahre-Williger
Periosteal Elevator
5 mm

Bone Surgery



IM-11-875-07
Williger
Periosteal Elevator
7 mm



IM-11-875-16
Williger
16cm 6 1/4"
Periosteal Elevator
5 mm
solid

Bone Surgery

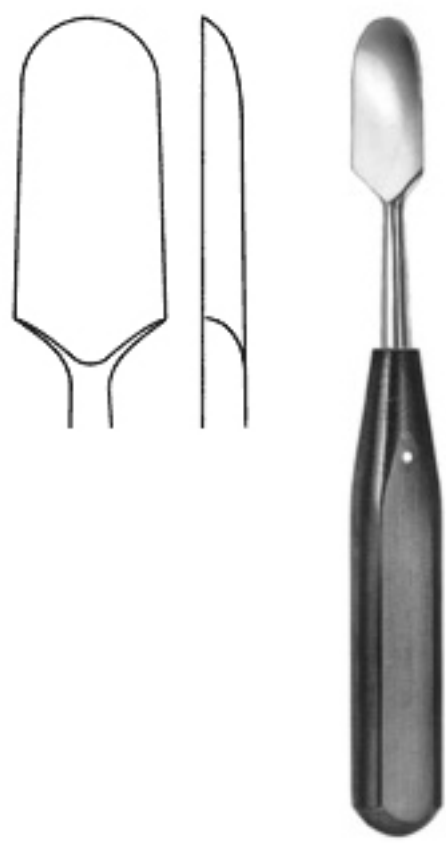

IM-11-880-20
20cm 8"
Periosteal Elevator
19 mm
with plastic handle

Bone Surgery



IM-11-885-06
17cm 6 3/4"
Periosteal Elevator
6 mm
with hollow handle



IM-11-885-08
17cm 6 3/4"
Periosteal Elevator
8 mm

Bone Surgery



IM-11-890-17
Doyen
17.5cm 7"
Rib Raspatory
right curved
for adults
Rib Raspatories
with hollow handle

IM-11-892-17
Doyen
17.5cm 7"
Rib Raspatory
left curved
for adults
Rib Raspatories
with hollow handle

IM-11-894-17
Doyen
17.5cm 7"
Rib Raspatory
right curved
for children
Rib Raspatories
with hollow handle

Bone Surgery



IM-11-895-19
West
18.5cm 7 1/4"
Periosteal Elevator,
double-ended
octagonal handle



IM-11-900-17
Doyen
17.5cm 7"
Rib Raspatory
left curved
for children
Rib Raspatories
with hollow handle



IM-11-905-17
Ohl
17.5cm 7"
Periosteal Elevator,
double-ended

Bone Surgery

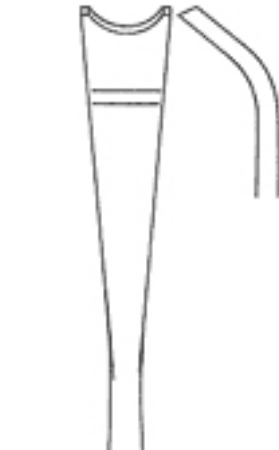

IM-11-910-01
Semb
18.5cm 7 1/4"
Periosteal Elevator
Fig. 1
12 mm



IM-11-910-02
Semb
21.5cm 8 1/2"
Periosteal Elevator
Fig. 2
12 mm

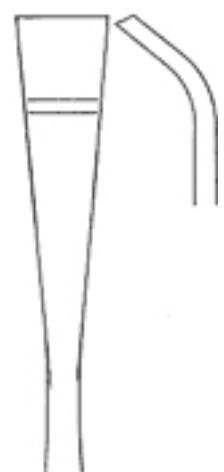

IM-11-910-03
Semb
18.5cm 7 1/4"
Periosteal Elevator
Fig. 3
13 mm



IM-11-910-04
Semb
21.5cm 8 1/2"
Periosteal Elevator
Fig. 4
13 mm



IM-11-910-05
Semb
21cm 8 1/4"
Periosteal Elevator
Fig. 5
15 mm

Bone Surgery



IM-11-915-10
Lambotte
21.5cm 8 1/2"
Periosteal Elevator
10 mm



IM-11-915-15
Lambotte
21.5cm 8 1/2"
Periosteal Elevator
15 mm

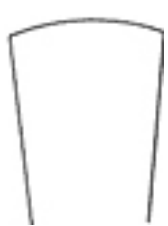

IM-11-915-20
Lambotte
21.5cm 8 1/2"
Periosteal Elevator
20 mm

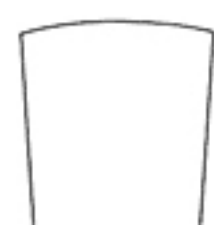

IM-11-915-25
Lambotte
21.5cm 8 1/2"
Periosteal Elevator
25 mm

Bone Surgery

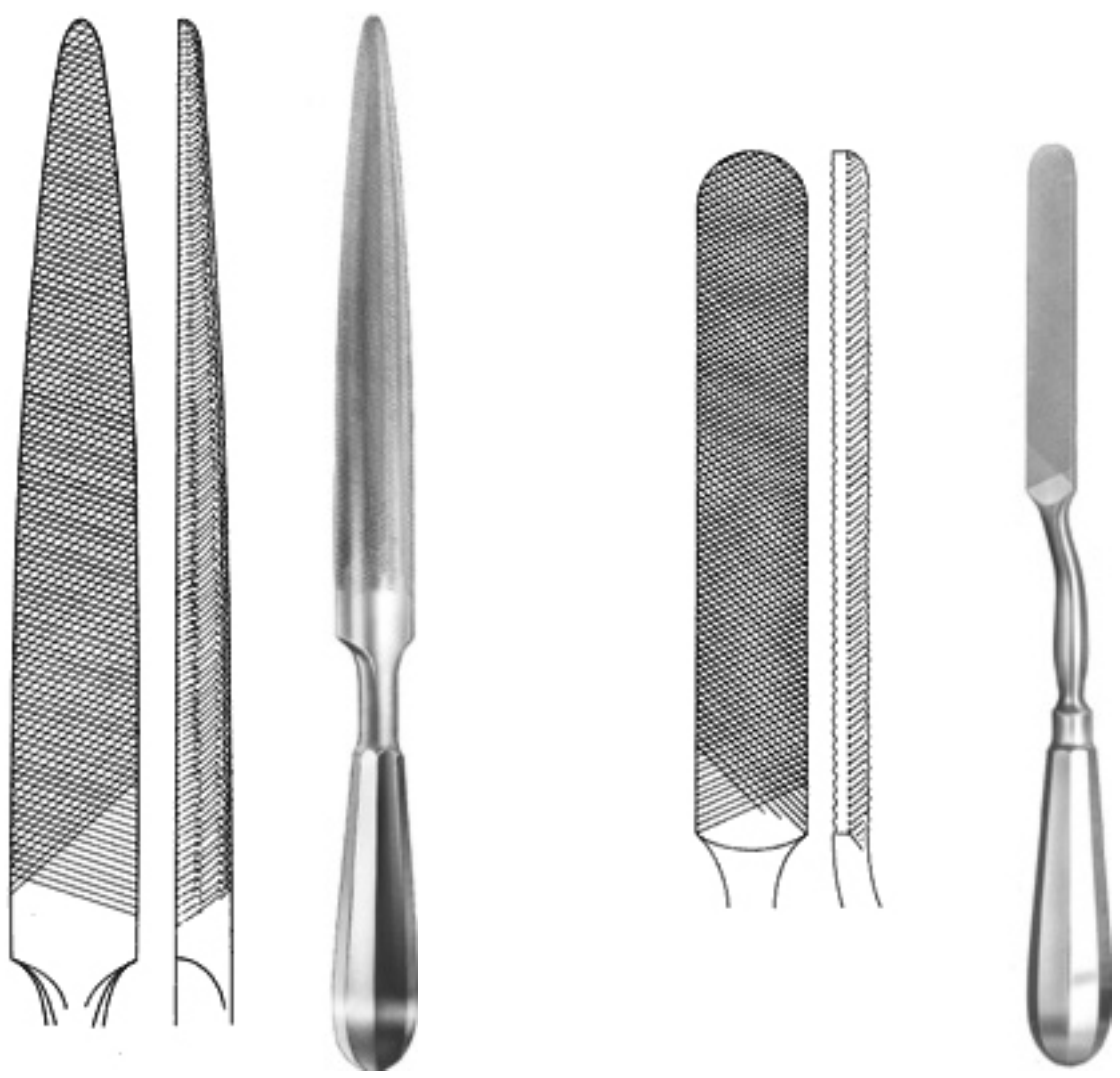

IM-11-920-28
28cm 11"
Bone File semi round
with hollow handle

IM-11-920-24
24.5cm 9 3/4"
Bone File
semi round
with hollow handle

Bone Surgery



IM-11-925-22
22cm 8 3/4"
Bone Fileflat
solid

Bone Surgery



IM-11-930-17
Adson
17cm 6 3/4"
Elevator



IM-11-930-17
Adson
17cm 6 3/4"
Elevator



IM-11-930-17
Adson
17.5cm 7"
Elevator



IM-11-930-17
Adson
17cm 6 3/4"
Elevator

Bone Surgery

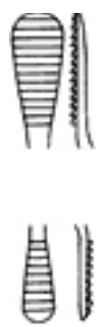
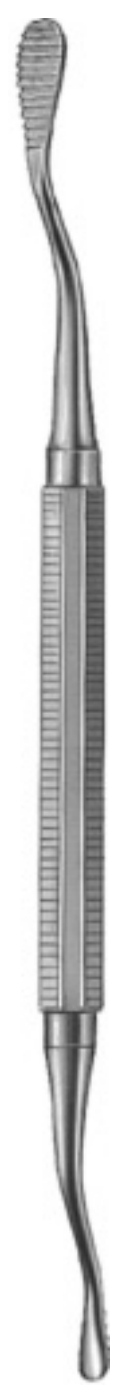

IM-11-935-01
Miller-Colburn
18cm 7"
Bone File
Fig. 1
down wards cutting



IM-11-935-02
Miller-Colburn
18cm 7"
Bone File
Fig. 2
down wards cutting

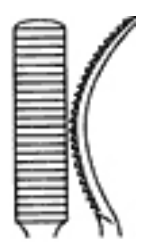

IM-11-935-03
Miller-Colburn
18cm 7"
Bone File
Fig. 3
down wards cutting



IM-11-935-04
Miller-Colburn
18cm 7"
Bone File
Fig. 4
down wards cutting

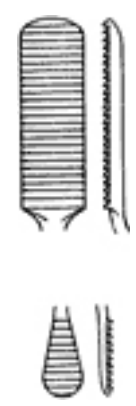

IM-11-935-05
Miller-Colburn
18cm 7"
Bone File
Fig. 5
down wards cutting

Bone Surgery

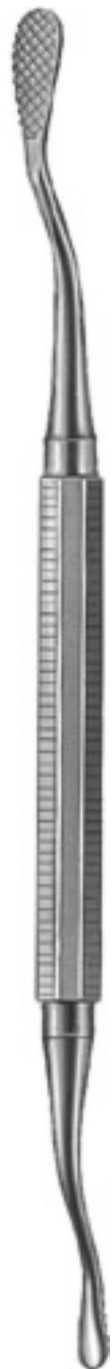

IM-11-940-01
Miller-Colburn
18cm 7"
Bone File
Fig. 1
cross cut



IM-11-940-02
Miller-Colburn
18cm 7"
Bone File
Fig. 2
cross cut



IM-11-940-03
Miller-Colburn
18cm 7"
Bone File
Fig. 3
cross cut

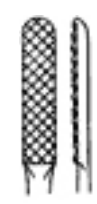

IM-11-940-04
Miller-Colburn
18cm 7"
Bone File
Fig. 4
cross cut

Bone Surgery



IM-11-945-01
Miller
19cm 7 1/2"
Alveotomy File

Bone Surgery

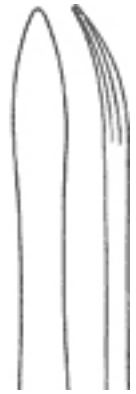

IM-11-950-20
Langenbeck
19.5cm 7 3/4"
Elevator
8 mm



IM-11-952-20
Langenbeck
19.5cm 7 3/4"
Elevator
10 mm

Bone Surgery



IM-11955-01
Martin-Langenbeck
17cm 6 3/4"
Elevator
5 mm



IM-11-955-02
Martin-Langenbeck
17cm 6 3/4"
Elevator
7 mm



IM-11-955-03
Martin-Langenbeck
17cm 6 3/4"
Elevator
8 mm



IM-11-955-04
Martin-Langenbeck
19.5cm 7 3/4"
Elevator
10 mm

Bone Surgery



IM-11-960-17
Vickers
17cm 6 3/4"
Elevator
handle from Titanium

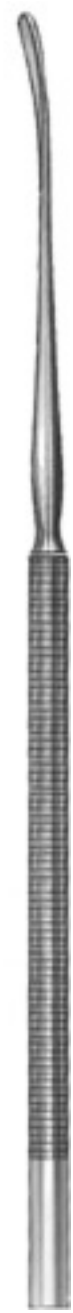

IM-11-962-17
Vickers 17cm 6 3/4"
Dissector
handle from Titanium



IM-11-963-17
Williger 17cm 6 3/4"
Elevator
7 mm



IM-11-964-16
Williger
16cm 6 1/4"
Elevator
5,5 mm

Bone Surgery

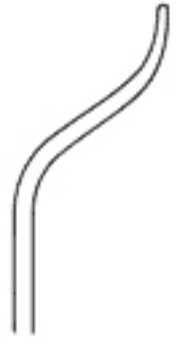

IM-11-965-17
17cm 6 3/4"
Elevator
extremely light
weight

IM-11-965-16
16cm 6 1/4"
Micro Elevator

IM-11-970-16
16cm 6 1/4"
Phalangeal Elevator

Bone Surgery

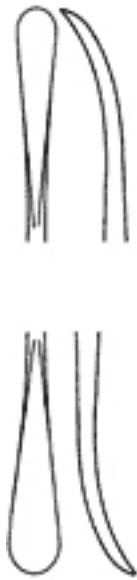

IM-11-975-21
Alderdyce
21cm 8 1/4"
Dissector, double-ended



IM-11-980-19
McDonald
18.5cm 7 1/4"
Dissector, double-ended

Bone Surgery



IM-11-982-06
16cm 6 1/4"
Bone Lever



IM-11-985-06
Hohman, mini
166cm 6 1/4"
Bone Lever
6 mm



IM-11-985-08
Hohman, mini
166cm 6 1/4"
Bone Lever
8 mm

Bone Surgery



IM-11-990-15
16cm 6 1/4"
Bone Lever
14 mm

IM-11-995-16
12cm 4 3/4"
Bone Lever
14 mm

Bone Surgery



IM-11-1000-08
Hohmann
22cm 8 3/4"
Bone Lever
8 mm
narrow tip

IM-11-1000-18
Hohmann
23.5cm 9 1/4"
Bone Lever
18 mm
narrow tip

Bone Surgery

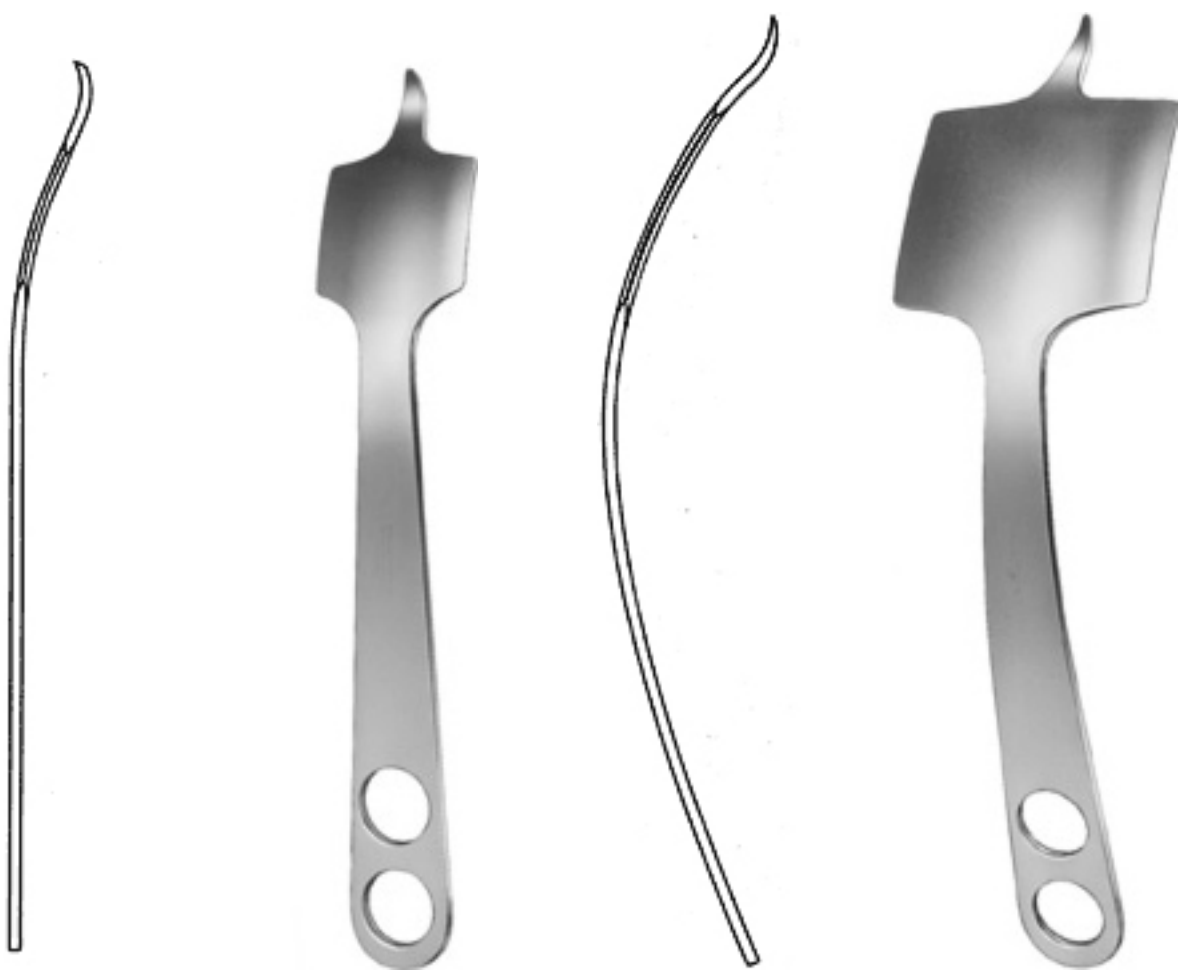

IM-11-1005-43
Hohmann
23.5cm 9 1/4"
Bone Lever
43 mm
narrow tip

IM-11-1005-70
Hohmann
25cm 9 3/4"
Bone Lever
70 mm
narrow tip

Bone Surgery



IM-11-1010-43
Hohmann
23.5cm 9 1/4"
Bone Lever
43 mm
narrow tip

Bone Surgery

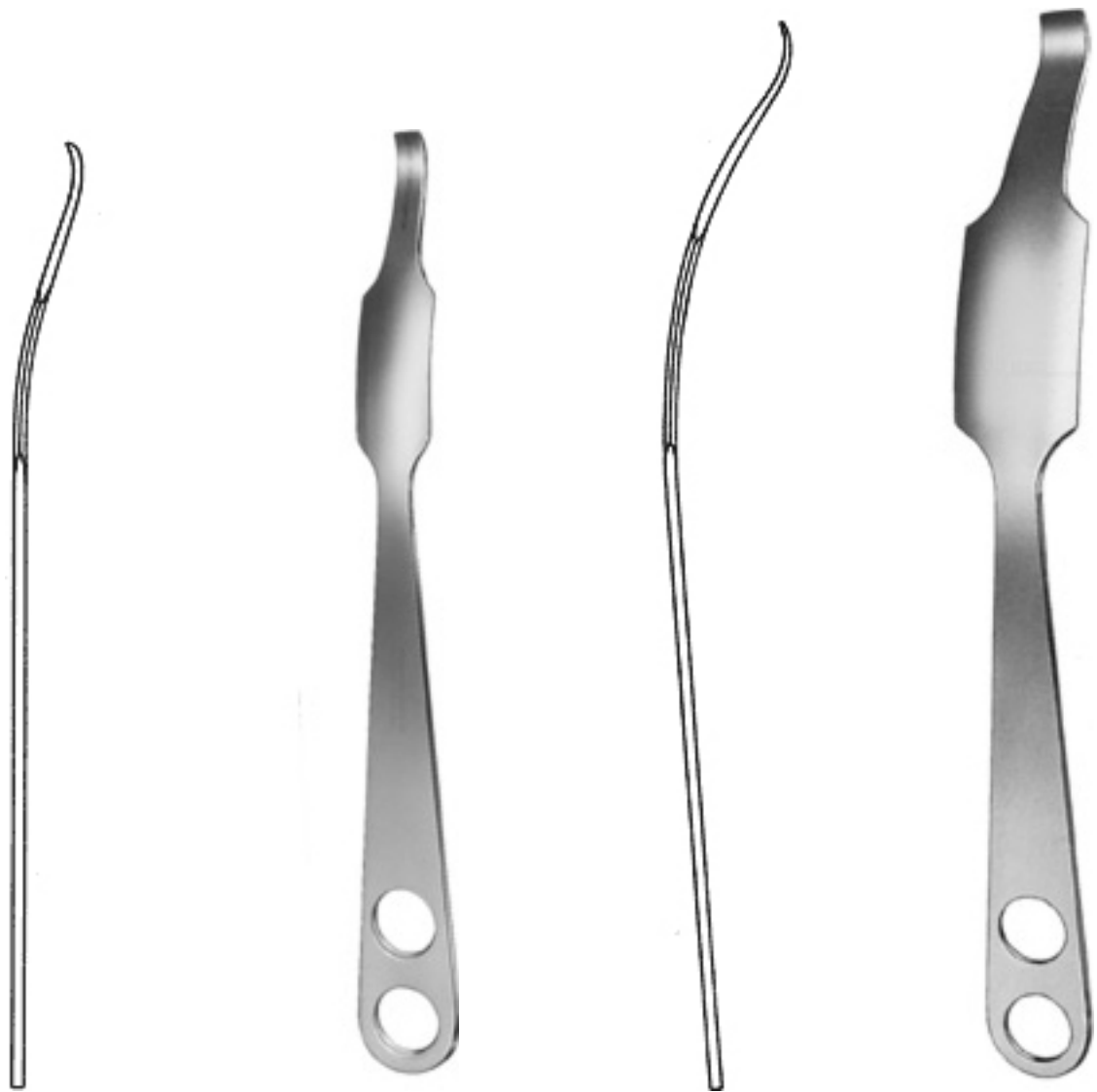

IM-11-1015-22
Hohmann
25.5cm 10"
Bone Lever
22 mm
wide tip

IM-11-1015-35
Hohmann
29cm 11 ½"
Bone Lever
35 mm
wide tip

Bone Surgery



IM-11-1020-24
Hohmann
27.5cm 10 3/4"
Bone Lever
24 mm
wide, round tip

IM-11-1020-22
Lange-Hohmann
25cm 9 3/4"
Bone Lever
22 mm
wide tip with groove

Bone Surgery

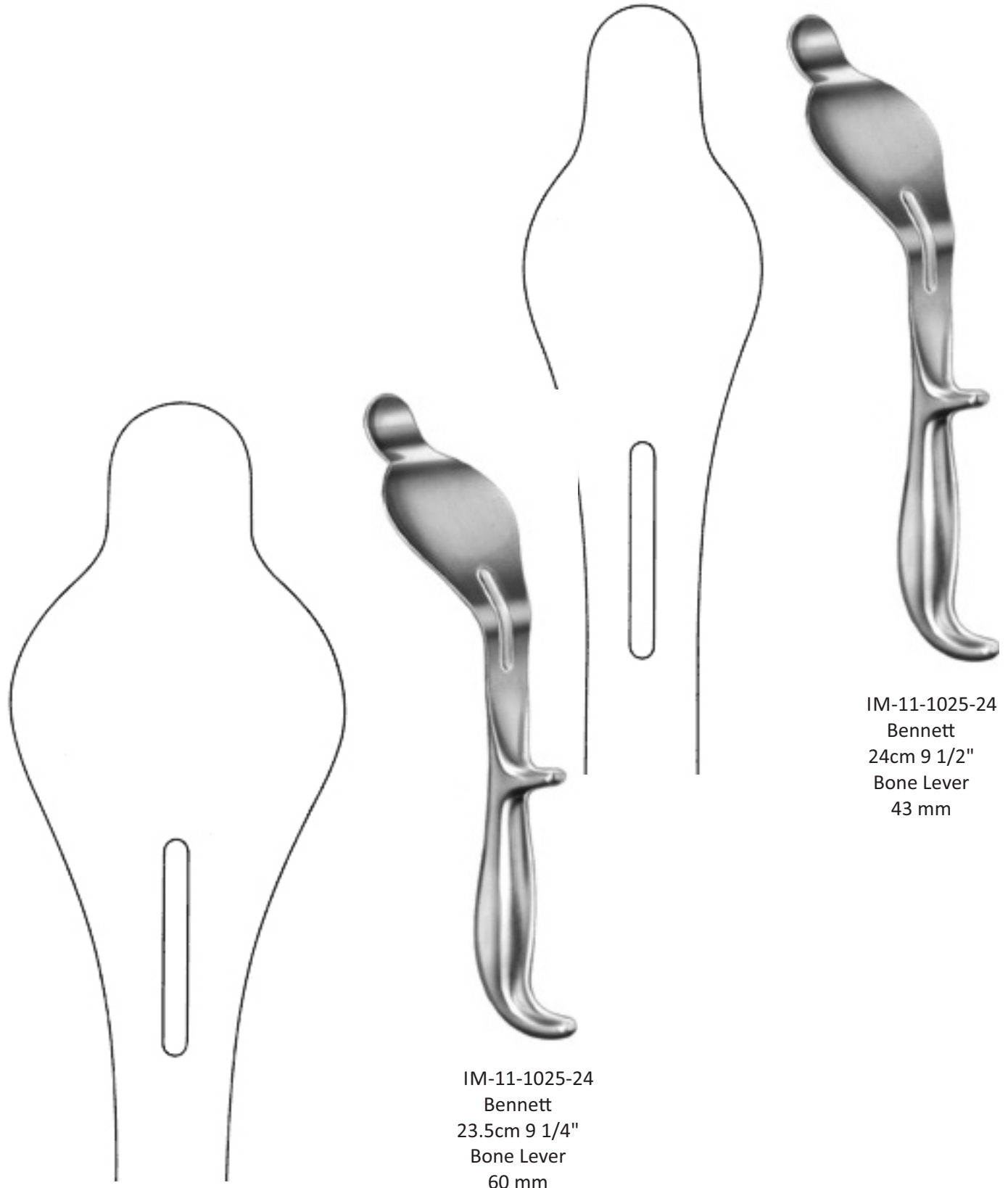

IM-11-1025-24
Bennett
24cm 9 1/2"
Bone Lever
43 mm

IM-11-1025-24
Bennett
23.5cm 9 1/4"
Bone Lever
60 mm

Bone Surgery



IM-11-1030-26
Blount
26.5cm 10 ½"
Knee Retractor
blunt



IM-11-1032-26
Blount
26.5cm 10 ½"
Knee Retractor

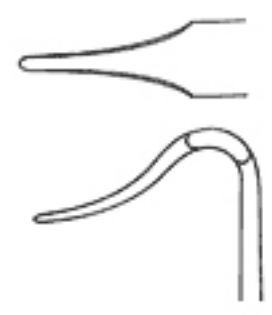

IM-11-1035-17
Blount
17.5cm 7"
Knee Retractor

Bone Surgery

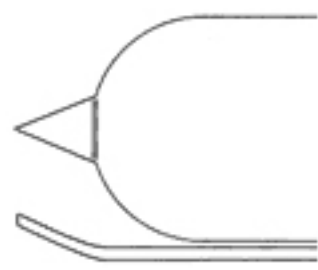

IM-11-1040-16
Taylor
16cm 6 1/4"
Spinal Retractor
75 x 30 mm
pointed end

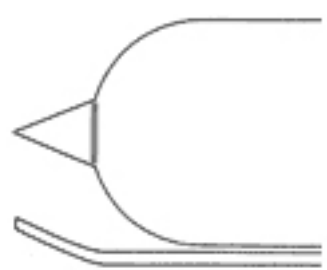
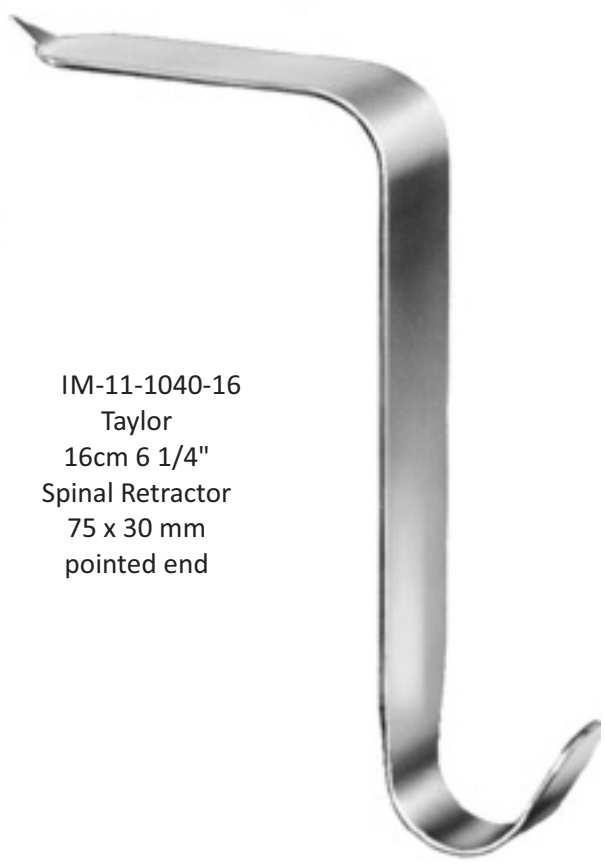

IM-11-1042-16
Taylor
16cm 6 1/4"
Spinal Retractor
100 x 30 mm
pointed end



Bone Surgery

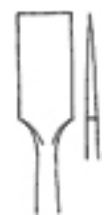

IM-11-1045-17
Smillie
17.5cm 7"
Meniscus Knife



IM-11-1046-17
Smillie
17.5cm 7"
Meniscus Knife



IM-1047-17
Smillie
17.5cm 7"
Meniscus Knife

Bone Surgery



IM-11-1050-18
18cm 7"
Meniscus Knife



IM-11-1055-22
Neff
22cm 8 3/4"
Meniscus Knife



IM-11-1060-22
Neff
22cm 8 3/4"
Meniscus Knife

Bone Surgery



IM-11-1065-22
Salenius
21cm 8 1/4"
Meniscus Knife



IM-11-1066-22
Salenius
21cm 8 1/4"
Meniscus Knife

Bone Surgery



○
IM-11-1070-01
Bunnell
15cm 6"
Tendon Stripper
Fig. 1

○
IM-11-1070-02
Bunnell
15cm 6"
Tendon Stripper
Fig. 2

○
IM-11-1070-03
Bunnell
15cm 6"
Tendon Stripper
Fig. 3

○
IM-11-1070-04
Bunnell
15cm 6"
Tendon Stripper
Fig. 4

○
IM-11-1070-05
Bunnell
15cm 6"
Tendon Stripper
Fig. 5

Bone Surgery



IM-11-1075-40
23cm 9"
Tendon Stripper
flexible shaft



IM-11-1075-45
23cm 9"
Tendon Stripper
flexible shaft



IM-11-1075-55
23cm 9"
Tendon Stripper
flexible shaft

Bone Surgery



IM-11-1080-00
33.5cm 13 1/4"
Tendon Passing Instrument



IM-11-1080-01
Screw



IM-11-1085-31
Fischer
31cm 12 1/4"
Tendon Stripper
blunt

Bone Surgery



IM-1090-29
28.5cm 11 1/4"
Tendon Stripper



IM-11-1095-23
Bunnell
23cm 9"
Tendon Passer
malleable

Bone Surgery

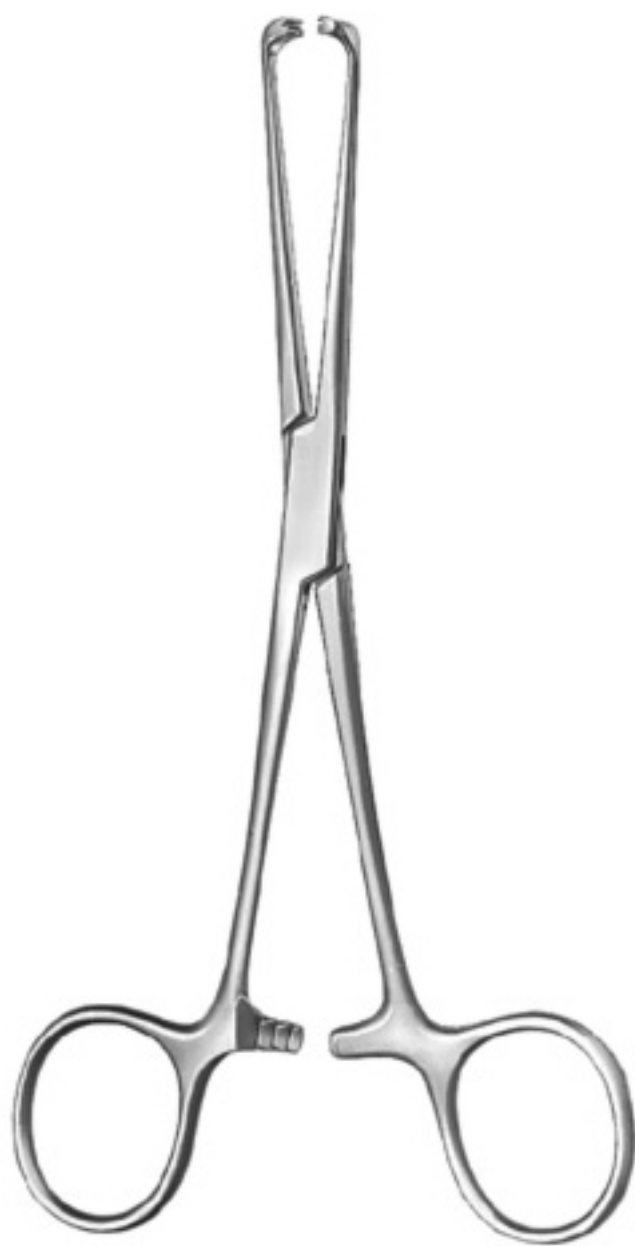
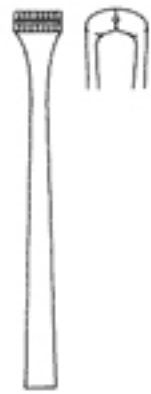

IM-11-1100-16
Steinmann
16cm 6 1/4"
Tendon Holding Forceps

Bone Surgery

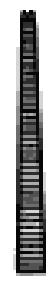
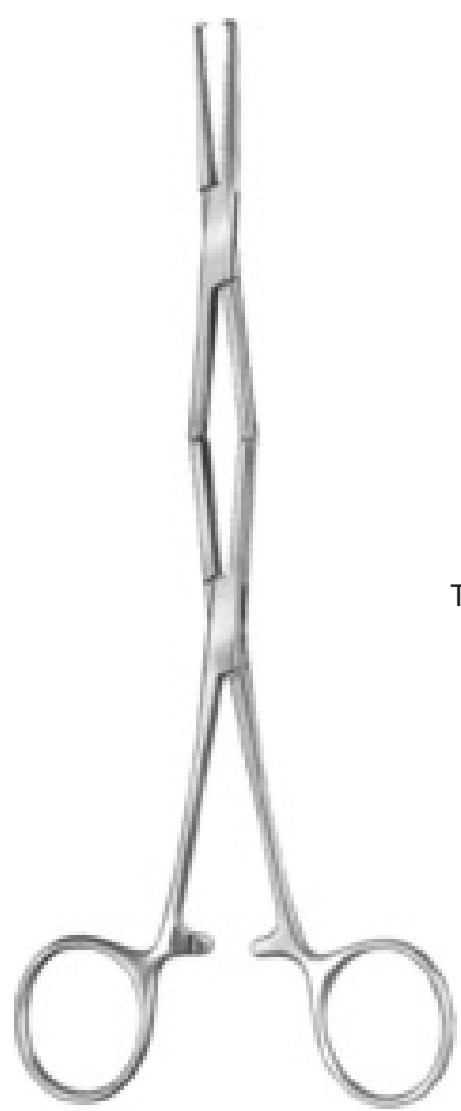

IM-11-1105-00
21cm 8 1/4"
Tendon Tunnelling
Forceps
1:2 teeth



IM-11-1105-01
21cm 8 1/4"
Tendon Tunnelling
Forceps
1:2 teeth

Bone Surgery



IM-11-1110-11
Carrol
111.5cm 4 1/2"
Tendon Holding Forceps

Bone Surgery

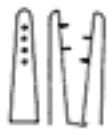

IM-11-1115-13
11.5cm 4 1/2"
Tendon Holding Forceps

Bone Surgery



IM-11-1120-15
15.5cm 6"
Tendon Interlacing Forceps
pointed

Bone Surgery

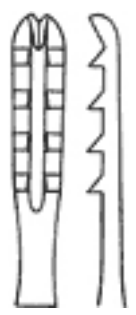
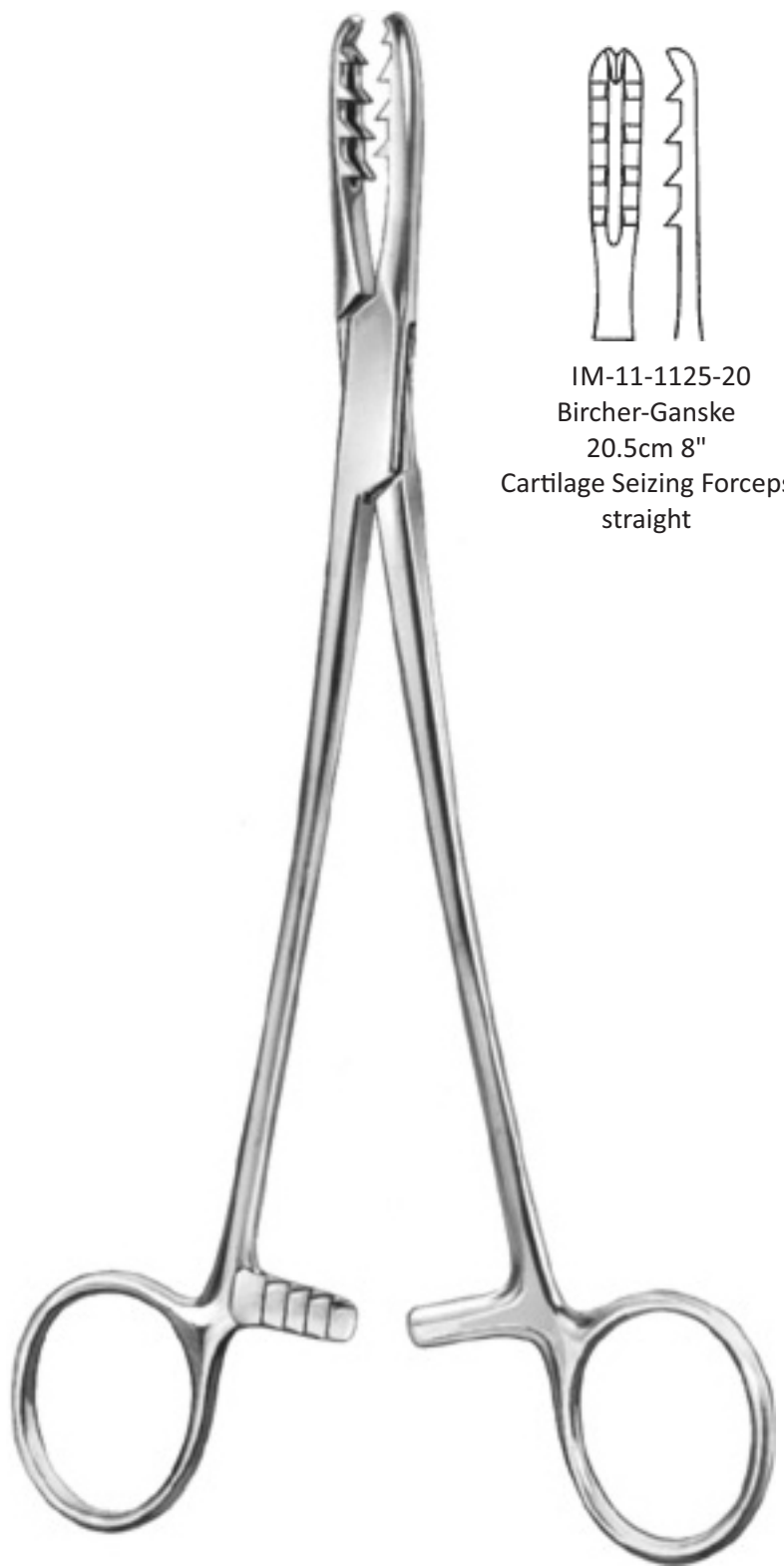

IM-11-1125-20
Bircher-Ganske
20.5cm 8"
Cartilage Seizing Forceps
straight

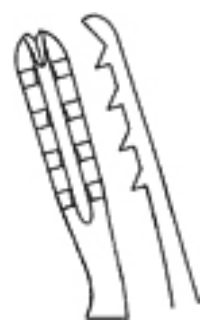

IM-11-1126-20
Bircher-Ganske
20.5cm 8"
Cartilage Seizing Forceps
curved upwards

Bone Surgery

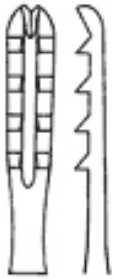

IM-11-1130-20
Bircher-Ganske
20cm 8"
Cartilage Seizing Forceps
curved side wards

Bone Surgery



IM-11-1135-19
Dingmann
18.5cm 7 1/4"
Cartilage Seizing Forceps

Bone Surgery



IM-11-1140-19
Martin
18.5cm 7 1/4"
Cartilage Seizing Forceps



IM-11-1145-12
13.5cm 5 1/4"
Reposition Forceps
long ratchet pointed

Bone Surgery

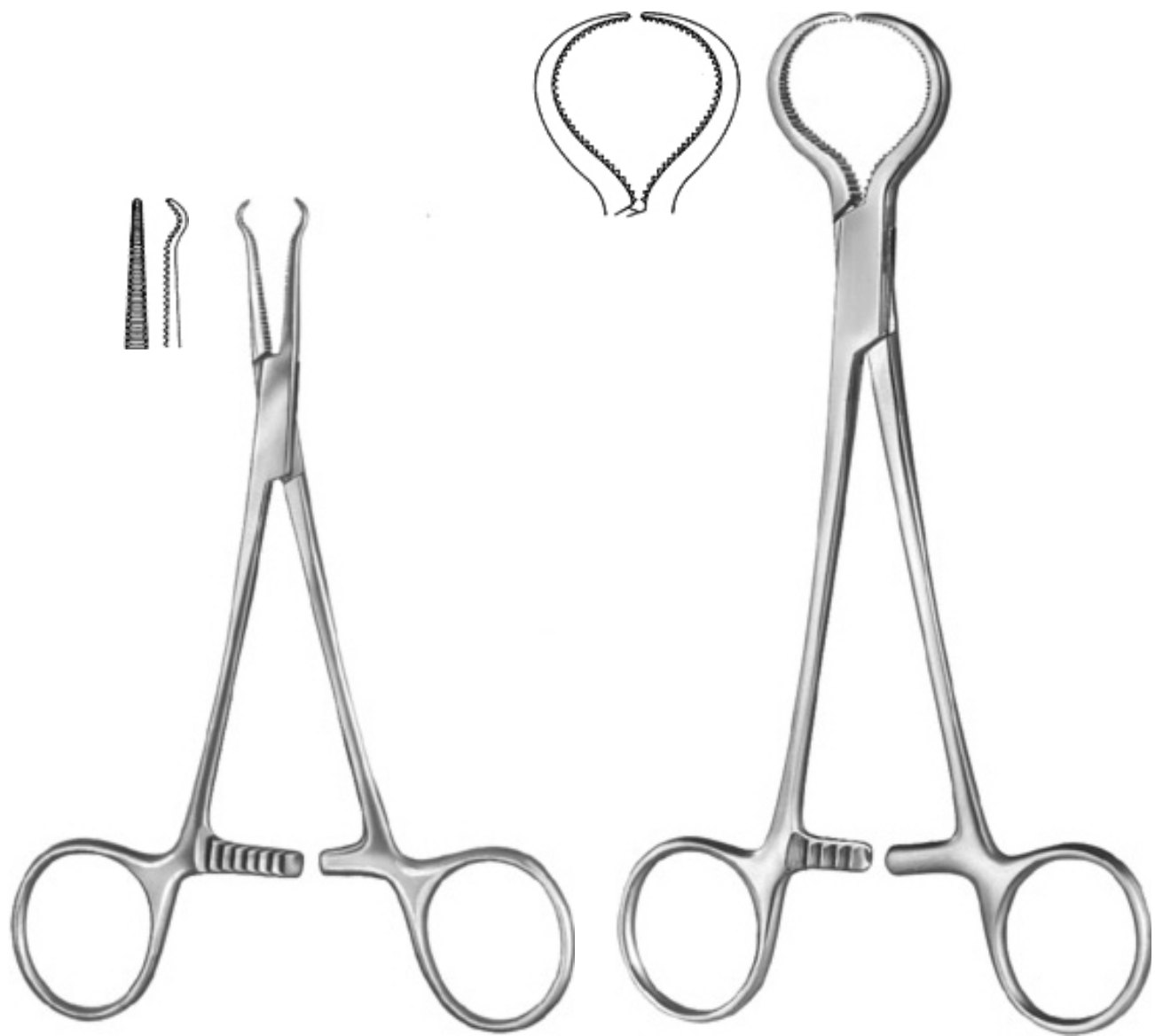

IM-11-1150-17
Lewin
18.5cm 7 1/4"
Bone Holding Forceps

IM-11-1155-13
14cm 5 1/2"
Bone Holding Forceps
delicate

Bone Surgery



IM-11-1160-14
15cm 6"
Reposition Forceps
long ratchet
pointed



IM-11-1165-21
Langenbeck
21cm 8 1/4"
Bone Holding Forceps

Bone Surgery



IM-11-1175-21
Fergusson
21cm 8 1/4"
Bone Holding Forceps
heavy pattern



IM-11-1180-18
Frosch
18cm 7"
Bone Holding Forceps

Bone Surgery

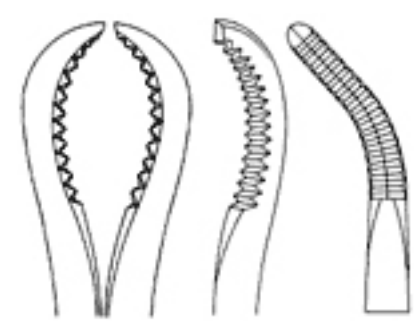

IM-11-1190-16
17cm 6 3/4"
Reposition Forceps
with thread fixation

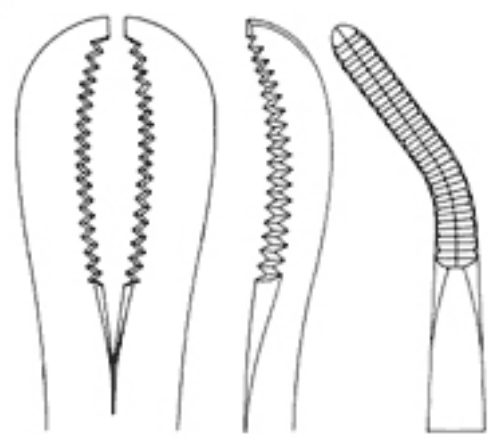

IM-11-1190-24
24cm 9 1/2"
Reposition Forceps
with thread fixation



IM-11-1185-20
20cm 8"
Bone Holding Forceps



Bone Surgery

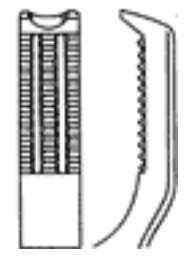
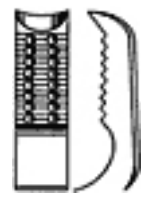
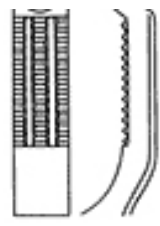

IM-11-1195-17
Kern
17cm 6 3/4"
Bone Holding Forceps

IM-11-1195-21
Kern
21cm 8 1/4"
Bone Holding Forceps

Bone Surgery

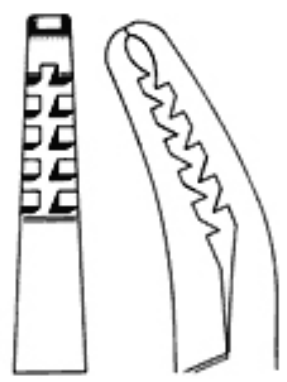

IM-11-1200-19
Semb
19cm 7 1/2"
Bone Holding Forceps
curved sideways

Bone Surgery

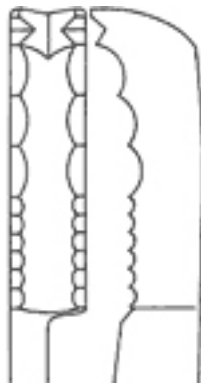

IM-11-1205-23
Farabeuf
23cm 9"
Bone Holding Forceps

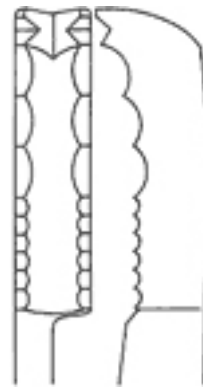

IM-11-1205-26
Farabeuf
26cm 10 1/4"
Bone Holding Forceps

Bone Surgery

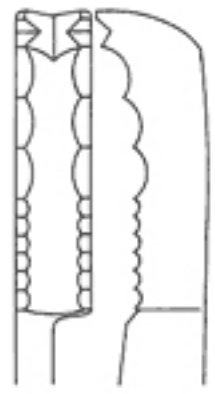

IM-11-1210-26
Farabeuf
26cm 10 1/4"
Bone Holding Forceps

Bone Surgery



PM-11-1215-22
Lambotte
22cm 8 3/4"
Bone Holding Forceps
one flexible jaw



IM-11-1215-27
Lambotte
27cm 10 3/4"
Bone Holding Forceps
one flexible jaw



IM-11-1215-30
Lambotte
30cm 11 3/4"
Bone Holding Forceps
one flexible jaw

Bone Surgery



IM-11-1220-23
Ulrich
23cm 9"
Bone Holding Forceps
with thread fixation



IM-11-1220-25
Ulrich
25cm 9 3/4"
Bone Holding Forceps
with thread fixation



IM-11-1220-28
Ulrich
28cm 11"
Bone Holding Forceps
with thread fixation

Bone Surgery



IM-11-1225-23
Ulrich
22cm 8 3/4"
Bone Holding Forceps
with thread fixation



IM-11-1225-25
Ulrich
24cm 9 1/2"
Bone Holding Forceps
with thread fixation



IM-11-1225-28
Ulrich
27cm 10 3/4"
Bone Holding Forceps
with thread fixation

Bone Surgery



IM-11-1230-15
15cm 6"
Bone Holding Forceps
self-centering
with thread fixation



IM-11-1230-19
19cm 7 1/2"
Bone Holding Forceps
self-centering
with thread fixation



IM-44-1230-23
24cm 9 1/2"
Bone Holding Forceps
self-centering
with thread fixation



IM-11-1230-26
26cm 10 1/4"
Bone Holding Forceps
self-centering
with thread fixation

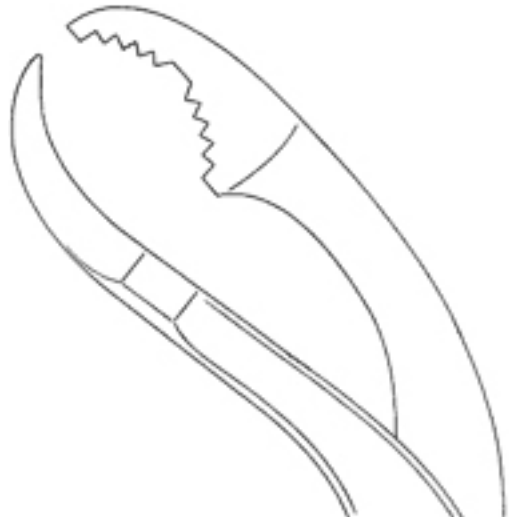

IM-11-1230-28
28cm 11"
Bone Holding Forceps
self-centering
with thread fixation

Bone Surgery

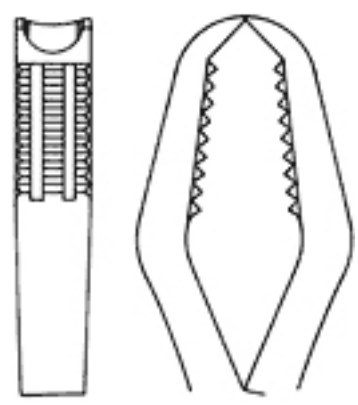

IM-11-1235-33
Lane
33cm 13"
Bone Holding Forceps
without ratchet

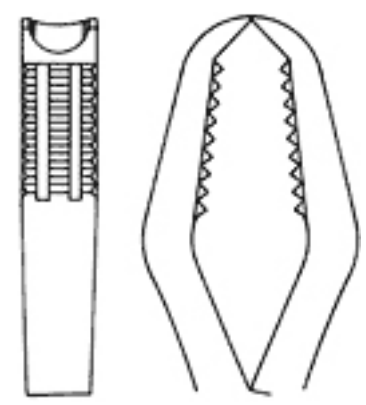

IM-11-1236-33
Lane
33cm 13"
Bone Holding Forceps
with ratchet

Bone Surgery



IM-11-1240-01
Verbrugge
25cm 9 3/4"
Bone Holding Forceps

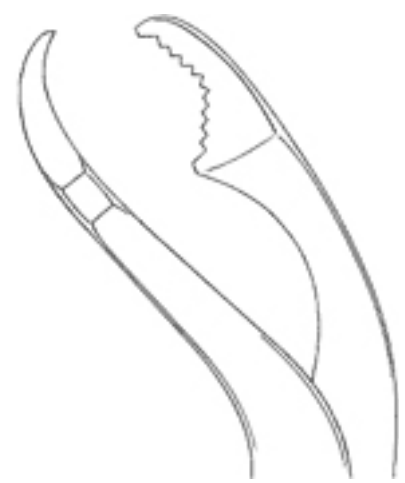

IM-11-1240-02
Verbrugge
26cm 10 1/4"
Bone Holding Forceps

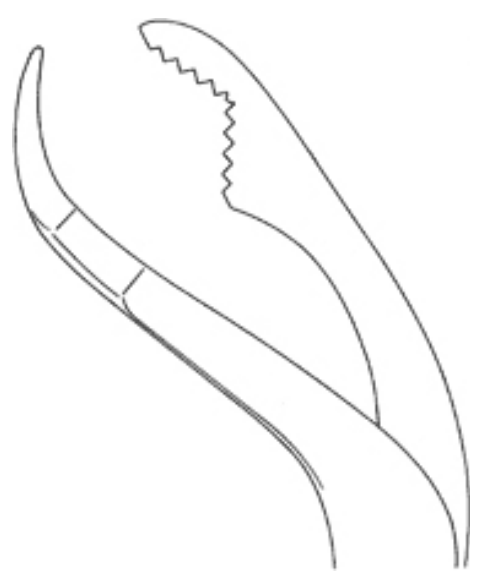

IM-11-1240-03
Verbrugge
27cm 10 3/4"
Bone Holding Forceps

Bone Surgery



IM-11-1245-01
Verbrugge
17.5cm 7"
Bone Holding Forceps

Bone Surgery



IM-11-1250-30
Percy
Amputation
Retractor
detachable

Bone Surgery



IM-11-1255-01
Stellbrink
17.5cm 7"
Bone Rongeur



IM-11-1255-02
Stellbrink
16.5cm 6 1/2"
Bone Rongeur

Bone Surgery



IM-11-1260-12
Friedmann
12.5cm 5"
Bone Rongeur



IM-11-1260-14
Friedmann
13.5cm 5 1/4"
Bone Rongeur

Bone Surgery



IM-11-1265-14
Friedmann
13.5cm 5 1/4"
Bone Rongeur



IM-11-1270-13
Cleveland
13.5cm 5 1/4"
Bone Rongeur

Bone Surgery



IM-11-1275-17
Cleveland
16.5cm 6 1/2"
Bone Rongeur



IM-11-1280-16
Mead
16.5cm 6 1/2"
Bone Rongeur

Bone Surgery



IM-11-1285-18
Hartmann
17.5cm 7"
Bone Rongeur



IM-11-1290-18
ansen
18cm 7"
Bone Rongeur



IM-11-1295-18
Jansen
18cm 7"
Bone Rongeur

Bone Surgery

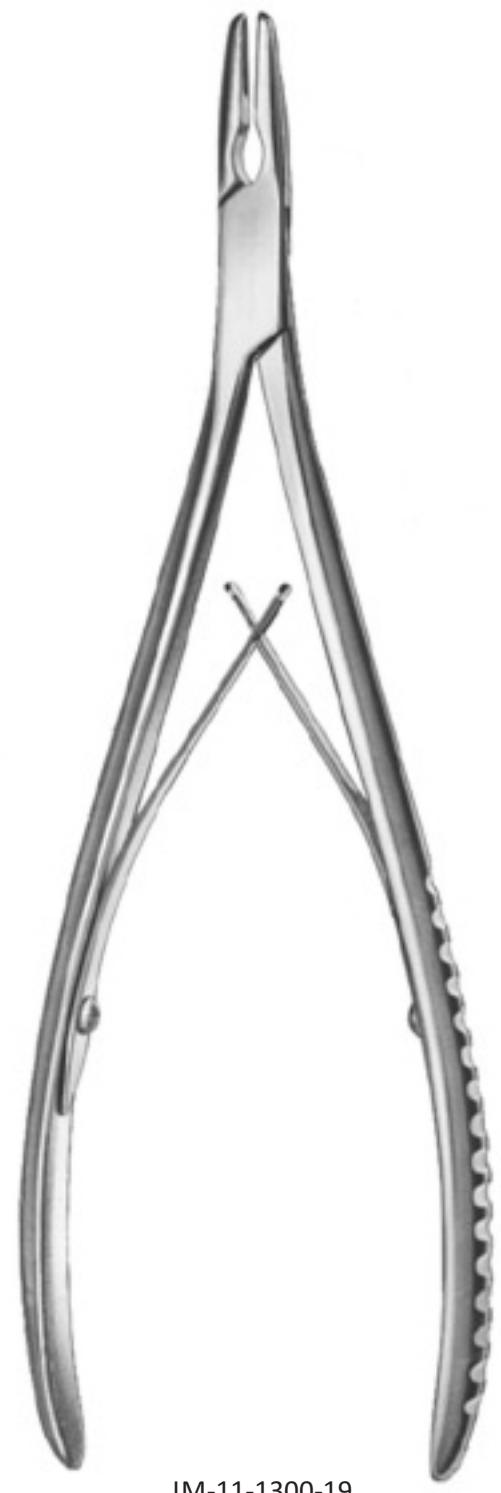

IM-11-1300-19
Lempert
19cm 7 1/2"
Bone Rongeur

Bone Surgery



IM-11-1305-15
Blumenthal
15cm 6"
Bone Rongeur



IM-11-1306-15
Blumenthal
15cm 6"
Bone Rongeur



IM-11-1307-15
Blumenthal
14cm 5 1/2"
Bone Rongeur

Bone Surgery



IM-11-1310-17
Luer
18.5cm 7 1/4"
Bone Rongeur



IM-11-1311-17
Luer
18cm 7"
Bone Rongeur

Bone Surgery



IM-11-1315-15
Luer
14.5cm 5 3/4"
Bone Rongeur



IM-11-1316-15
Luer
14.5cm 5 3/4"
Bone Rongeur



IM-11-1317-15
Luer
14.5cm 5 3/4"
Bone Rongeur

Bone Surgery



IM+1320-15
Böhler
15.5cm 6"
Bone Rongeur



IM91322-15
Böhler
15.5cm 6"
Bone Rongeur

Bone Surgery



IM-11-1325-18
Beyer
18cm 7"
Bone Rongeur



IM-11-1327-18
Zaufal-Jansen
18cm 7"
Bone Rongeur

Bone Surgery



IM-11-1330-17
Mayfield
18cm 7"
Bone Rongeur



IM-11-1332-20
Marquard
20.5cm 8"
Bone Rongeur

Bone Surgery



IM-11-1335-18
Ruskin
19cm 7 1/2"
Bone Rongeur



IM-11-1335-23
Ruskin
24cm 9 1/2"
Bone Rongeur



IM-11-1340-22
Semb
23.5cm 9 1/4"
Bone Rongeur

Bone Surgery



IM-11-1345-23
Stille
22.5cm 8 3/4"
Bone Rongeur



IM-11-1350-02
Echlin
23cm 9"
Bone Rongeur



IM-11-1350-03
Echlin
23cm 9"
Bone Rongeur



IM-11-1350-04
Echlin
23cm 9"
Bone Rongeur

Bone Surgery



IM-11-1355-23
Stille-Ruskin
23.5cm 9 1/4"
Bone Rongeur



IM-11-1360-24
Leksell-Stille
24.5cm 9 3/4"
Bone Rongeur



IM-11-1365-24
Leksell-Stille
24.5cm 9 3/4"
Bone Rongeur

Bone Surgery



IM-11-1370-24
Frykholm
24.5cm 9 3/4"
Bone Rongeur



IM-11-1375-22
Stille-Luer
22.5cm 8 3/4"
Bone Rongeur



IM-11-1377-22
Stille-Luer
22cm 8 3/4"
Bone Rongeur

Bone Surgery



IM-11-1380-23
Stille-Luer
23cm 9"
Bone Rongeur



IM-11-1381-27
Stille-Luer
26.5cm 10 1/2"
Bone Rongeur



IM-11-1382-22
Stille-Luer
23cm 9"
Bone Rongeur



IM-11-1383-22
Stille-Luer
26.5cm 10 1/2"
Bone Rongeur

Bone Surgery



IM-11-1385-30
Sauerbruch
31cm 12 1/4"
Bone Rongeur



IM-11-1386-30
Sauerbruch
31cm 12 1/4"
Bone Rongeur

Bone Surgery



IM-11-1390-20
Markwalder
18.5cm 7 1/4"
Bone Nipper



IM-11-1395-19
Cottle-Kazanjan
18.5cm 7 1/4"
Bone Cutting Forceps

Bone Surgery



IM-11-1400-14
Liston
14cm 5 1/2"
Bone Cutting
Forceps



IM-11-1400-17
Liston
17cm 6 3/4"
Bone Cutting
Forceps



IM-11-1400-19
Liston
20cm 8"
Bone Cutting
Forceps



IM-11-1400-22
Liston
22cm 8 3/4"
Bone Cutting
Forceps

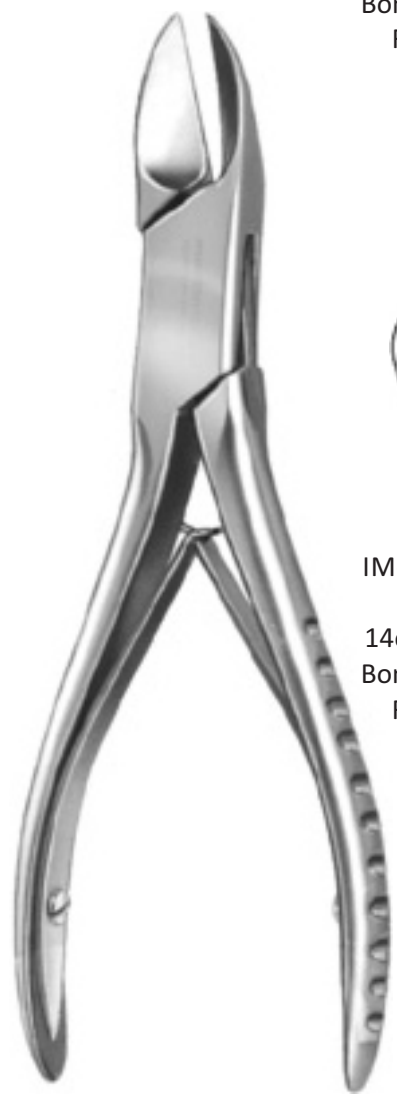

IM-11-1405-14
Liston
14cm 5 1/2"
Bone Cutting
Forceps



IM-11-1405-17
Liston
17cm 6 3/4"
Bone Cutting
Forceps



IM-11-1405-19
Liston
20cm 8"
Bone Cutting
Forceps



IM-11-1405-22
Liston
22cm 8 3/4"
Bone Cutting
Forceps

Bone Surgery



IM-11-1410-17
Cleveland
17cm 6 3/4"
Bone Cutting Forceps



IM-11-1410-15
Cleveland
14.5cm 5 3/4"
Bone Cutting Forceps

Bone Surgery



IM-11-1415-15
Böhler
14.5cm 5 3/4"
Bone Cutting Forceps

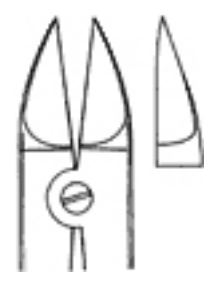

IM-11-1417-15
Böhler
14.5cm 5 3/4"
Bone Cutting Forceps

Bone Surgery



IM-11-1420-16
Cleveland
16cm 6 1/4"
Bone Cutting Forceps



IM-11-1425-18
Ruskin-Liston
18cm 7"
Bone Cutting
Forceps



IM-11-1427-18
Ruskin-Liston
18cm 7"
Bone Cutting
Forceps

Bone Surgery



IM-11-1430-27
Stille-Liston
26cm 10 1/4"
Bone Cutting Forceps

Bone Surgery



IM-11-1435-27
Stille-Liston
27.5cm 10 3/4"
Bone Cutting Forceps



IM-11-1437-23
Stille-Liston
23.5cm 9 1/4"
Bone Cutting Forceps



IM-11-1437-27
Stille-Liston
27.5cm 10 3/4"
Bone Cutting Forceps

Bone Surgery



IM-11-1440-27
Liston-Key
25.5cm 10"
Bone Cutting Forceps



IM-11-1445-24
Semb
24.5cm 9 3/4"
Bone Cutting Forceps

Bone Surgery

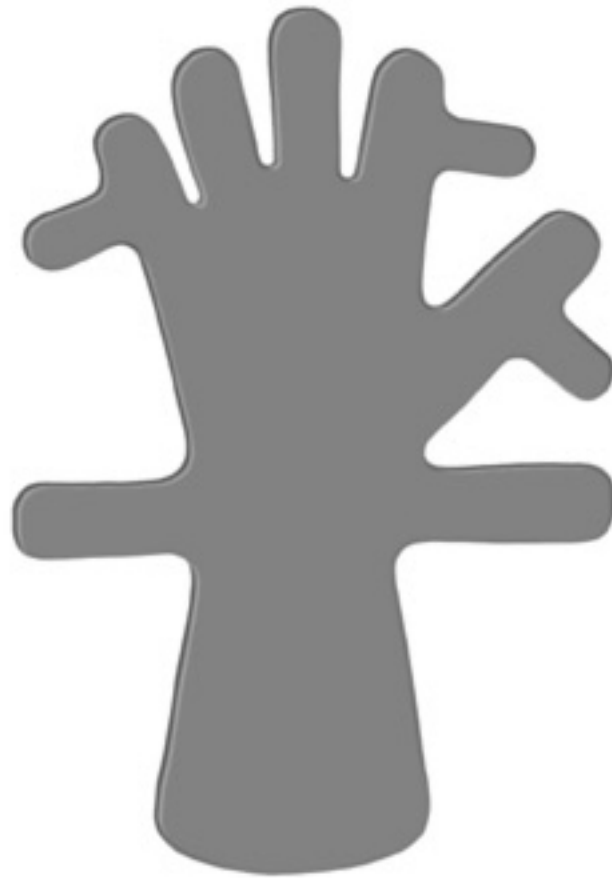

IM-11-1450-01 IM-11-1450-02
Lead Hand for children Lead Hand for adults

Bone Surgery



IM-11-1455-10
Feldheim
104
Tourniquet



IM-11-1460-10
Martin-Ideal
Finger Nail Drillcomplete with 3 drills

Bone Surgery



IM-11-1460-17
Martin
18.5cm 6 3/4"
Finger Ring Saw

Bone Surgery



IM-11-1465-16
Penner
16cm 6 1/4"
Nail Extracting Forceps

IM-11-1470-00
17cm 6 3/4"
Finger Ring Saw

IM-11-1470-01
Saw Blade

Bone Surgery



IM-11-1475-13
Radolf
14cm 5 1/2"
Nail Extracting Forceps

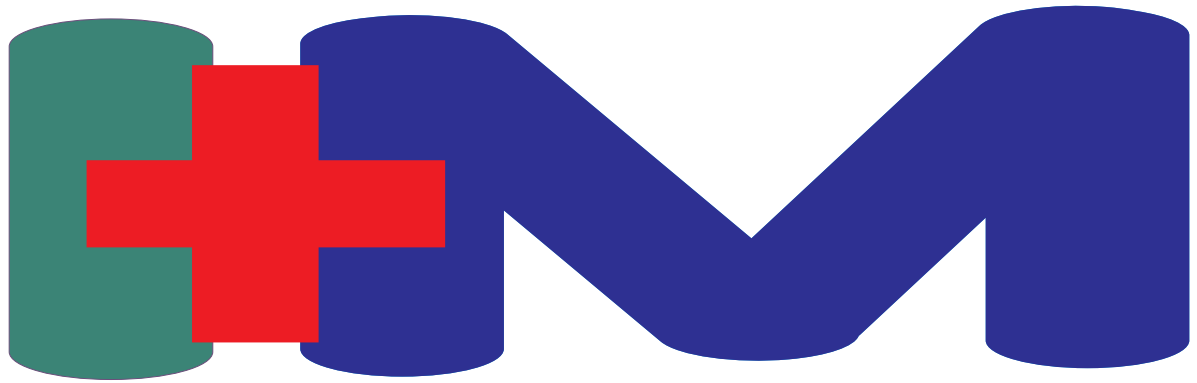

IBRAHIM MEDS

I N S T R U M E N T S

 77 A Model Town Ugoki Sialkot

 +92 52 3512235

 +92 52 4007564

 +92 300 7163508 , +92 307 6427547

 info@ibrahimmeds.com

 amjad@ibrahimmeds.com

 www.ibrahimmeds.com