

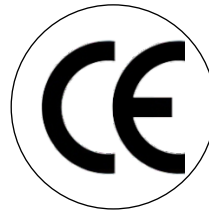

WE SERVE HUMANITY WITH EXCELLENCE

IBRAHIM MEDS



17- GYNECOLOGY

Gynecology



IM-17-200-01
Cusco
Vaginal Speculum
75 x 32 mm



IM-17-200-02
Cusco
Vaginal Speculum
85 x 35 mm



IM-17-200-03
Cusco
Vaginal Speculum
100 x 35 mm



IM-17-202-01
Cusco
Vaginal Speculum
75 x 18 mm



IM-17-205-01
Cusco
Vaginal Speculum
80 x 22 mm



IM-17-205-02
Cusco
Vaginal Speculum
100 x 25 mm

IM-17-205-03
Cusco
Vaginal Speculum
105 x 27 mm



IM-17-210-01
Cusco
Vaginal Speculum
75 x 34 mm



IM-17-210-02
Cusco
Vaginal Speculum
85 x 37 mm

IM-17-210-03
Cusco
Vaginal Speculum
100 x 37 mm

Gynecology

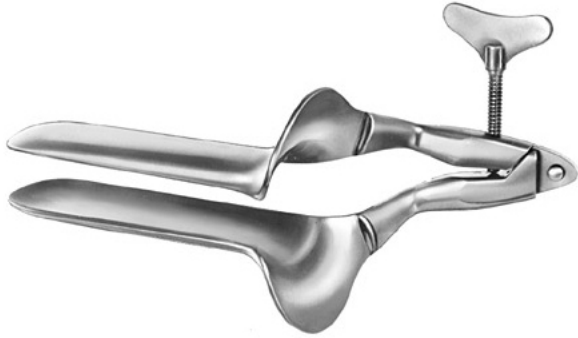

IM-17-220-01
Collin Vaginal Speculum
85 x 30 mm
IM-17-220-02
Collin Vaginal Speculum
100 x 35 mm
IM-17-220-03
Collin Vaginal Speculum
110 x 40 mm



IM-17-225-01
Pederson Vaginal Speculum
75 x 13 mm
IM-17-225-02
Pederson Vaginal Speculum
100 x 22 mm
IM-17-225-03
Pederson Vaginal Speculum
120 x 25 mm



IM-17-230-01
Grave Vaginal Speculum
75 x 20 mm
IM-17-230-02
Grave Vaginal Speculum
95 x 35 mm
IM-17-230-03
Grave Vaginal Speculum
115 x 35 mm



IM-17-235-01
Semm Vaginal Speculum
100 x 20 – 25 mm
IM-177-235-02
Semm Vaginal Speculum
105 x 27 - 35 mm

Gynecology



IM-17-240-01
Sims Vaginal Speculum
65 x 25 mm / 70 x 30 mm
IM-17-240-02
Sims Vaginal Speculum
70 x 30 mm / 70 x 35 mm
IM-17-240-03
Sims Vaginal Speculum
85 x 35 mm / 90 x 40 mm



IM-17-245-01
Kristeller Vaginal Speculum
Fig. 1 70 x 27 mm
IM-17-245-02
Kristeller Vaginal Speculum
Fig. 280 x 30 mm
IM-17-245-03
Kristeller Vaginal Speculum
Fig. 390 x 36 mm



IM-17-250-01
Kristeller Vaginal Retractor
Fig. 1 75 x 23 mm
IM-17-250-02
Kristeller Vaginal Retractor
Fig. 285 x 26 mm
IM-17-250-03
Kristeller Vaginal Retractor
Fig. 3100 x 32 mm



IM-17-255-01
Kristeller Vaginal Speculumset no.
1 consisting of 17-256-01 + 17-257-01
IM-17-255-02
Kristeller Vaginal Speculumset no.
2 consisting of 17-258-02 + 17-259-02
IM-17-255-03
Kristeller Vaginal Speculumset no.
3 consisting of 17-260-03 + 17-261-03

Gynecology



IM-17-265-01
Kristeller
Vaginal Speculum
Fig. 1105 x 18 mm
slender pattern
PM-17-265-02
Kristeller
Vaginal Speculum
Fig. 2105 x 21 mm
slender pattern



IM-17-270-01
Kristeller
Vaginal Retractor
Fig. 1110 x 14 mm
slender pattern
IM-17-270-02
2Kristeller
Vaginal Retractor
Fig. 2110 x 17 mm
slender pattern



IM-17-275-01
Kristeller
Vaginal Speculum
set no. 1consisting of
IM-17-276-01 + IM-17-277-01
slender pattern
IM-17-275-02
Kristeller
Vaginal Speculum
set no. 2consisting of
IM-17-278-02 + IM-17-279-02
slender pattern



IM-17-280-01
Kristeller
Vaginal Speculum
Fig. 1 105 x 26 mm
flat speculum
IM-17-280-02
Kristeller
Vaginal Speculum
Fig. 2105 x 28 mm
flat speculum
IM-17-280-03
Kristeller
Vaginal Speculum
Fig. 3105 x 33 mm
flat speculum

Gynecology

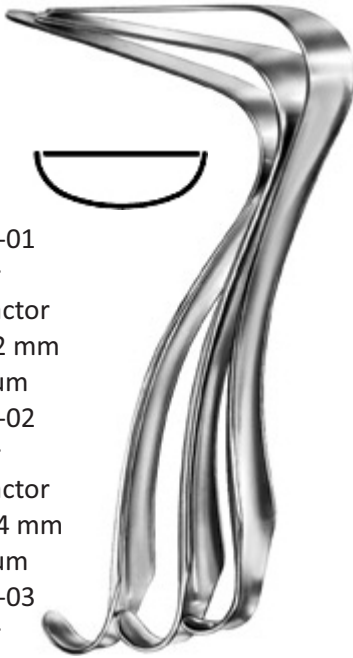

IM-17-285-01
Kristeller
Vaginal Retractor
Fig. 1 115 x 22 mm
flat speculum
IM-17-285-02
Kristeller
Vaginal Retractor
Fig. 2 115 x 24 mm
flat speculum
IM-17-285-03
Kristeller
Vaginal Retractor
Fig. 3 115 x 29 mm
flat speculum



IM-17-290-01
Kristeller
Vaginal Speculum
set no. 1 consisting of
IM-17-291-01 + IM-17-292-01
flat speculum
IM-17-290-02
Kristeller
Vaginal Speculum
set no. 2 consisting of
IM-17-293-02 + IM-17-294-02
flat speculum
IM-17-290-03
Kristeller
Vaginal Speculum
set no. 3 consisting of
IM-17-295-03 + IM-17-296-03
flat speculum

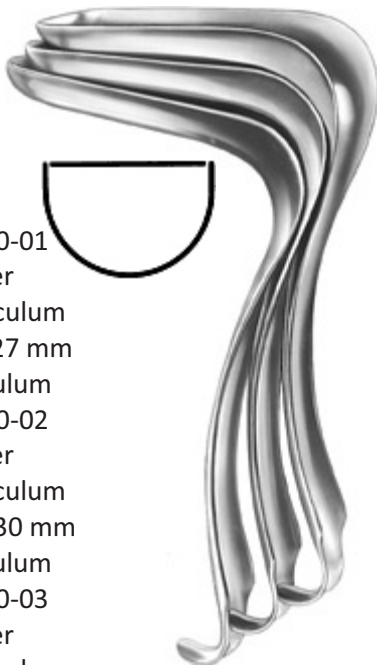

IM-17-300-01
Kristeller
Vaginal Speculum
Fig. 1 110 x 27 mm
deep speculum
IM-17-300-02
Kristeller
Vaginal Speculum
Fig. 2 110 x 30 mm
deep speculum
IM-17-300-03
Kristeller
Vaginal Speculum
Fig. 3 110 x 36 mm
deep speculum

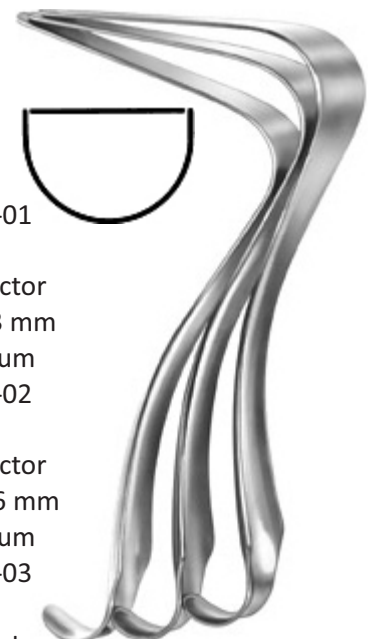

IM-17-305-01
Kristeller
Vaginal Retractor
Fig. 1 115 x 23 mm
deep speculum
IM-17-305-02
Kristeller
Vaginal Retractor
Fig. 2 115 x 26 mm
deep speculum
IM-17-305-03
Kristeller
Vaginal Retractor
Fig. 3 115 x 32 mm
deep speculum

Gynecology

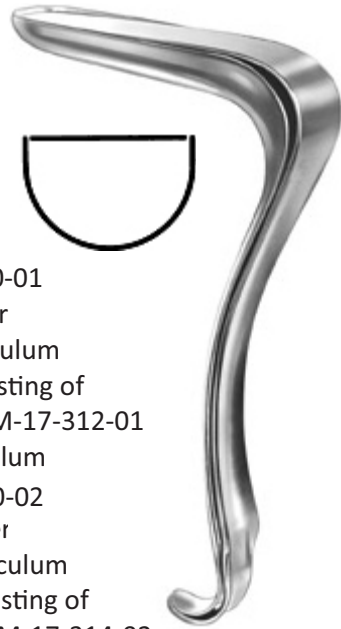

IM-17-310-01
Kristeller
Vaginal Speculum
set no. 1 consisting of
IM-17-311-01 + IM-17-312-01
deep speculum
IM-17-310-02
Kristeller
Vaginal Speculum
set no. 2 consisting of
IM-17-313-02 + IM-17-314-02
deep speculum
IM-17-310-03
Kristeller
Vaginal Speculum
set no. 3 consisting of
IM-17-315-03 + IM-17-316-03
deep speculum

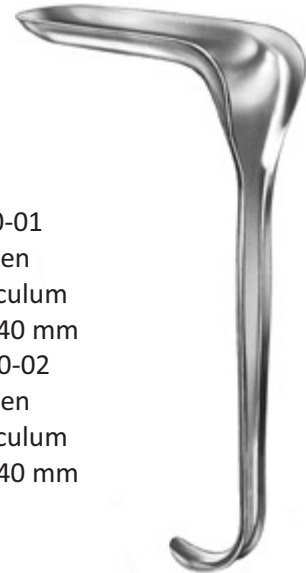

M-17-320-01
Kallmorgen
Vaginal Speculum
Fig.1 170 x 40 mm
IM-17-320-02
Kallmorgen
Vaginal Speculum
Fig.2 290 x 40 mm

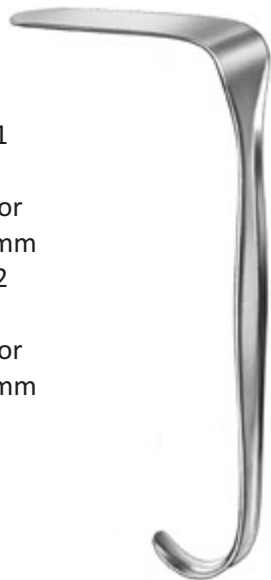

IM-17-325-01
Kallmorgen
Vaginal Retractor
Fig.1 170 x 33 mm
IM-17-325-02
Kallmorgen
Vaginal Retractor
Fig.2 290 x 33 mm

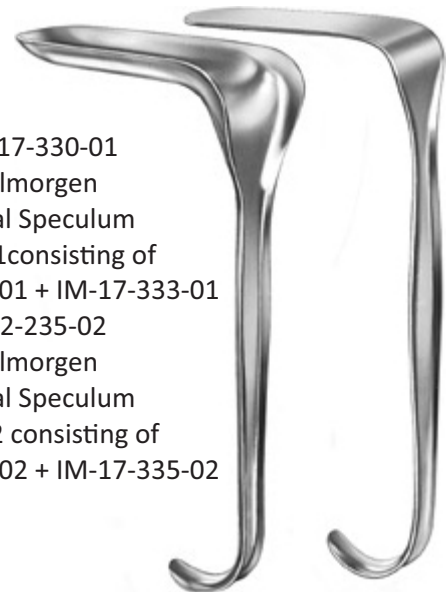

IM-17-330-01
Kallmorgen
Vaginal Speculum
set no. 1 consisting of
IM-17-332-01 + IM-17-333-01
ZI-32-235-02
Kallmorgen
Vaginal Speculum
set no. 2 consisting of
IM-17-334-02 + IM-17-335-02

Gynecology

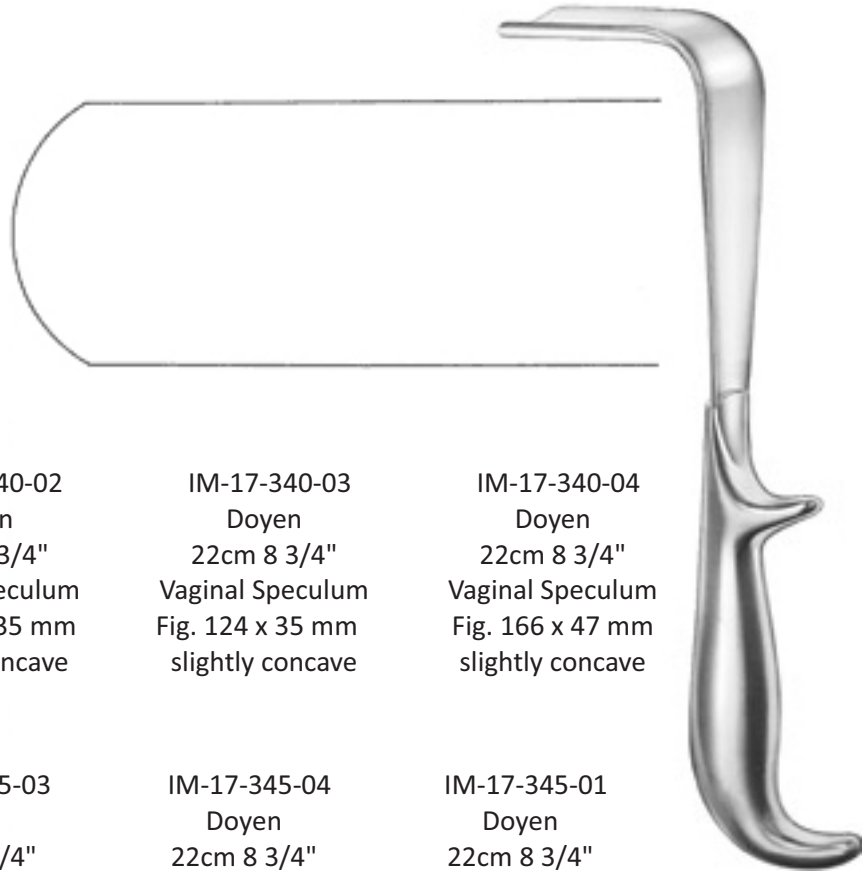

IM-17-340-01
Doyen
22cm 8 3/4"
Vaginal Speculum
Fig. 163 x 35 mm
slightly concave

IM-17-340-02
Doyen
22cm 8 3/4"
Vaginal Speculum
Fig. 294 x 35 mm
slightly concave

IM-17-340-03
Doyen
22cm 8 3/4"
Vaginal Speculum
Fig. 124 x 35 mm
slightly concave

IM-17-340-04
Doyen
22cm 8 3/4"
Vaginal Speculum
Fig. 166 x 47 mm
slightly concave

IM-17-345-02
Doyen
22cm 8 3/4"
Vaginal Speculum
Fig. 295 x 47 mm
slightly concave

IM-17-345-03
Doyen
22cm 8 3/4"
Vaginal Speculum
Fig. 126 x 47 mm
slightly concave

IM-17-345-04
Doyen
22cm 8 3/4"
Vaginal Speculum
Fig. 160 x 47 mm
slightly concave

IM-17-345-01
Doyen
22cm 8 3/4"
Vaginal Speculum
Fig. 155 x 60 mm
slightly concave

IM-17-350-02
Doyen
22cm 8 3/4"
Vaginal Speculum
Fig. 295 x 60 mm
slightly concave

IM-17-350-03
Doyen
22cm 8 3/4"
Vaginal Speculum
Fig. 130 x 60 mm
slightly concave

IM-17-350-04
Doyen
22cm 8 3/4"
Vaginal Speculum
Fig. 4 175 x 60 mm
slightly concave

Gynecology



IM-17-355-00
Scherbak
Vaginal Speculum
complete set with handle,
weight (400 g) and 5 blades

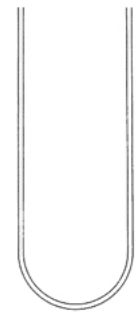

IM-17-355-01
Scherbak
Specula Blade,
only 80 x 30 mm
Specula Blade, only

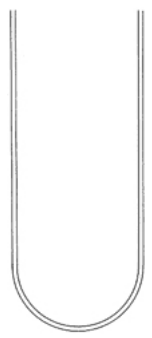

IM-17-355-02
Scherbak
Specula Blade,
only 85 x 35 mm
Specula Blade, only



IM-17-355-03
Scherbak
Specula Blade,
only 90 x 40 mm
Specula Blade, only

Gynecology



IM-17-355-04
Scherbak
Specula Blade,
only 62 x 40 - 60 mm
Specula Blade, only



IM-17-355-05
Scherbak
Specula Blade,
only 81 x 45 - 70 mm
Specula Blade, only



IM-17-355-10
Scherbak
10.5
Weight for Vaginal Speculum
400 g Weight for Vaginal Speculum
ZI-32-302-12
Scherbak
13cm 5"
Weight for Vaginal Speculum
800 g Weight for Vaginal Speculum



IM-17-355-14
Scherbak
20cm 8"
Handle for Vaginal Speculum
Handle for Vaginal Speculum

Gynecology

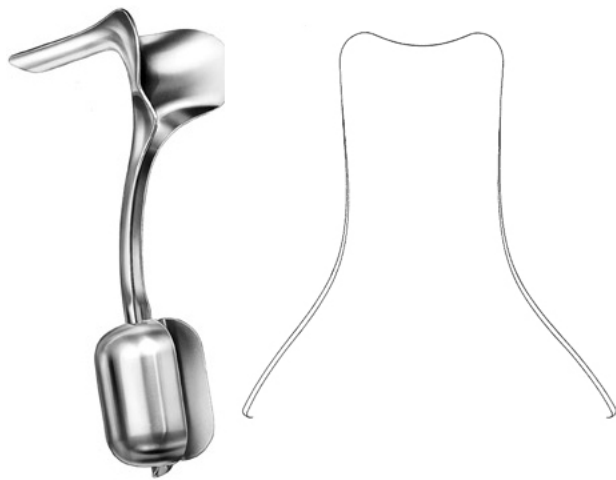

IM-17-360-22
Auvard
23.5cm 9 1/4"
Vaginal Speculum
80 x 43 mm
complete,
with detachable weight



IM-17-360-24
Weissbarth
21cm 8 1/4"
Vaginal Speculum
80 x 42 mm
complete,
with detachable strainer
IM-17-362-99
Weissbarth
Strainer for Vaginal Speculum
Strainer for Vaginal Speculum

Gynecology

<p>IM-17-365-20 Breisky 29cm 11 1/2" Vaginal Speculum 100 x 20 mm</p>	<p>IM-17-365-25 Breisky 29cm 11 1/2" Vaginal Speculum 100 x 25 mm</p>	<p>IM-17-365-30 Breisky 29cm 11 1/2" Vaginal Speculum 100 x 30 mm</p>	<p>IM-17-365-35 Breisky 29cm 11 1/2" Vaginal Speculum 100 x 35 mm</p>
<p>IM-17-365-40 Breisky 29cm 11 1/2" Vaginal Speculum 100 x 40 mm</p>	<p>IM-117-366-20 Breisky 32cm 12 1/2" Vaginal Speculum 130 x 20 mm</p>	<p>IM-17-366-25 Breisky 32cm 12 1/2" Vaginal Speculum 130 x 25 mm</p>	<p>IM-17-366-30 Breisky 32cm 12 1/2" Vaginal Speculum 130 x 30 mm</p>
<p>IM-17-367-35 Breisky 32cm 12 1/2" Vaginal Speculum 130 x 35 mm</p>	<p>IM-17-367-40 Breisky 32cm 12 1/2" Vaginal Speculum 130 x 40 mm</p>	<p>IM-17-367-40 Breisky 34.5cm 13 1/2" Vaginal Speculum 155 x 40 mm</p>	

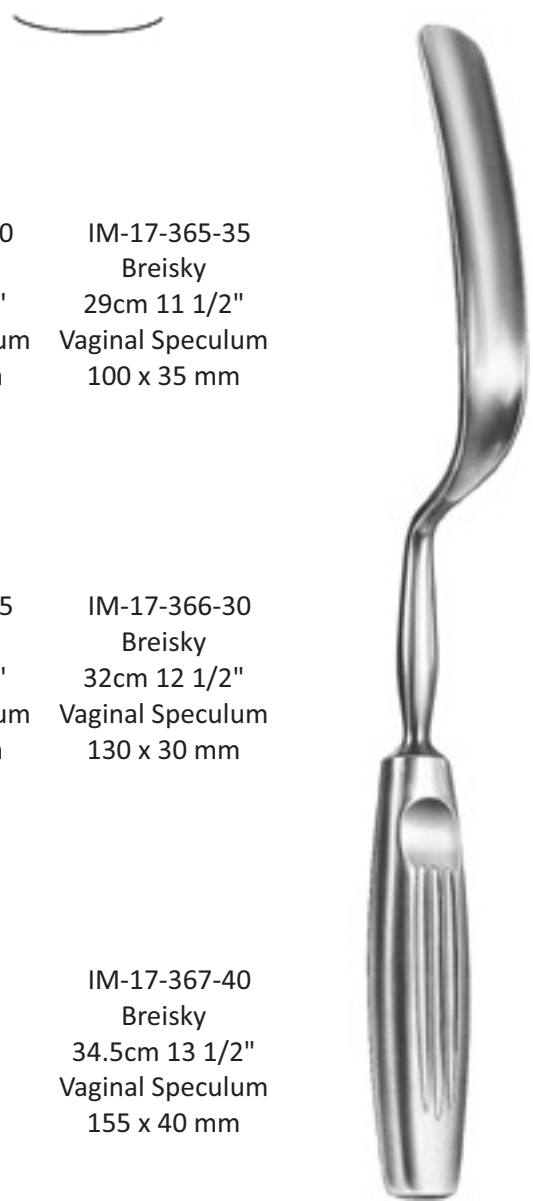

Gynecology



IM-317-70-24
Doyen
25cm 9 3/4"
Vaginal Retractor
70 x 30 mm



IM-17-375-24
Kogan
24.5cm 9 3/4"
Endocervical Speculum



IM-17-380-24
Kogan
24.5cm 9 3/4"
Endocervical Speculum
with graduated ratchet
and fixing screw



- IM-17-385-01 Hegar 18.5cm 7 1/4" Uterine Dilator 1,0
- IM-17-385-02 Hegar 18.5cm 7 1/4" Uterine Dilator 2,0
- IM-17-385-03 Hegar 18.5cm 7 1/4" Uterine Dilator 3,0
- IM-17-385-04 Hegar 18.5cm 7 1/4" Uterine Dilator 4,0
- IM-17-385-05 Hegar 18.5cm 7 1/4" Uterine Dilator 5,0
- IM-17-385-06 Hegar 18.5cm 7 1/4" Uterine Dilator 6,0
- IM-17-385-07 Hegar 18.5cm 7 1/4" Uterine Dilator 7,0
- IM-17-385-08 Hegar 18.5cm 7 1/4" Uterine Dilator 8,0
- IM-17-385-09 Hegar 18.5cm 7 1/4" Uterine Dilator 9,0
- IM-17-385-10 Hegar 18.5cm 7 1/4" Uterine Dilator 10,0
- IM-17-385-11 Hegar 18.5cm 7 1/4" Uterine Dilator 11,0
- IM-17-385-12 Hegar 18.5cm 7 1/4" Uterine Dilator 12,0
- IM-17-385-13 Hegar 18.5cm 7 1/4" Uterine Dilator 13,0
- IM-17-385-14 Hegar 18.5cm 7 1/4" Uterine Dilator 14,0
- IM-17-385-15 Hegar 18.5cm 7 1/4" Uterine Dilator 15,0
- IM-17-385-16 Hegar 18.5cm 7 1/4" Uterine Dilator 16,0
- IM-17-385-17 Hegar 18.5cm 7 1/4" Uterine Dilator 17,0
- IM-17-385-18 Hegar 18.5cm 7 1/4" Uterine Dilator 18,0
- IM-17-385-19 Hegar 18.5cm 7 1/4" Uterine Dilator 19,0
- IM-17-385-20 Hegar 18.5cm 7 1/4" Uterine Dilator 20,0
- IM-17-385-21 Hegar 18.5cm 7 1/4" Uterine Dilator 21,0
- IM-17-385-22 Hegar 18.5cm 7 1/4" Uterine Dilator 22,0
- IM-17-385-23 Hegar 18.5cm 7 1/4" Uterine Dilator 23,0
- IM-17-385-24 Hegar 18.5cm 7 1/4" Uterine Dilator 24,0
- IM-17-385-25 Hegar 18.5cm 7 1/4" Uterine Dilator 25,0
- IM-17-385-26 Hegar 18.5cm 7 1/4" Uterine Dilator 26,0



IM-17-390-80

Hegar

Uterine Dilators, Set
set of 14 pieces (full sizes)
from 4,0 to 17,0 mm without case

IM-17-392-84

Hegar

Uterine Dilators, Set
set of 14 pieces (full sizes)
from 4,0 to 17,0 mm in metal case

IM-17-392-90

Hegar

Uterine Dilators, Set
set of 26 pieces (full sizes)
from 1,0 to 26,0 mm without case



- IM-17-395-01 Hegar18.5cm 7 1/4" Uterine Dilator 1,5
- IM-17-395-02 Hegar18.5cm 7 1/4" Uterine Dilator 2,5
- IM-17-395-03 Hegar18.5cm 7 1/4" Uterine Dilator 3,5
- IM-17-395-04 Hegar18.5cm 7 1/4" Uterine Dilator 4,5
- IM-17-395-05 Hegar18.5cm 7 1/4" Uterine Dilator 5,5
- IM-17-395-06 Hegar18.5cm 7 1/4" Uterine Dilator 6,5
- IM-17-395-07 Hegar18.5cm 7 1/4" Uterine Dilator 7,5
- IM-17-395-08 Hegar18.5cm 7 1/4" Uterine Dilator 8,5
- IM-17-395-09 Hegar18.5cm 7 1/4" Uterine Dilator 9,5
- IM-17-395-10 Hegar18.5cm 7 1/4" Uterine Dilator 10,5
- IM-17-395-11 Hegar18.5cm 7 1/4" Uterine Dilator 11,5
- IM-17-395-12 Hegar18.5cm 7 1/4" Uterine Dilator 12,5
- IM-17-395-13 Hegar18.5cm 7 1/4" Uterine Dilator 13,5
- IM-17-395-14 Hegar18.5cm 7 1/4" Uterine Dilator 14,5
- IM-17-395-15 Hegar18.5cm 7 1/4" Uterine Dilator 15,5
- IM-17-395-16 Hegar18.5cm 7 1/4" Uterine Dilator 16,5
- IM-17-395-17 Hegar18.5cm 7 1/4" Uterine Dilator 17,5



- IM-17-400-02 Hegar20cm 8" Uterine Dilator 1,0 / 2,0
- IM-17-400-04 Hegar20cm 8" Uterine Dilator 3,0 / 4,0
- IM-17-400-06 Hegar20cm 8" Uterine Dilator 5,0 / 6,0
- IM-17-400-08 Hegar20cm 8" Uterine Dilator 7,0 / 8,0
- IM-17-400-10 Hegar20cm 8" Uterine Dilator 9,0 / 10,0
- IM-17-400-12 Hegar20cm 8" Uterine Dilator 11,0 / 12,0
- IM-17-400-14 Hegar20cm 8" Uterine Dilator 13,0 / 14,0
- IM-17-400-16 Hegar20cm 8" Uterine Dilator 15,0 / 16,0
- IM-17-400-18 Hegar20cm 8" Uterine Dilator 17,0 / 18,0
- IM-17-400-20 Hegar20cm 8" Uterine Dilator 19,0 / 20,0
- IM-17-400-22 Hegar20cm 8" Uterine Dilator 21,0 / 22,0
- IM-17-400-24 Hegar20cm 8" Uterine Dilator 23,0 / 24,0
- IM-17-400-26 Hegar20cm 8" Uterine Dilator 25,0 / 26,0

Gynecology

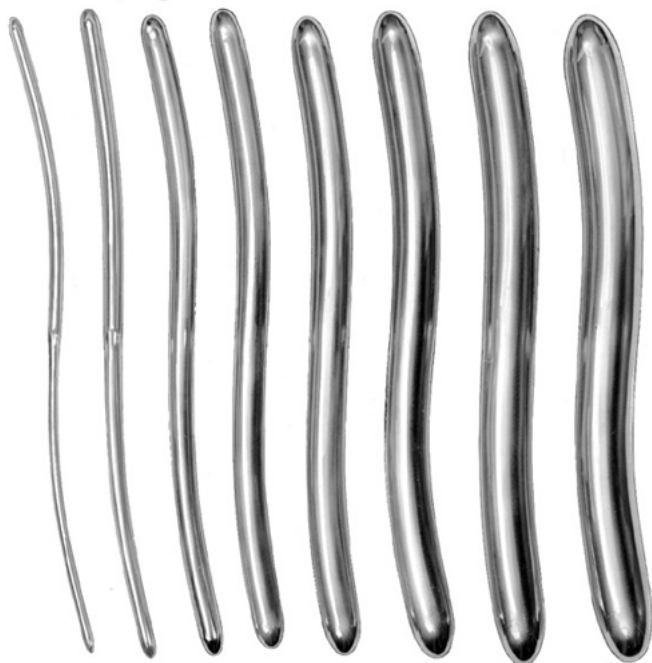

IM-17-400-80
Hegar
Uterine Dilators,
Setset of 8 pieces from
3,0 / 4,0 to 17,0 / 18,0 mm
without case



IM-17-400-82
Hegar
Uterine Dilators,
Setset of 8 pieces from
3,0 / 4,0 to 17,0 / 18,0 mm
in boilable canvas roll

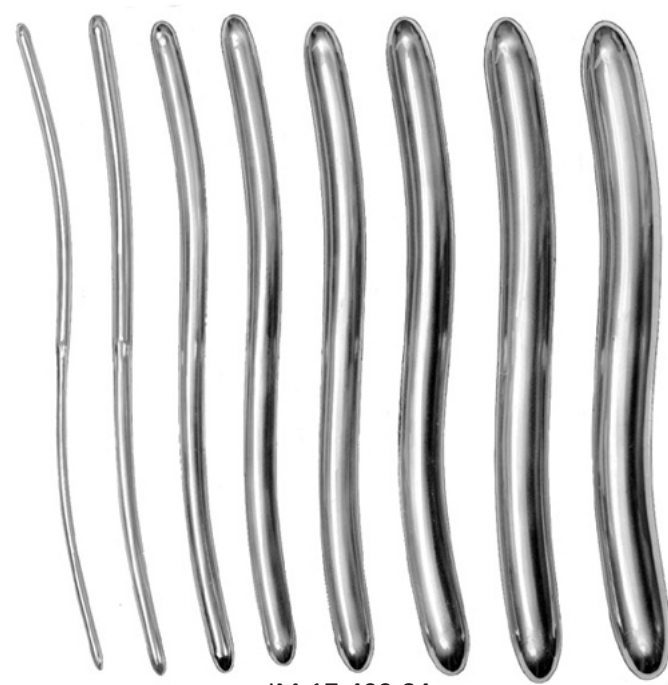

IM-17-400-84
Hegar Uterine Dilators,
Setset of 8 pieces from 3,0 / 4,0 to 17,0 / 18,0 mm in metal case with hinged lid

Gynecology



IM-17-405-10 Hank 26.5cm 10 1/2" Uterine Dilator Fig. 9/104, 5 / 5,0 mm Ø American scale	IM-17-405-12 Hank 26.5cm 10 1/2" Uterine Dilator Fig. 11/125, 5 / 6,0 mm Ø American scale	IM-17-405-14 Hank 26.5cm 10 1/2" Uterine Dilator Fig. 13/146, 5 / 7,0 mm Ø American scale	IM-17-405-16 Hank 26.5cm 10 1/2" Uterine Dilator Fig. 15/167, 5 / 8,0 mm Ø American scale	IM-17-405-18 Hank 26.5cm 10 1/2" Uterine Dilator Fig. 17/188, 5 / 9,0 mm Ø American scale	IM-17-405-20 Hank 26.5cm 10 1/2" Uterine Dilator Fig. 19/209, 5 / 10,0 mm Ø American scale
--	---	---	---	---	--



IM-17-405-82
Hank
Uterine Dilators,
Setset of 6 piezasin boilable
canvas roll

Gynecology



IM-17-410-32
Sims
33cm 13"
Uterine Sound rigid



IM-17-412-32
Sims
33cm 13"
Uterine Sound
malleable



IM-17-415-25
Valleix
29.5cm 11 1/2"
Uterine Sound

Gynecology



IM-17-420-26
Braun
27.5cm 10 3/4"
Uterine Depressor



IM-17-425-25
Schröder
25.5cm 10"
Uterine Tenaculum Forceps



IM-417-428-25
Braun
26cm 10 1/4"
Uterine Tenaculum Forceps

Gynecology



IM-17-430-28
Duplay
25.5cm 10"
Uterine Tenaculum Forceps



IM-17-435-26
Beacham
26cm 10 1/4"
Amniotome
Amniotome



IM-17-440-24
Skene
24cm 9 1/2"
Uterine Tenaculum Forceps

Gynecology



IM-17-445-24
Schröder
25cm 9 3/4"
Uterine Tenaculum Forceps



IM-17-450-24
Schröder
23.5cm 9 1/4"
Uterine Tenaculum Forceps

Gynecology



IM-17-455-23
Teale
23.5cm 9 1/4"
Uterine Tenaculum Forceps
3:4 teeth

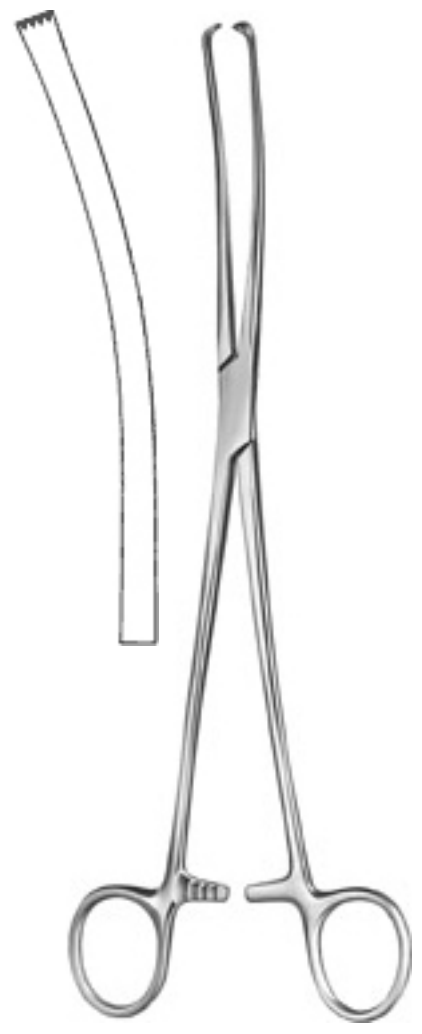

IM-17-460-26
Iowa
26cm 10 1/4"
Uterine Tenaculum Forceps

Gynecology



IM-17-465-24
Museux
24cm 9 1/2"
Uterine Tenaculum
Forceps
2:2 teeth6 mm



IM-17-467-24
Museux
24cm 9 1/2"
Uterine Tenaculum
Forceps
2:2 teeth8 mm



IM-17-469-24
Museux
24cm 9 1/2"
Uterine Tenaculum
Forceps
2:2 teeth10 mm



IM-17-470-21
Jacobs
21cm 8 1/4"
Uterine Tenaculum
Forceps
2:2 teeth

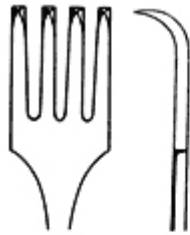

IM-17-475-26
26.5cm 10 1/2"
Uterine Tenaculum
Forceps



IM-17-480-16
Braun
16cm 6 1/4"
Uterine Tenaculum
Forceps

Gynecology



IM-17-485-21
Czerny
21cm 8 1/4"
Uterine Tenaculum
Forceps

IM-17-490-32
Kelly
32cm 12 1/2"
Uterine Polypus
Forceps

IM-17-495-27
Noto
27cm 10 3/4"
Uterine Polypus
Forceps

Gynecology

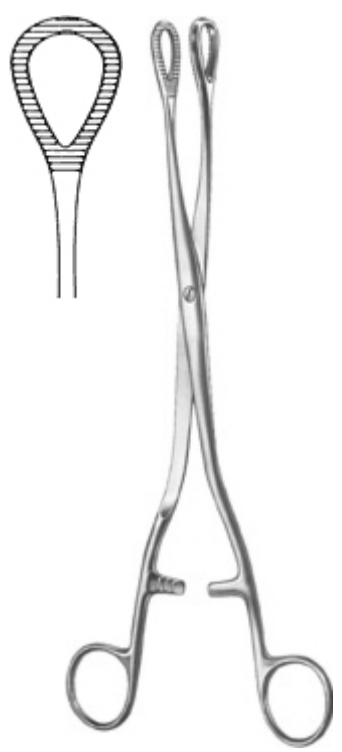

IM-17-500-25
Heywood-Smith
25cm 9 3/4"
Uterine Polypus
Forceps



IM-17-505-17
Doyen
17cm 6 3/4"
Myoma Screw
spiral 14 mm Ø



IM-17-507-17
Doyen
14.5cm 5 3/4"
Myoma Screw
spiral 25 mm Ø

Gynecology

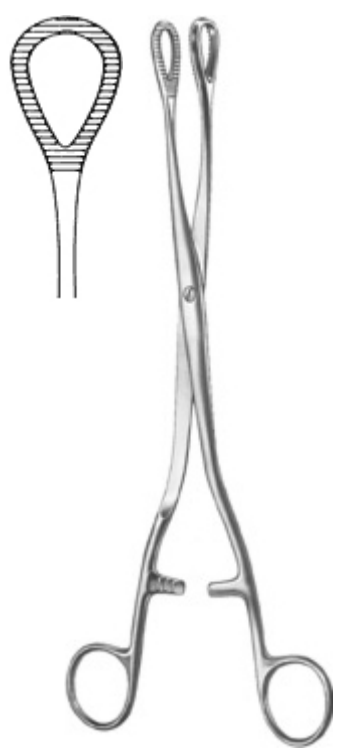

IM-17-500-25
Heywood-Smith
25cm 9 3/4"
Uterine Polypus
Forceps



IM-17-505-17
Doyen
17cm 6 3/4"
Myoma Screw
spiral 14 mm Ø



IM-17-507-17
Doyen
14.5cm 5 3/4"
Myoma Screw
spiral 25 mm Ø

Gynecology



IM-17-510-27
Segond
28cm 11"
Myoma Knife
cutting edge
13 mm wide



IM-17-515-27
Dartigues
28cm 11"
Uterine Seizing
Forceps
jaw 32 mm wide

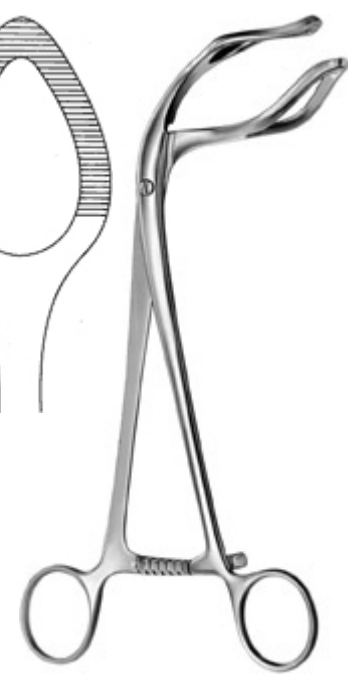
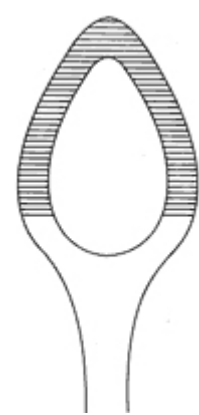

IM-17-520-23
Somer
22.5cm 8 3/4"
Uterine Seizing
Forceps
jaw 32 mm wide

Gynecology



IM-17-525-25
Collin
26cm 10 1/4"
Uterine Seizing Forceps
jaw 40 mm wide

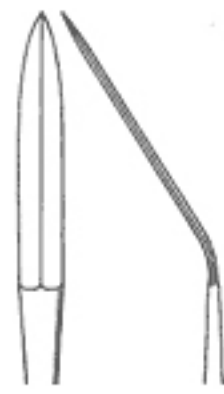

IM-17-530-23
Ayre
23.5cm 9 1/4"
Conization Knife
cutting edge 6,3mm
wide Conization Knife

Gynecology



IM-17-535-03
Emmett
22cm 8 3/4"
Fistula Hook
Fig. 3



IM-17-540-22
Simon
21.5cm 8 1/2"
Fistula Hook



IM-17-540-22
Simon
21.5cm 8 1/2"
Fistula Hook

Gynecology

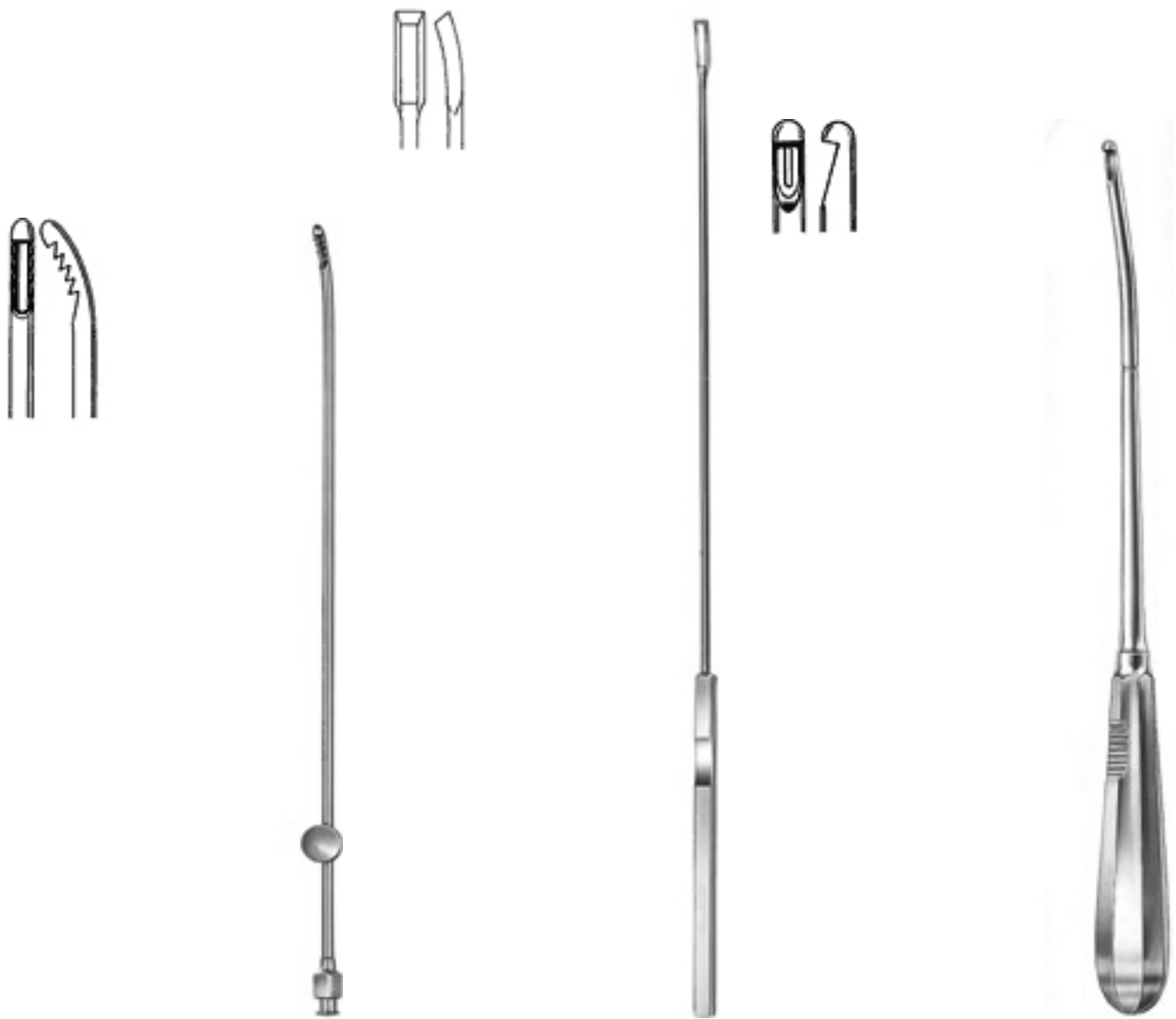

IM-17-545-23
Novak
24.5cm 9 3/4"
Suction Curette
4,0 mm Ø
with Luer-Lock
connection

IM-17-550-30
Kevorkian
30cm 11 3/4"
Uterine Biopsy Curette
6,0 mm Ø

IM-17-555-27
München
27cm 10 3/4"
Uterine Biopsy Curette
4,8 mm Ø

Gynecology



IM-17-560-23
Gellhorn
24cm 9 1/2"
Uterine Biopsy Forceps
jaw 8,6 mm wide



IM-17-565-21
Faure
21cm 8 1/4"
Uterine Biopsy Forceps
jaw 8,4 mm wide



IM-17-570-21
Schubert
21.5cm 8 1/2"
Uterine Biopsy Forceps
jaw 4,8 mm wide

Gynecology



IM-17-575-28
Schubert
28cm 11"
Uterine Biopsy Forceps
jaw 4,8 mm wide



IM-17-580-22	IM-17-582-24
Thoms-Gaylor	Thoms-Gaylor
21cm 8 1/4"	23.5cm 9 1/4"
Uterine Biopsy Forceps	Uterine Biopsy Forceps
jaw 5,6 mm Ø	jaw 5,6 mm Ø

Gynecology

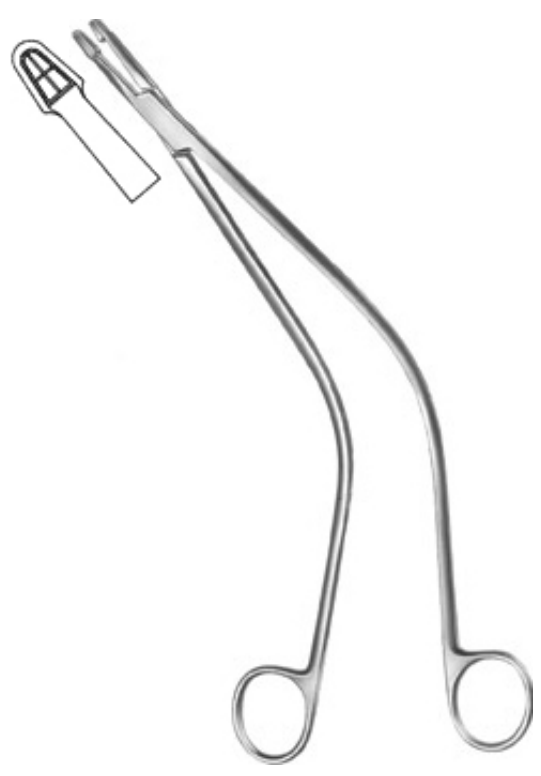

IM-17-585-26
Schubert
25.5cm 10"
Uterine Biopsy Forceps
jaw 5,0 mm wide



IM-17-590-24
Van Doren
27cm 10 3/4"
Uterine Biopsy Forceps
jaw 5,5 mm wide



IM-17-595-25
Van Doren
25.5cm 10"
Uterine Biopsy Forceps
jaw 4,9 mm wide

Gynecology



IM-17-600-28
Alexander
28cm 11"

Uterine Biopsy Forceps
jaw 5,1 mm wide

retrograde cutting, jaws curved to left suitable also in colpos copy



IM-17-605-32
Kevorkian
25cm 9 3/4"

Uterine Biopsy Forceps

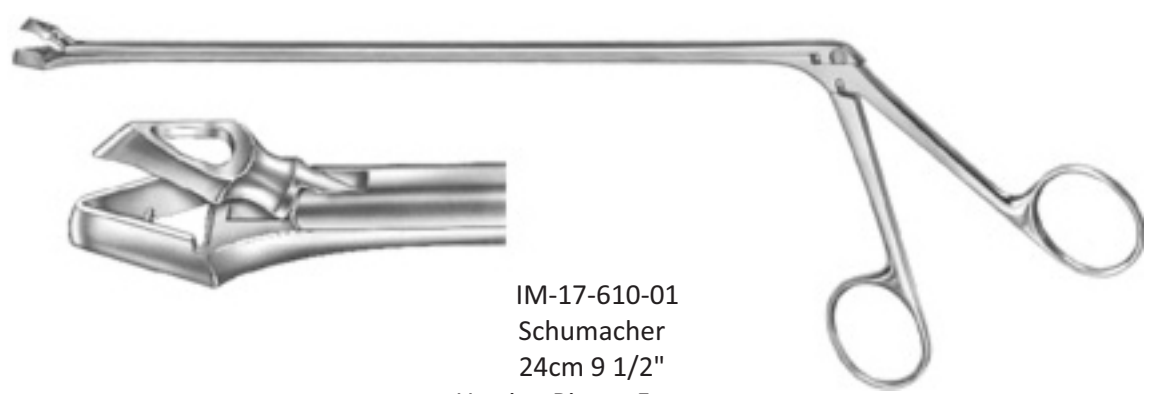

IM-17-610-01
Schumacher
24cm 9 1/2"

Uterine Biopsy Forceps
jaw 4,6 mm wide

IM-17-612-02
Schumacher
24cm 9 1/2"

Uterine Biopsy Forceps
jaw 5,4 mm wide

Gynecology



A

IM-17-615-00
Schumacher
25cm 9 3/4"
Uterine Biopsy Forceps
complete

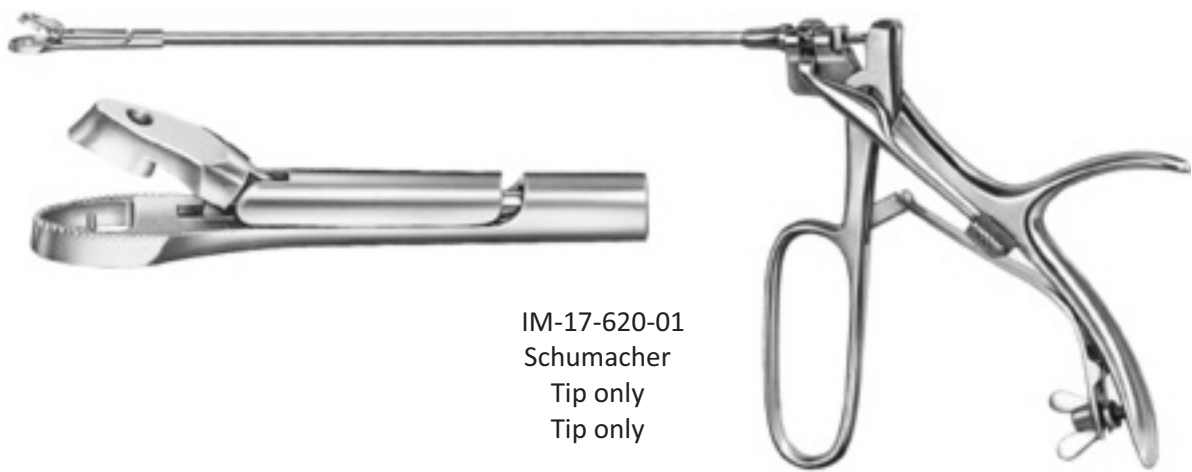

IM-17-620-01
Schumacher
Tip only
Tip only



IM-17-625-22
22cm 8 3/4"
IUP Grasping Forceps
3,0 mm Ø
flexible shaft
for grasping intra
uterine devices

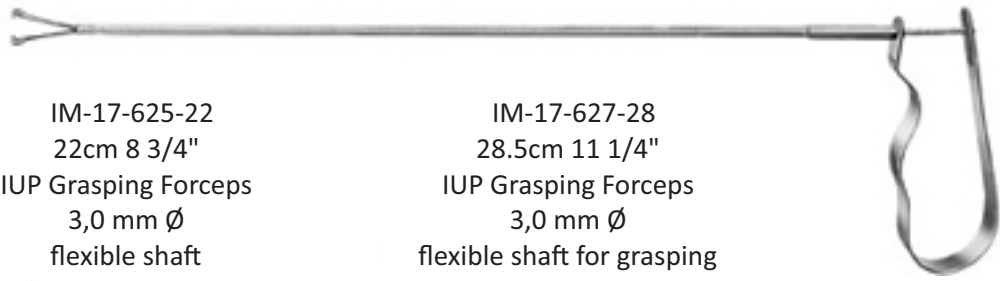

IM-17-627-28
28.5cm 11 1/4"
IUP Grasping Forceps
3,0 mm Ø
flexible shaft for grasping
intra uterine devices

Gynecology



IM-17-630-01
Simon
24.5cm 9 3/4"
Uterine Scoop
9,8 x 6,8 mm
sharp, rigid



IM-17-630-02
Simon
24.5cm 9 3/4"
Uterine Scoop
11,6 x 8,3 mm
sharp, rigid



IM-17-630-03
Simon
24.5cm 9 3/4"
Uterine Scoop
13,2 x 10,0 mm
sharp, rigid



IM-17-630-04
Simon
24.5cm 9 3/4"
Uterine Scoop
16,0 x 11,6 mm
sharp, rigid



IM-17-630-05
Simon
25cm 9 3/4"
Uterine Scoop
18,0 x 12,6 mm
sharp, rigid



IM-17-630-06
Simon
25cm 9 3/4"
Uterine Scoop
20,0 x 13,8 mm
sharp, rigid

Gynecology



IM-17-635-01
Simon
30cm 11 3/4"
Uterine Scoop
9,8 x 6,8 mm
sharp, rigid



IM-17-635-02
Simon
30cm 11 3/4"
Uterine Scoop
11,6 x 8,3 mm
sharp, rigid



IM-17-635-03
Simon
31cm 12 1/4"
Uterine Scoop
13,2 x 10,0 mm
sharp, rigid



IM-17-635-04
Simon
31cm 12 1/4"
Uterine Scoop
16,0 x 11,6 mm
sharp, rigid





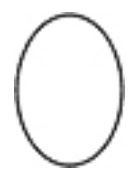















IM-17-635-05
Simon
31cm 12 1/4"
Uterine Scoop
18,0 x 12,6 mm
sharp, rigid



IM-17-635-06
Simon
31cm 12 1/4"
Uterine Scoop
20,0 x 13,8 mm
sharp, rigid

Gynecology





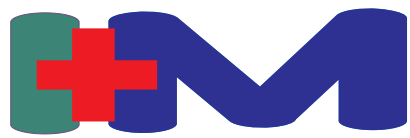









					
IM-17-640-05 Recamier 31cm 12 1/4" Uterine Curette Fig. 00 5 mm sharp, rigid	IM-17-640-06 Recamier 31cm 12 1/4" Uterine Curette Fig. 0 6 mm sharp, rigid	IM-17-640-07 Recamier 31cm 12 1/4" Uterine Curette Fig. 1 7 mm sharp, rigid	IM-17-640-08 Recamier 31cm 12 1/4" Uterine Curette Fig. 2 8 mm sharp, rigid	IM-17-640-09 Recamier 31cm 12 1/4" Uterine Curette Fig. 3 9 mm sharp, rigid	IM-17-640-11 Recamier 31cm 12 1/4" Uterine Curette Fig. 4 11 mm sharp, rigid
					
IM-17-640-12 Recamier 31cm 12 1/4" Uterine Curette Fig. 5 12 mm sharp, rigid	IM-17-640-14 Recamier 31cm 12 1/4" Uterine Curette Fig. 6 14 mm sharp, rigid	IM-17-640-15 Recamier 31cm 12 1/4" Uterine Curette Fig. 7 15 mm sharp, rigid	IM-17-640-16 Recamier 31cm 12 1/4" Uterine Curette Fig. 8 16 mm sharp, rigid	IM-17-640-19 Recamier 31cm 12 1/4" Uterine Curette Fig. 9 19 mm sharp, rigid	IM-17-640-20 Recamier 31cm 12 1/4" Uterine Curette Fig. 10 20 mm sharp, rigid
					
IM-17-640-21 Recamier 31cm 12 1/4" Uterine Curette Fig. 11 21 mm sharp, rigid	IM-17-640-23 Recamier 31cm 12 1/4" Uterine Curette Fig. 12 23 mm sharp, rigid	IM-17-640-25 Recamier 34cm 13 1/2" Uterine Curette Fig. 13 25 mm sharp, rigid	IM-17-640-30 Recamier 35cm 13 3/4" Uterine Curette Fig. 14 30 mm sharp, rigid	IM-17-640-35 Recamier 35cm 13 3/4" Uterine Curette Fig. 15 35 mm sharp, rigid	IM-17-640-40 Recamier 35cm 13 3/4" Uterine Curette Fig. 16 40 mm sharp, rigid









Gynecology





















					
IM-17-645-05	IM-17-645-06	IM-17-645-07	IM-17-645-08	IM-17-645-09	IM-17-645-11
Recamier	Recamier	Recamier	Recamier	Recamier	Recamier
31cm 12 1/4"	31cm 12 1/4"	31cm 12 1/4"	31cm 12 1/4"	31cm 12 1/4"	31cm 12 1/4"
Uterine Curette	Uterine Curette	Uterine Curette	Uterine Curette	Uterine Curette	Uterine Curette
Fig. 00	Fig. 0	Fig. 1	Fig. 2	Fig. 3	Fig. 4
5 mm	6 mm	7 mm	8 mm	9 mm	11 mm
sharp, malleable sharp, malleable sharp, malleable sharp, malleable sharp, malleable					

					
IM-17-645-12	IM-17-645-14	IM-17-645-15	IM-17-645-16	IM-17-645-19	IM-17-645-20
Recamier	Recamier	Recamier	Recamier	Recamier	Recamier
31cm 12 1/4"	31cm 12 1/4"	31cm 12 1/4"	31cm 12 1/4"	31cm 12 1/4"	31cm 12 1/4"
Uterine Curette	Uterine Curette	Uterine Curette	Uterine Curette	Uterine Curette	Uterine Curette
Fig. 5	Fig. 6	Fig. 7	Fig. 8	Fig. 9	Fig. 10
12 mm	14 mm	15 mm	16 mm	19 mm	20 mm
sharp, malleable sharp, malleable sharp, malleable sharp, malleable sharp, malleable					

					
IM-17-645-21	IM-17-645-23	IM-17-645-25	IM-17-645-30	IM-17-645-35	IM-17-64540
Recamier	Recamier	Recamier	Recamier	Recamier	Recamier
31cm 12 1/4"	31cm 12 1/4"	34cm 13 1/2"	35cm 13 3/4"	35cm 13 3/4"	35cm 13 3/4"
Uterine Curette	Uterine Curette	Uterine Curette	Uterine Curette	Uterine Curette	Uterine Curette
Fig. 11	Fig. 12	Fig. 13	Fig. 14	Fig. 15	Fig. 16
21 mm	23 mm	25 mm	30 mm	35 mm	40 mm
sharp, malleable sharp, malleable sharp, malleable sharp, malleable sharp, malleable					

Gynecology



					
IM-17-650-05 Sims 31cm 12 1/4" Uterine Curette Fig. 00 5 mm blunt, rigid	IM-17-650-06 Sims 31cm 12 1/4" Uterine Curette Fig. 0 6 mm blunt	IM-17-650-07 Sims 31cm 12 1/4" Uterine Curette Fig. 1 7 mm blunt	IM-17-650-08 Sims 31cm 12 1/4" Uterine Curette Fig. 2 8 mm blunt	IM-17-650-09 Sims 31cm 12 1/4" Uterine Curette Fig. 3 9 mm blunt	IM-17-650-11 Sims 31cm 12 1/4" Uterine Curette Fig. 4 11 mm blunt
					
IM-17-650-12 Sims 31cm 12 1/4" Uterine Curette Fig. 5 12 mm blunt	IM-17-650-14 Sims 31cm 12 1/4" Uterine Curette Fig. 6 14 mm blunt	IM-17-650-15 Sims 31cm 12 1/4" Uterine Curette Fig. 7 15 mm blunt	IM-17-650-16 Sims 31cm 12 1/4" Uterine Curette Fig. 8 16 mm blunt	IM-17-650-19 Sims 31cm 12 1/4" Uterine Curette Fig. 9 19 mm blunt	IM-17-650-20 Sims 31cm 12 1/4" Uterine Curette Fig. 10 20 mm blunt
					
IM-17-650-21 Sims 31cm 12 1/4" Uterine Curette Fig. 11 21 mm blunt	IM-17-650-23 Sims 31cm 12 1/4" Uterine Curette Fig. 12 23 mm blunt	IM-17-650-25 Sims 34cm 13 1/2" Uterine Curette Fig. 13 25 mm blunt	IM-17-650-30 Sims 35cm 13 3/4" Uterine Curette Fig. 14 30 mm blunt	IM-17-650-35 Sims 35cm 13 3/4" Uterine Curette Fig. 15 35 mm blunt	IM-17-650-40 Sims 35cm 13 3/4" Uterine Curette Fig. 16 40 mm blunt

Gynecology



IM-17-655-05 Sims 31cm 12 1/4" Uterine Curette Fig. 00 5 mm blunt, malleable	IM-17-655-06 Sims 31cm 12 1/4" Uterine Curette Fig. 0 6 mm blunt, malleable	IM-17-655-07 Sims 31cm 12 1/4" Uterine Curette Fig. 1 7 mm blunt, malleable	IM-17-655-08 Sims 31cm 12 1/4" Uterine Curette Fig. 2 8 mm blunt, malleable	IM-17-655-09 Sims 31cm 12 1/4" Uterine Curette Fig. 3 9 mm blunt, malleable	-11 Sims 31cm 12 1/4" Uterine Curette Fig. 4 11 mm blunt, malleable
IM-17-655-12 Sims 31cm 12 1/4" Uterine Curette Fig. 5 12 mm blunt, malleable	IM-17-655-14 Sims 31cm 12 1/4" Uterine Curette Fig. 6 14 mm blunt, malleable	IM-17-655-15 Sims 31cm 12 1/4" Uterine Curette Fig. 7 15 mm blunt, malleable	IM-17-655-16 Sims 31cm 12 1/4" Uterine Curette Fig. 8 16 mm blunt, malleable	IM-17-655-19 Sims 31cm 12 1/4" Uterine Curette Fig. 9 19 mm blunt, malleable	IM-17-655-20 Sims 31cm 12 1/4" Uterine Curette Fig. 10 20 mm blunt, malleable
IM-17-655-21 Sims 31cm 12 1/4" Uterine Curette Fig. 11 21 mm blunt, malleable	IM-17-655-23 Sims 31cm 12 1/4" Uterine Curette Fig. 12 23 mm blunt, malleable	IM-17-655-25 Sims 34cm 13 1/2" Uterine Curette Fig. 13 25 mm blunt, malleable	IM-17-655-30 Sims 35cm 13 3/4" Uterine Curette Fig. 14 30 mm blunt, malleable	IM-17-655-35 Sims 35cm 13 3/4" Uterine Curette Fig. 15 35 mm blunt, malleable	IM-17-655-40 Sims 35cm 13 3/4" Uterine Curette Fig. 16 40 mm blunt, malleable

Gynecology



IM-17-660-03
29cm 11 1/2"
Suction Curette
3,0 mm Ø

IM-17-660-04
29cm 11 1/2"
Suction Curette
4,5 mm Ø

IM-17-660-06
29cm 11 1/2"
Suction Curette
6,0 mm Ø

Gynecology



IM-17-660-08
29cm 11 1/2"
Suction Curette
8,0 mm Ø

IM-17-660-10
29cm 11 1/2"
Suction Curette
9,0 mm Ø

IM-17-660-12
29cm 11 1/2"
Suction Curette
12,0 mm Ø

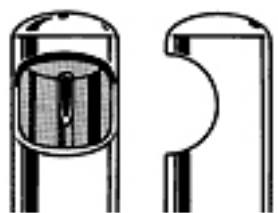

IM-17-665-14
29cm 11 1/2"
Suction Curette
14,0 mm Ø



IM-17-670-50
12cm 4 3/4"
Coupling Piece

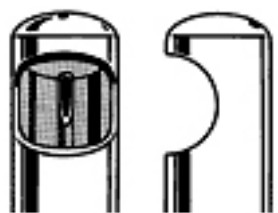

IM-17-665-14
29cm 11 1/2"
Suction Curette
14,0 mm Ø



IM-17-670-50
12cm 4 3/4"
Coupling Piece

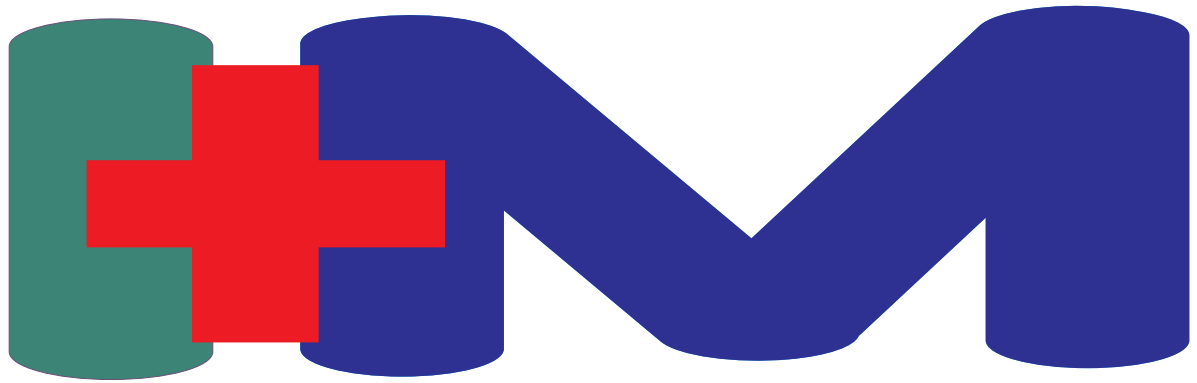

IBRAHIM MEDS

I N S T R U M E N T S

 77 A Model Town Ugoki Sialkot

 +92 52 3512235

 +92 52 4007564

 +92 300 7163508 , +92 307 6427547

 info@ibrahimmeds.com

 amjad@ibrahimmeds.com

 www.ibrahimmeds.com