

WE SERVE HUMANITY WITH EXCELLENCE

IBRAHIM MEDS

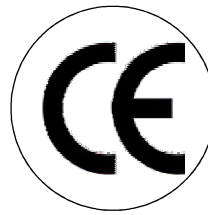

PLASTIC SURGERY INSTRUMENTS

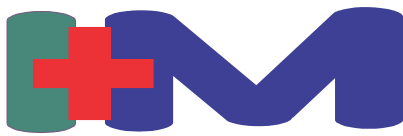

Fiber Optic Tools

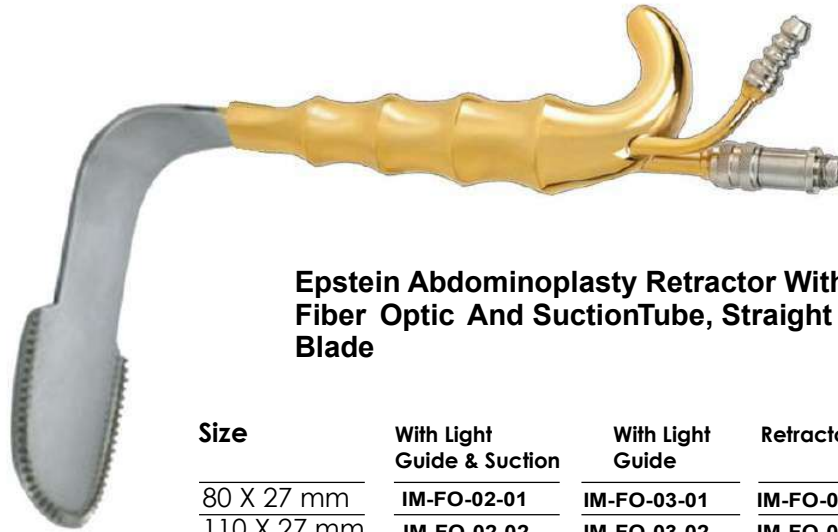

Epstein Abdominoplasty Retractor With Fiber Optic And Suction Tube, Straight Blade

Size	With Light Guide & Suction	With Light Guide	Retractor Only	Suction Only
80 X 27 mm	IM-FO-02-01	IM-FO-03-01	IM-FO-04-01	IM-FO-05-01
110 X 27 mm	IM-FO-02-02	IM-FO-03-02	IM-FO-04-02	IM-FO-05-02
140 X 27 mm	IM-FO-02-03	IM-FO-03-03	IM-FO-04-03	IM-FO-05-03
160 X 27 mm	IM-FO-02-04	IM-FO-03-04	IM-FO-04-04	IM-FO-05-04
240 X 27 mm	IM-FO-02-05	IM-FO-03-05	IM-FO-04-05	IM-FO-05-05



Epstein Abdominoplasty Retractor With Fiber Optic And Suction Tube, Curved Blade

Size	With Light Guide & Suction	With Light Guide	Retractor Only	Suction Only
80 X 27 mm	IM-FO-06-01	IM-FO-07-01	IM-FO-08-01	IM-FO-09-01
110 X 27 mm	IM-FO-06-02	IM-FO-07-02	IM-FO-08-02	IM-FO-09-02
140 X 27 mm	IM-FO-06-03	IM-FO-07-03	IM-FO-08-03	IM-FO-09-03
160 X 27 mm	IM-FO-06-04	IM-FO-07-04	IM-FO-08-04	IM-FO-09-04
240 X 27 mm	IM-FO-06-05	IM-FO-07-05	IM-FO-08-05	IM-FO-09-05



**Haynes Breast Retractor, Slotted Blade With Teeth
With Fiber Optic Light Guide**

<u>Size</u>	<u>With Light Guide</u>	<u>Retractor Only</u>
<u>90 X 32 mm</u>	<u>IM-FO-10-01</u>	<u>IM-FO-11-01</u>
<u>140 X 32 mm</u>	<u>IM-FO-10-02</u>	<u>IM-FO-11-02</u>



FERRIERA STYLE BREAST RETRACTOR

Size	With Light Guide & Suction	With Light Guide	Retractor Only	Suction Only
70 X 16 mm	IM-FO-12-01	IM-FO-13-01	IM-FO-14-01	IM-FO-15-01
80 X 16 mm	IM-FO-12-02	IM-FO-13-02	IM-FO-14-02	IM-FO-15-02
90 X 27 mm	IM-FO-12-03	IM-FO-13-03	IM-FO-14-03	IM-FO-15-03
110 X 25 mm	IM-FO-12-04	IM-FO-13-04	IM-FO-14-04	IM-FO-15-04
120 X 25 mm	IM-FO-12-05	IM-FO-13-05	IM-FO-14-05	IM-FO-15-05
130 X 16 mm	IM-FO-12-06	IM-FO-13-06	IM-FO-14-06	IM-FO-15-06
130 X 25 mm	IM-FO-12-07	IM-FO-13-07	IM-FO-14-07	IM-FO-15-07
150 X 25 mm	IM-FO-12-08	IM-FO-13-08	IM-FO-14-08	IM-FO-15-08
150 X 30 mm	IM-FO-12-09	IM-FO-13-09	IM-FO-14-09	IM-FO-15-09
150 X 36 mm	IM-FO-12-10	IM-FO-13-10	IM-FO-14-10	IM-FO-15-10
180 X 16 mm	IM-FO-12-11	IM-FO-13-11	IM-FO-14-11	IM-FO-15-11
180 X 25 mm	IM-FO-12-12	IM-FO-13-12	IM-FO-14-12	IM-FO-15-12
190 X 25 mm	IM-FO-12-13	IM-FO-13-13	IM-FO-14-13	IM-FO-15-13
190 X 36 mm	IM-FO-12-14	IM-FO-13-14	IM-FO-14-14	IM-FO-15-14
220 X 27 mm	IM-FO-12-15	IM-FO-13-15	IM-FO-14-15	IM-FO-15-15



**Ferriera Style Breast Fiber Optic Retractor, With
Double Handle and Smooth End**

Size	With Light Guide & Suction	With Light Guide	Retractor Only	Suction Only
70 X 16 mm	IM-FO-16-01	IM-FO-17-01	IM-FO-18-01	IM-FO-19-01
80 X 16 mm	IM-FO-16-02	IM-FO-17-02	IM-FO-18-02	IM-FO-19-02
90 X 27 mm	IM-FO-16-03	IM-FO-17-03	IM-FO-18-03	IM-FO-19-03
110 X 25 mm	IM-FO-16-04	IM-FO-17-04	IM-FO-18-04	IM-FO-19-04
120 X 25 mm	IM-FO-16-05	IM-FO-17-05	IM-FO-18-05	IM-FO-19-05
130 X 16 mm	IM-FO-16-06	IM-FO-17-06	IM-FO-18-06	IM-FO-19-06
130 X 25 mm	IM-FO-16-07	IM-FO-17-07	IM-FO-18-07	IM-FO-19-07
150 X 25 mm	IM-FO-16-08	IM-FO-17-08	IM-FO-18-08	IM-FO-19-08
150 X 30 mm	IM-FO-16-09	IM-FO-17-09	IM-FO-18-09	IM-FO-19-09
150 X 36 mm	IM-FO-16-10	IM-FO-17-10	IM-FO-18-10	IM-FO-19-10
180 X 16 mm	IM-FO-16-11	IM-FO-17-11	IM-FO-18-11	IM-FO-19-11
180 X 25 mm	IM-FO-16-12	IM-FO-17-12	IM-FO-18-12	IM-FO-19-12
190 X 25 mm	IM-FO-16-13	IM-FO-17-13	IM-FO-18-13	IM-FO-19-13
190 X 36 mm	IM-FO-16-14	IM-FO-17-14	IM-FO-18-14	IM-FO-19-14
220 X 27 mm	IM-FO-16-15	IM-FO-17-15	IM-FO-18-15	IM-FO-19-15

Fiber Optic Tools

Tebbetts Fibre Optic Breast Retractor
With fibre optic illumination and suction

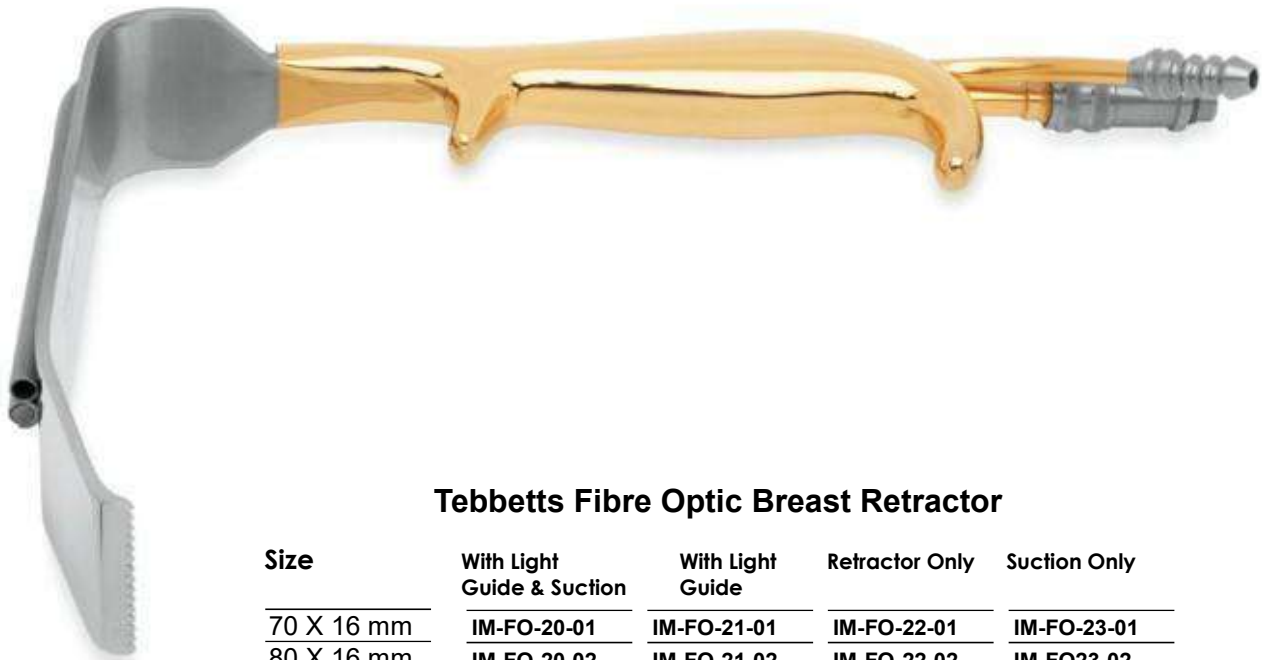
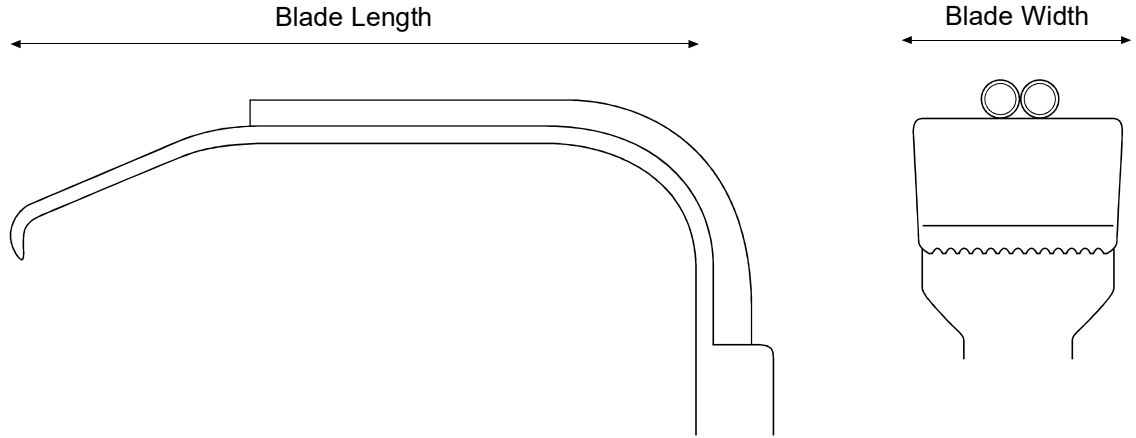

Tebbetts Fibre Optic Breast Retractor

Size	With Light Guide & Suction	With Light Guide	Retractor Only	Suction Only
70 X 16 mm	IM-FO-20-01	IM-FO-21-01	IM-FO-22-01	IM-FO-23-01
80 X 16 mm	IM-FO-20-02	IM-FO-21-02	IM-FO-22-02	IM-FO-23-02
90 X 27 mm	IM-FO-20-03	IM-FO-21-03	IM-FO-22-03	IM-FO-23-03
110 X 25 mm	IM-FO-20-04	IM-FO-21-04	IM-FO-22-04	IM-FO-23-04
120 X 25 mm	IM-FO-20-05	IM-FO-21-05	IM-FO-22-05	IM-FO-23-05
130 X 16 mm	IM-FO-20-06	IM-FO-21-06	IM-FO-22-06	IM-FO-23-06
130 X 25 mm	IM-FO-20-07	IM-FO-21-07	IM-FO-22-07	IM-FO-23-07
150 X 25 mm	IM-FO-20-08	IM-FO-21-08	IM-FO-22-08	IM-FO-23-08
150 X 30 mm	IM-FO-20-09	IM-FO-21-09	IM-FO-22-09	IM-FO-23-09
150 X 36 mm	IM-FO-20-10	IM-FO-21-10	IM-FO-22-10	IM-FO-23-10
180 X 16 mm	IM-FO-20-11	IM-FO-21-11	IM-FO-22-11	IM-FO-23-11
180 X 25 mm	IM-FO-20-12	IM-FO-21-12	IM-FO-22-12	IM-FO-23-12
190 X 25 mm	IM-FO-20-13	IM-FO-21-13	IM-FO-22-13	IM-FO-23-13
190 X 36 mm	IM-FO-20-14	IM-FO-21-14	IM-FO-22-14	IM-FO-23-14
220 X 27 mm	IM-FO-20-15	IM-FO-21-15	IM-FO-22-15	IM-FO-23-15

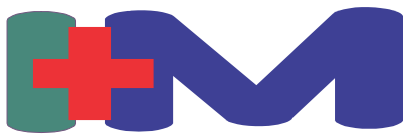

Fiber Optic Tools



TEBBETTS RETRACTOR, With Double Handle and Teeth at tip

Size	With Light Guide & Suction	With Light Guide	Retractor Only	Suction Only
70 X 16 mm	IM-FO-24-01	IM-FO-25-01	IM-FO-26-01	IM-FO-27-01
80 X 16 mm	IM-FO-24-02	IM-FO-25-02	IM-FO-26-02	IM-FO-27-02
90 X 27 mm	IM-FO-24-03	IM-FO-25-03	IM-FO-26-03	IM-FO-27-03
110 X 25 mm	IM-FO-24-04	IM-FO-25-04	IM-FO-26-04	IM-FO-27-04
120 X 25 mm	IM-FO-24-05	IM-FO-25-05	IM-FO-26-05	IM-FO-27-05
130 X 16 mm	IM-FO-24-06	IM-FO-25-06	IM-FO-26-06	IM-FO-27-06
130 X 25 mm	IM-FO-24-07	IM-FO-25-07	IM-FO-26-07	IM-FO-27-07
150 X 25 mm	IM-FO-24-08	IM-FO-25-08	IM-FO-26-08	IM-FO-27-08
150 X 30 mm	IM-FO-24-09	IM-FO-25-09	IM-FO-26-09	IM-FO-27-09
150 X 36 mm	IM-FO-24-10	IM-FO-25-10	IM-FO-26-10	IM-FO-27-10
180 X 16 mm	IM-FO-24-11	IM-FO-25-11	IM-FO-26-11	IM-FO-27-11
180 X 25 mm	IM-FO-24-12	IM-FO-25-12	IM-FO-26-12	IM-FO-27-12
190 X 25 mm	IM-FO-24-13	IM-FO-25-13	IM-FO-26-13	IM-FO-27-13
190 X 36 mm	IM-FO-24-14	IM-FO-25-14	IM-FO-26-14	IM-FO-27-14
220 X 27 mm	IM-FO-24-15	IM-FO-25-15	IM-FO-26-15	IM-FO-27-15

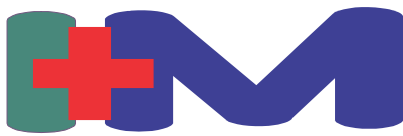

Fiber Optic Tools

TEBBETTS RETRACTOR, Insulated Blade with Teeth



Size	With Light Guide & Suction	With Light Guide	Retractor Only	Suction Only
70 X 16 mm	IM-FO-28-01	IM-FO-29-01	IM-FO-30-01	IM-FO-31-01
80 X 16 mm	IM-FO-28-02	IM-FO-29-02	IM-FO-30-02	IM-FO-31-02
90 X 27 mm	IM-FO-28-03	IM-FO-29-03	IM-FO-30-03	IM-FO-31-03
110 X 25 mm	IM-FO-28-04	IM-FO-29-04	IM-FO-30-04	IM-FO-31-04
120 X 25 mm	IM-FO-28-05	IM-FO-29-05	IM-FO-30-05	IM-FO-31-05
130 X 16 mm	IM-FO-28-06	IM-FO-29-06	IM-FO-30-06	IM-FO-31-06
130 X 25 mm	IM-FO-28-07	IM-FO-29-07	IM-FO-30-07	IM-FO-31-07
150 X 25 mm	IM-FO-28-08	IM-FO-29-08	IM-FO-30-08	IM-FO-31-08
150 X 30 mm	IM-FO-28-09	IM-FO-29-09	IM-FO-30-09	IM-FO-31-09
150 X 36 mm	IM-FO-28-10	IM-FO-29-10	IM-FO-30-10	IM-FO-31-10
180 X 16 mm	IM-FO-28-11	IM-FO-29-11	IM-FO-30-11	IM-FO-31-11
180 X 25 mm	IM-FO-28-12	IM-FO-29-12	IM-FO-30-12	IM-FO-31-12
190 X 25 mm	IM-FO-28-13	IM-FO-29-13	IM-FO-30-13	IM-FO-31-13
190 X 36 mm	IM-FO-28-14	IM-FO-29-14	IM-FO-30-14	IM-FO-31-14
220 X 27 mm	IM-FO-28-15	IM-FO-29-15	IM-FO-30-15	IM-FO-31-15

Ferriera Style Breast Fiber Optic Retractor, Insulated Blade With Smooth End

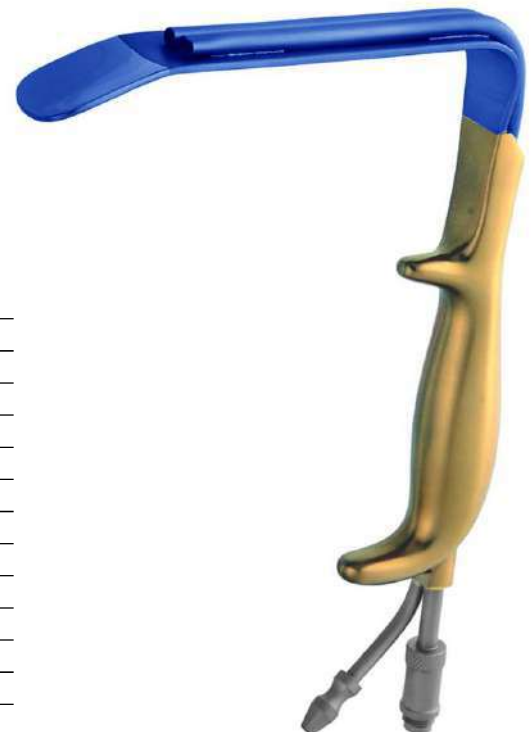

Size	With Light Guide & Suction	With Light Guide	Retractor Only	Suction Only
70 X 16 mm	IM-FO-32-01	IM-FO-33-01	IM-FO-34-01	IM-FO-35-01
80 X 16 mm	IM-FO-32-02	IM-FO-33-02	IM-FO-34-02	IM-FO-35-02
90 X 27 mm	IM-FO-32-03	IM-FO-33-03	IM-FO-34-03	IM-FO-35-03
110 X 25 mm	IM-FO-32-04	IM-FO-33-04	IM-FO-34-04	IM-FO-35-04
120 X 25 mm	IM-FO-32-05	IM-FO-33-05	IM-FO-34-05	IM-FO-35-05
130 X 16 mm	IM-FO-32-06	IM-FO-33-06	IM-FO-34-06	IM-FO-35-06
130 X 25 mm	IM-FO-32-07	IM-FO-33-07	IM-FO-34-07	IM-FO-35-07
150 X 25 mm	IM-FO-32-08	IM-FO-33-08	IM-FO-34-08	IM-FO-35-08
150 X 30 mm	IM-FO-32-09	IM-FO-33-09	IM-FO-34-09	IM-FO-35-09
150 X 36 mm	IM-FO-32-10	IM-FO-33-10	IM-FO-34-10	IM-FO-35-10
180 X 16 mm	IM-FO-32-11	IM-FO-33-11	IM-FO-34-11	IM-FO-35-11
180 X 25 mm	IM-FO-32-12	IM-FO-33-12	IM-FO-34-12	IM-FO-35-12
190 X 25 mm	IM-FO-32-13	IM-FO-33-13	IM-FO-34-13	IM-FO-35-13
190 X 36 mm	IM-FO-32-14	IM-FO-33-14	IM-FO-34-14	IM-FO-35-14
220 X 27 mm	IM-FO-32-15	IM-FO-33-15	IM-FO-34-15	IM-FO-35-15

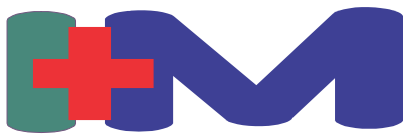

Fiber Optic Tools

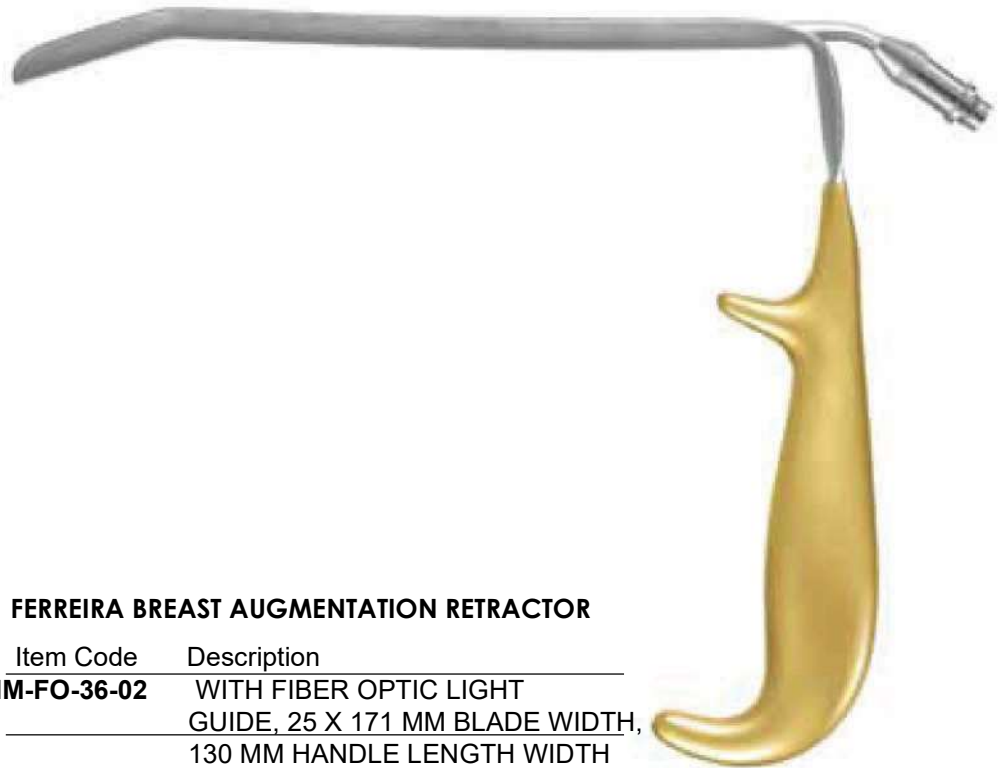

FERREIRA BREAST AUGMENTATION RETRACTOR

Item Code	Description
IM-FO-36-02	WITH FIBER OPTIC LIGHT GUIDE, 25 X 171 MM BLADE WIDTH, 130 MM HANDLE LENGTH WIDTH



Sculpo Breast Retractors

Item Code	Description
IM-FO-37-02	180 X 25mm, Blade Size, With 5mm Endoscopic Scope Sheath
IM-FO-38-02	180 X 25mm, Blade Size, With 10mm Endoscopic Scope Sheath

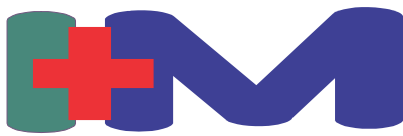

IBRAHIM MEDS

WE SERVE HUMANITY WITH EXCELLENCE



Ring Breast Retractor

with fiber optic illumination and irrigation tube

Description

IM-FO-39-01



Ring Breast Retractor

with fiber optic illumination and irrigation tube , Insulated

Description

IM-FO-40-01

Fiber Optic Tools



BIGGS MAMMAPLASTY RETRACTOR

Item Code	Description
IM-FO-41-01	WITH FIBER OPTIC LIGHT GUIDE 5.0 CM BLADE WIDTH, 20 CM LENGTH



BIGGS MAMMAPLASTY RETRACTOR

Item Code	Description
IM-FO-42-01	WITH FIBER OPTIC LIGHT GUIDE, NARROW, 3.0 CM BLADE WIDTH, 15 CM LENGTH



BIGGS MAMMAPLASTY RETRACTORS

Item Code	Description
IM-FO-43-01	30MM, WITH FIBER OPTIC LIGHT GUIDE
IM-FO-43-02	50MM, WITH FIBER OPTIC LIGHT GUIDE
IM-FO-43-03	30MM, WITH FIBER OPTIC LIGHT GUIDE AND SUCTION
IM-FO-43-04	50MM, WITH FIBER OPTIC LIGHT GUIDE AND SUCTION



Miller Wave Retractor

Item Code	Description
IM-FO-44-01	WITHOUT FIBER OPTIC LIGHT GUIDE
IM-FO-44-02	WITH FIBER OPTIC LIGHT GUIDE
IM-FO-44-03	WITH FIBER OPTIC LIGHT GUIDE AND SUCTION

Fiber Optic Tools

Fibre Optic Light Lead

Code	Length	Diameter
IM-FO-45-01	225cm	4.0mm Ø
IM-FO-45-02	250cm	4.0mm Ø
IM-FO-45-03	300cm	4.0mm Ø
IM-FO-45-04	400cm	4.0mm Ø



Adaptors for Light Lead

Lightsource Fittings



Retractor Fitting



Wireless LED Light Source For Fiber Optic Retractor (Great LED White Light)

IM-FO-46-01



Emory Endoscopic Retractor, With Locking Mechanism
1 X 7 Inch Blades, For 10mm Scope
IM-FO-49-01



Harrington Wide Retractor With Fiber
Optics Illumination, 32cm

IM-FO -50-01



**Aufricht Retractor With Fiber Optic
Illumination 20cm, Fixed
IM-FO-51-01**



**Aufricht Retractor With Fiber Optic
Illumination 20cm
IM-FO-52-01**

Fiber Optic Tools



**BIGGS face lift retractor, 50 mm, Retractor Only, Length (23cm)
IM-FO-53-01**

**BIGGS face lift retractor, 50 mm, With Fiber Optic Guide, Length (23cm)
IM-FO-54-01**

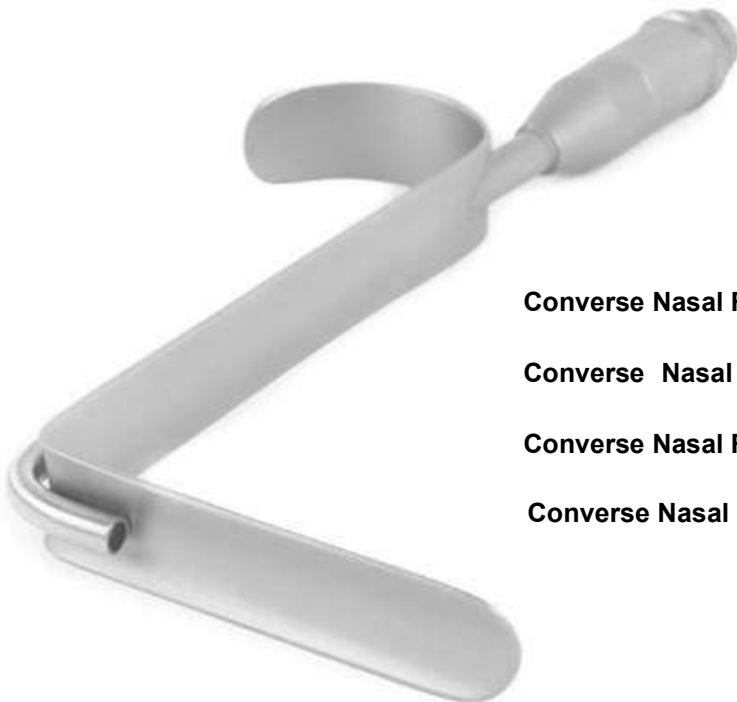

**Converse Nasal Retractor With Fiber Optic 20mm x 10mm Wide
IM-FO-55-01**

**Converse Nasal Retractor With Fiber Optic 30mm x 12mm Wide
IM-FO-56-01**

**Converse Nasal Retractor With Fiber Optic 40mm x 12mm Wide
IM-FO-57-01**

**Converse Nasal Retractor With Fiber Optic 50mm x 12mm Wide
IM-FO-58-01**

Fiber Optic Tools



Weider Breast And Facial Retractor With Fiber Optic Light Guide 14cm

IM-FO -59-01

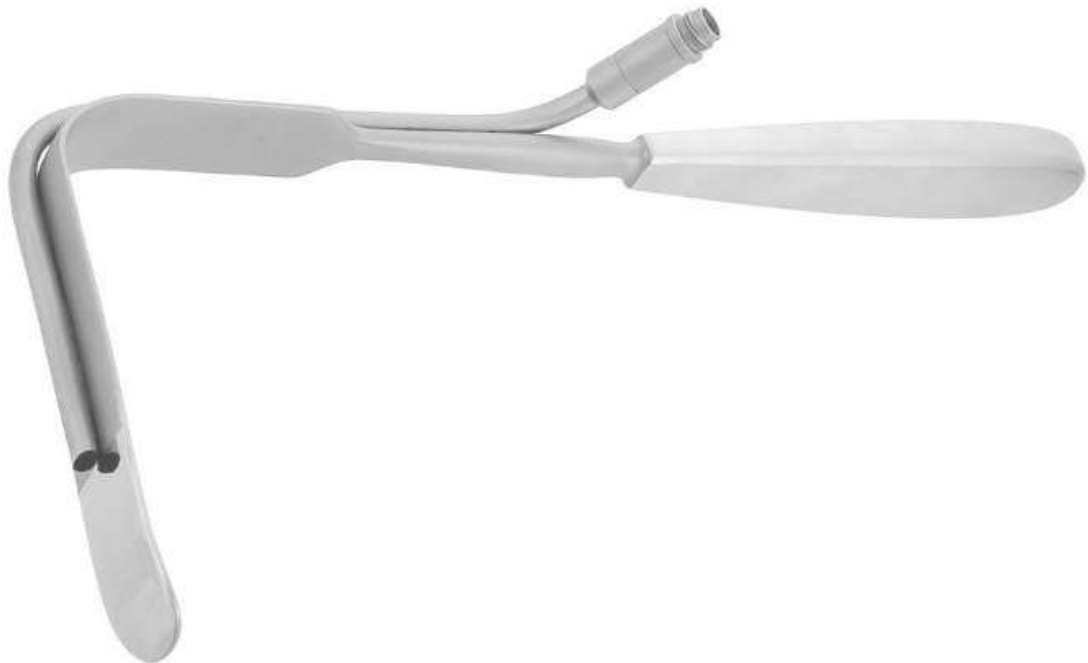

Heaney Simon Retractor With Fiber Optic Guide Light 130mm x 25mm Blade Width

IM-FO-60-01

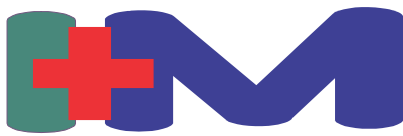

Fiber Optic Tools



**Cottle Nasal Speculum 14CM,
WITH FIBER OPTIC LIGHT GUIDE**

Item Code	Description
IM-FO-61-40	40MM WIDE
IM-FO-61-55	55MM WIDE
IM-FO-61-75	75MM WIDE
IM-FO-61-90	90MM WIDE,



**Killian Nasal Speculum 14CM,
WITH FIBER OPTIC LIGHT GUIDE**

Item Code	Description
IM-FO-62-40	40MM WIDE
IM-FO-62-55	55MM WIDE
IM-FO-62-75	75MM WIDE
IM-FO-62-90	90MM WIDE,

Fiber Optic Tools



Maliniac Nasal Retractor 9mm x 45mm Blade Size, With Fiber Optic Guide Light

IM-FO-63-01

Maliniac Nasal Retractor 11mm x 44mm Blade Size, With Fiber Optic Guide Light

IM-FO-64-01

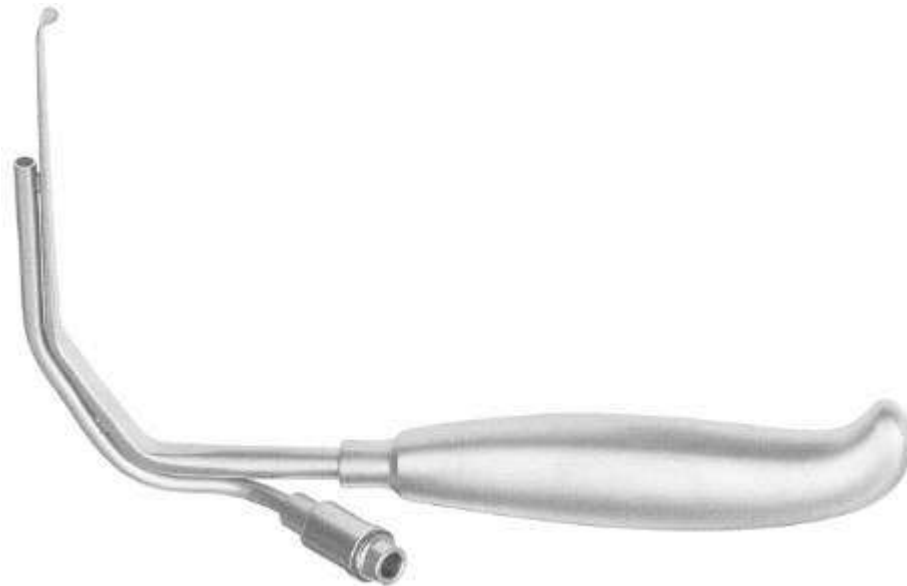

Walter Alar and Nasal Retractor, 18.5cm

IM-FO-65-01

Fiber Optic Tools



Deaver Retractor With Fiber Optic Illumination 20cm 16mm Wide

IM-FO-66-01

Deaver Retractor With Fiber Optic Illumination 20cm 25mm Wide

IM-FO-67-01



Freeman Flap Retractor 20cm 12mm Blade Wide, With Fiber Optic Guide Light

IM-FO-68-01

Freeman Flap Retractor 20cm 25mm Blade Wide, With Fiber Optic Guide Light

IM-FO-69-01

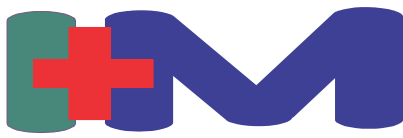

IBRAHIM MEDS

WE SERVE HUMANITY WITH EXCELLENCE

BREAST RETRACTORS



IM-BR-70.01

28 cm / 11"

Mammoplast Breast Retractor

Self retaining ratchet

Adjustable to hold breast during surgery

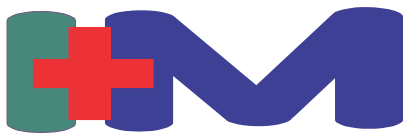

BREAST RETRACTORS



BREAST RETRACTOR

Item Code	Description
IM-BR-71.01	DOUBLE ENDED, (31 CM), BLADES 22MM X 55MM AND 38MM X 70MM
IM-BR-72.02	DOUBLE ENDED, (24 CM), BLADES 22MM X 55MM AND 38MM X 70MM

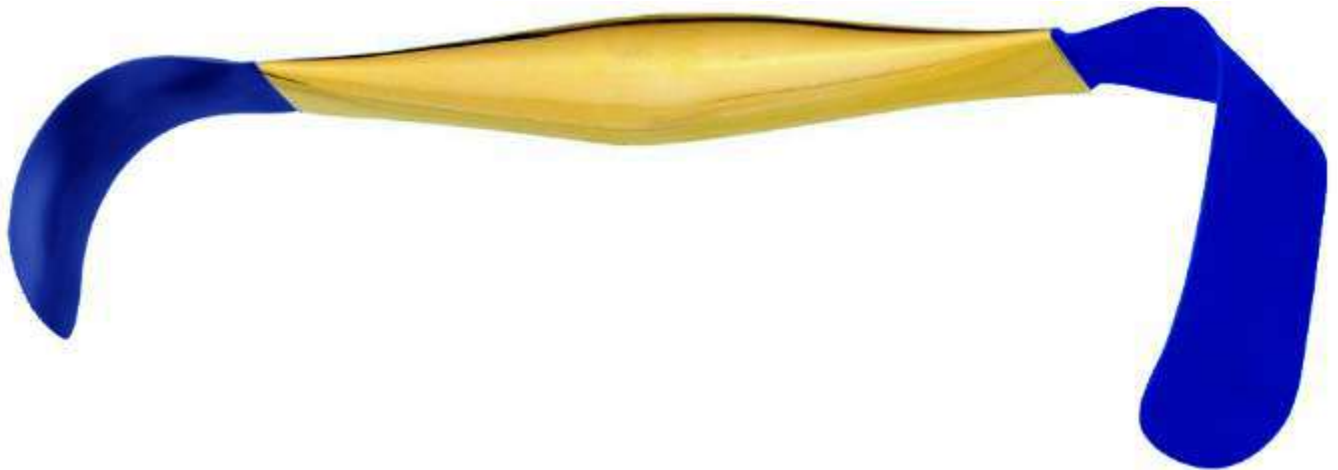

BREAST RETRACTOR INSULATED

Item Code	Description
IM-BR-73.01	DOUBLE ENDED, (31 CM), BLADES 22MM X 55MM AND 38MM X 70MM
IM-BR-74.02	DOUBLE ENDED, (24 CM), BLADES 22MM X 55MM AND 38MM X 70MM

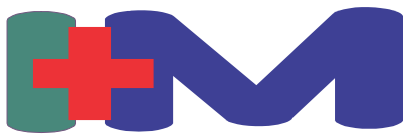

BREAST RETRACTORS



BREAST RETRACTOR

Item Code	Description
IM-BR-75.01	DOUBLE ENDED, (31 CM), BLADES 22MM X 55MM AND 38MM X 70MM
IM-BR-76.02	DOUBLE ENDED, (24 CM), BLADES 22MM X 55MM AND 38MM X 70MM



BREAST RETRACTOR INSULATED

Item Code	Description
IM-BR-77.01	DOUBLE ENDED, (31 CM), BLADES 22MM X 55MM AND 38MM X 70MM
IM-BR-78.02	DOUBLE ENDED, (24 CM), BLADES 22MM X 55MM AND 38MM X 70MM

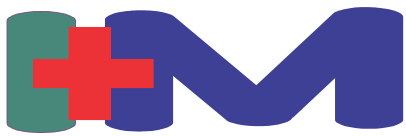

BREAST RETRACTORS



BIGGS MAMMAPLASTY RETRACTOR,

Item Code	Description
IM-BR-79.01	3 CM BLADE WIDTH, NARROW, (171 MM) LENGTH



BIGGS MAMMAPLASTY RETRACTOR

Item Code	Description
IM-BR-80.01	50 MM WIDTH, STANDARD, 20 CM LENGTH

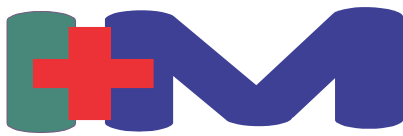

IBRAHIM MEDS

WE SERVE HUMANITY WITH EXCELLENCE

BREAST RETRACTORS



MARX BREAST RETRACTOR

Item Code	Description
IM-BR-81.01	27CM, 125 X 30MM
IM-BR-82.02	27CM, 140 X 30MM

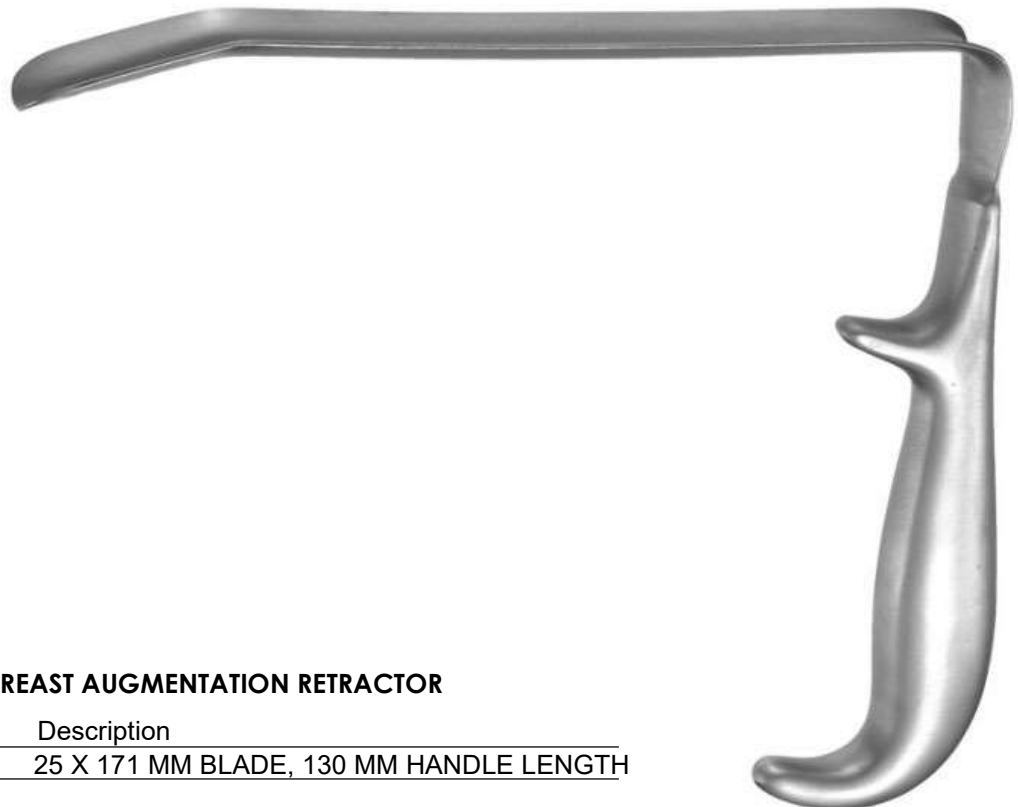

FERREIRA BREAST AUGMENTATION RETRACTOR

Item Code	Description
IM-BR-83.01	25 X 171 MM BLADE, 130 MM HANDLE LENGTH

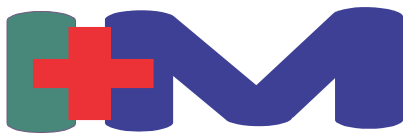

IBRAHIM MEDS

WE SERVE HUMANITY WITH EXCELLENCE

BREAST RETRACTORS



WIEDER BREAST AND FACIAL RETRACTOR / TONGUE DEPRESSOR

Item Code	Description
IM-BR-84.01	SERRATED, (14 CM), 28MM
IM-BR-85.02	SERRATED, (14 CM), 38MM
IM-BR-86.03	SERRATED, (15 CM), 45MM

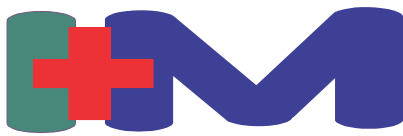

BREAST RETRACTORS & ELEVATORS



MACCOLLUM DINGMAN BREAST DISSECTOR

Item Code	Description
IM-BRE-90.01	31.5 CM
IM-BRE-91.02	41 CM



MACCOLLUM DINGMAN BREAST DISSECTOR

Item Code	Description
IM-BRE-93.01	1½" (38 MM) WIDTH, 17½" (432 MM) LENGTH



BREAST DISSECTOR

Item Code	Description
IM-BRE-94.01	SPATULATED BLADE, 33CM
IM-BRE-95.02	SPATULATED BLADE, 42CM



BREAST DISSECTOR

Item Code	Description
IM-BRE-96.01	OVAL SPATULATED BLADE, 33CM
IM-BRE-97.02	OVAL SPATULATED BLADE, 42CM

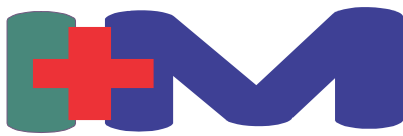

BREAST RETRACTORS & ELEVATORS



REYNOLDS TRANSAUXILLARY BREAST DISSECTOR

Item Code	Description
IM-BRE-100.01	FENESTRATED, 33CM
IM-BRE-101.02	FENESTRATED, 40CM



SILVERSTEIN BREAST DISSECTOR

Item Code	Description
IM-BRE-102.01	14" (356 MM) LENGTH

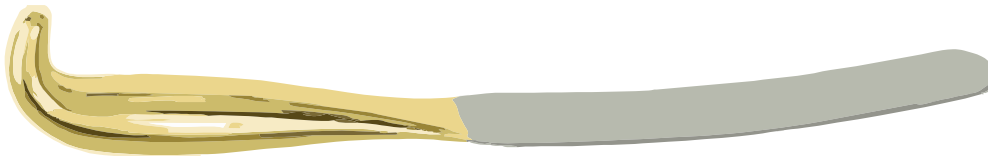

SPATULA BREAST RETRACTOR / DISSECTOR

Item Code	Description
IM-BRE-103.01	SERRATED, 12½", SEMI MALLEABLE



LOCKWOOD Underminer Dissector

Item Code	Description
IM-BRE-104.01	38cm, Length, 3cm Lift

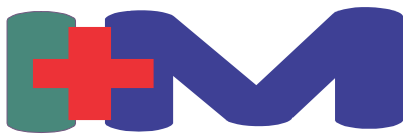

BREAST RETRACTORS & ELEVATORS



MCINNIS POLYCURETTE BREAST INSTRUMENT

Item Code	Description
IM-BRE-105.01	1 1/4" (300 MM) WIDTH, 12 1/2" (318 MM) LENGTH



JACOBS TRANSAXILLARY DISSECTOR

Item Code	Description
IM-BRE-106.01	CURVED SHAFT CHISEL EDGE 17" (432 mm) WIDTH 1/2" (13mm)



WIESLANDER TRANSAXILLARY BREAST DISSECTOR

Item Code	Description
IM-BRE-107.01	LENGTH 18 1/8" (460mm) WIDTH 1" (25mm)
IM-BRE-108.02	LENGTH 17" (432mm) WIDTH 1-3/8" (35mm)



REYNOLDS TRANSAXILLARY BREAST DISSECTOR

Item Code	Description
IM-BRE-109.01	15 3/4" (400mm) 1 1/2" (38mm)



TROCAR BREAST TUBE

Item Code	Description
IM-BRE-110.01	14" (356 MM), LARGE, 17.3 MM ID, 19.0 MM OD
IM-BRE-111.02	13 1/2" (343MM), SMALL, 14 MM ID, 16 MM OD

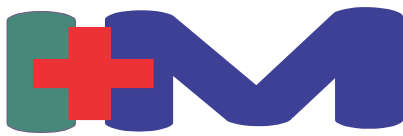

BREAST RETRACTORS & ELEVATORS



SOLZ ATRAUMATIC BREAST DISSECTOR

Item Code	Description
IM-BRE-112.01	34CM
IM-BRE-113.02	37CM



SOLZ BREAST HOOK DISSECTOR

Item Code	Description
IM-BRE-114.01	SET OF 2, LEFT AND RIGHT, 36CM



BREAST SPATULA

Item Code	Description
IM-BRE-116.01	WITH HANDLE 31.5 CM, 25MM X 18 CM BLADE, SERRATED TIP, SEMI MALLABLE

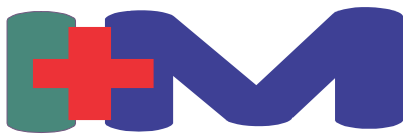

BREAST RETRACTORS & ELEVATORS



Breast And Facial Spreader

Item Code	Description
IM-BRE-117.01	LARGE, 11½" (292 MM) LENGTH, 5¾" (146 MM) BLADE
IM-BRE-118.02	SMALL, 8¾" (222 MM) LENGTH, 3¼" (83 MM) BLADE



ICONOCLAST

Item Code	Description
IM-BRE-119.01	LARGE, 11½" (292 MM) LENGTH, 5¾" (146 MM) BLADE
IM-BRE-120.02	SMALL, 8¾" (222 MM) LENGTH, 3¼" (83 MM) BLADE

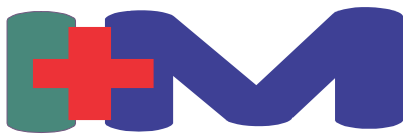

BREAST RETRACTORS & ELEVATORS

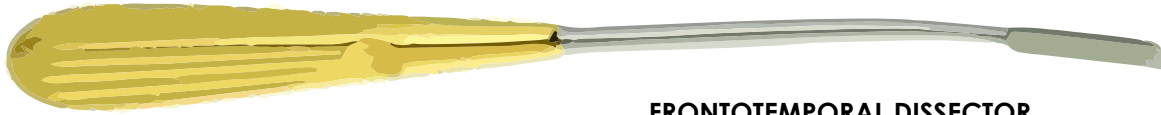

FRONTOTEMPORAL DISSECTOR

Item Code	Description
IM-BRE-121.01	9" (22.5 CM), 5MM TIP, SLIGHTLY CURVED
IM-BRE-122.02	9" (23 CM), 7MM TIP, SLIGHTLY CURVED
IM-BRE-123.03	9" (23 CM), 10MM TIP, SLIGHTLY CURVED

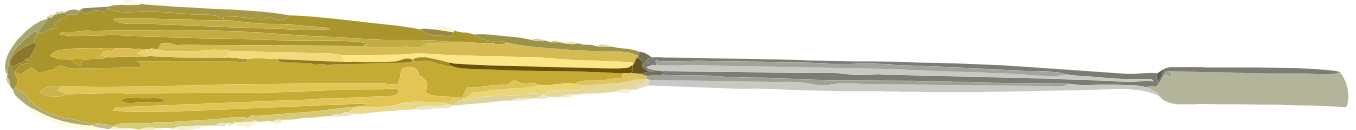

FLAP DISSECTOR

Item Code	Description
IM-BRE-124.0	19½" (23.5 CM), 5MM TIP, STRAIGHT



TEMPORAL T DISSECTOR

Item Code	Description
IM-BRE-125.01	9½" (23.5 CM), 12MM TIP, STRAIGHT



FRONTOGLABELLAR DISSECTOR

Item Code	Description
IM-BRE-126.01	10½" (26.5 CM), 7MM TIP, S SHAPED

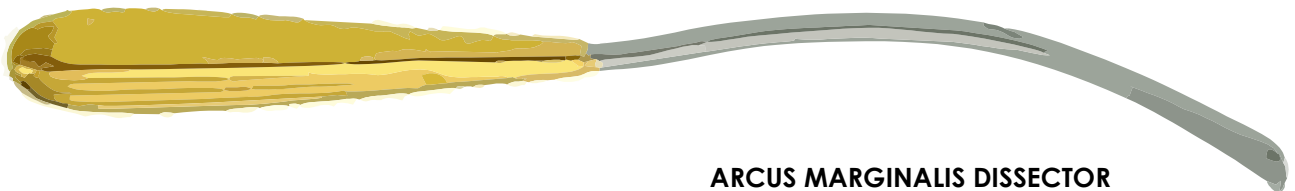

ARCUS MARGINALIS DISSECTOR

Item Code	Description
IM-BRE-127.01	9 3/4" (24 CM), 10MM TIP, S SHAPED

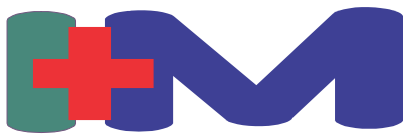

MEASURING AND MARKING INSTRUMENTS



FREEMAN AREOLA MARKER

- Ø = 34mm X 36mm **IM-MM-90.34**
- Ø = 38mm X 42mm **IM-MM-91.38**
- Ø = 42mm X 45mm **IM-MM-92.42**
- Ø = 45mm X 50mm **IM-MM-93.45**



**GROSSMANN AREOLA MARKER
FOUR-RING AREOLA MARKER**

Aluminium Anodized

IM-MM-94.00

Ø = 40 mm / Ø = 4 mm / Ø = 48 mm / 52mm



FREEMAN AREOLA MARKER/Cutter

- Ø = 34 mm **IM-MM-94.34**
- Ø = 36 mm **IM-MM-95.36**
- Ø = 38 mm **IM-MM-96.38**
- Ø = 42 mm **IM-MM-97.42**
- Ø = 45 mm **IM-MM-98.45**
- Ø = 50 mm **IM-MM-99.50**



SOLZ AREOLA MARKER

- Ø = 36 mm **IM-MM-10.36**
- Ø = 40 mm **IM-MM-11.40**
- Ø = 42 mm **IM-MM-12.42**
- Ø = 45 mm **IM-MM-13.45**

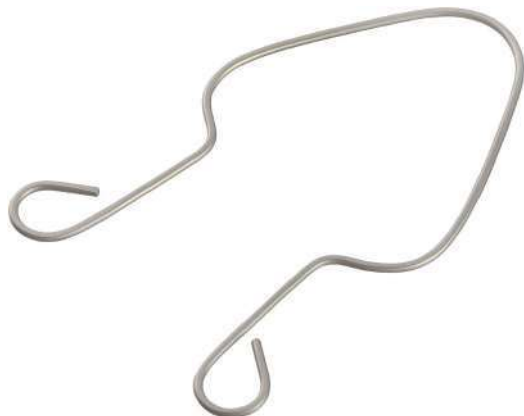

IM-MM-15.14
14cm / 5 1/2" **Small**

IM-MM-16.16
16cm / 6 1/4" **Large**



MCKISSOCK KEYHOLE PATTERN

- Ø = 38 mm **IM-MM-17.38**
- Ø = 42 mm **IM-MM-18.42**
- Ø = 45 mm **IM-MM-19.45**

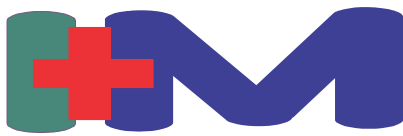

MEASURING AND MARKING INSTRUMENTS



Walden Breast Marker 70mm, with 7cm

IM-MM-20.00

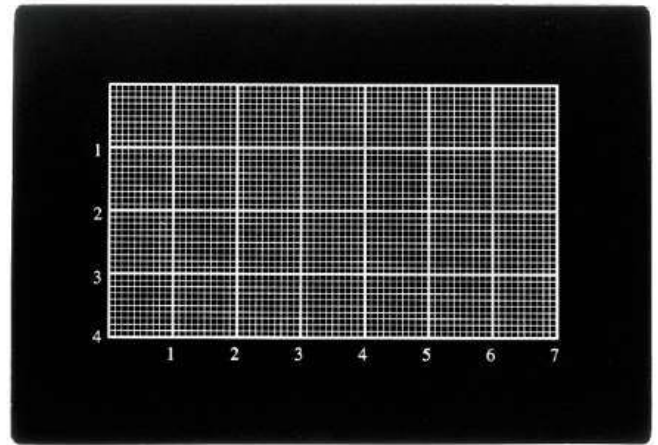

Sheen Grid Reverse, Autoclavable

IM-MM-21.00



Castroviejo Caliper, 7cm
Measuring Range 20mm

IM-MM-22.00



Castroviejo Caliper, 9cm
Measuring Range 40mm

IM-MM-23.00

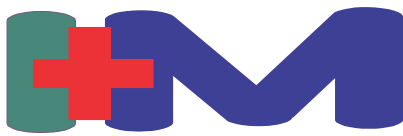

MEASURING AND MARKING INSTRUMENTS



CASTROVIEJO EPKER
IM-MM-24.42
18 cm / 7 1/8"

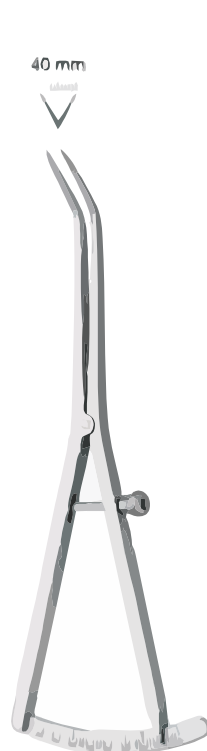

CASTROVIEJO EPKER
IM-MM-25.43
18 cm / 7 1/8"



GUBISCH
IM-MM-26.02
Pen

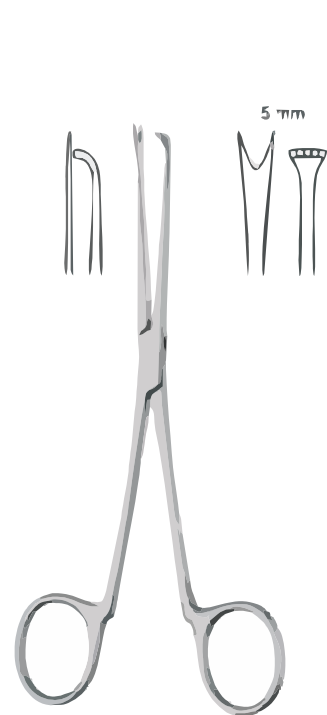

PITANGUY
IM-MM-27.30
16 cm / 6 1/4"



MARTEN FLAP MARKER
IM-MM-28.14
14.5 cm / 5 3/4"



D ASSUMPCAO ABDOMINAL FLAP
MARKER
IM-MM-29.16
10mm Width, 16cm



DeMartel Scalp Flap Demarcator
IM-MM-30.30
15 cm

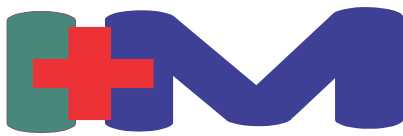

IBRAHIM MEDS

WE SERVE HUMANITY WITH EXCELLENCE

MEASURING AND MARKING INSTRUMENTS

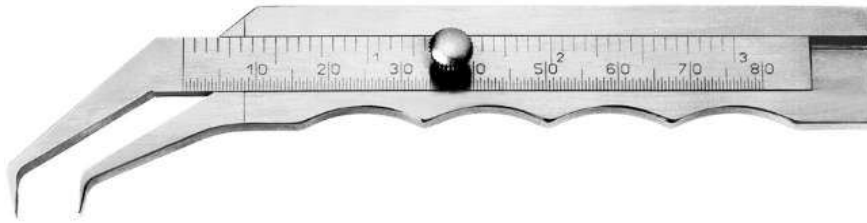

Thorpe Caliper, 80mm Measuring Range, 11cm

IM-MM-21-31.30

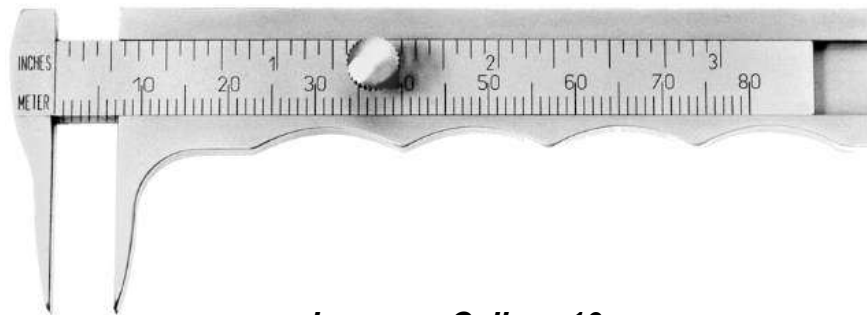

Jameson Caliper 10cm

IM-MM-32.30



Ruler, Stainless Steel Graduation in Millimeter and Inches

IM-MM-33-15

15 cm / 6"

IM-MM-34-20

20 cm / 8"

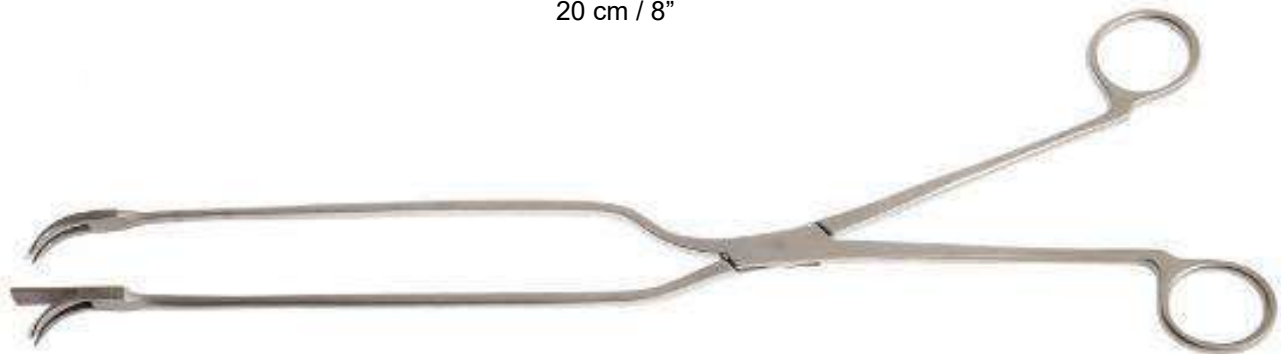

LOCKWOOD ABDOMINAL FLAP DEMARCATOR

IM-MM-35.32

11mm Width, 32cm

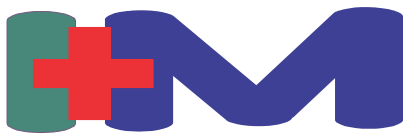

MEASURING AND MARKING INSTRUMENTS



IM-MM-36-10
24 cm / 9½"



JOSEPH
IM-MM-37-47
17 cm / 6¾"



JOSEPH

IM-MM-30.12
12 cm / 4¾"

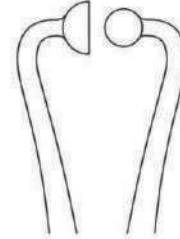

IM-MM-30.14
14.5 cm / 5¾"

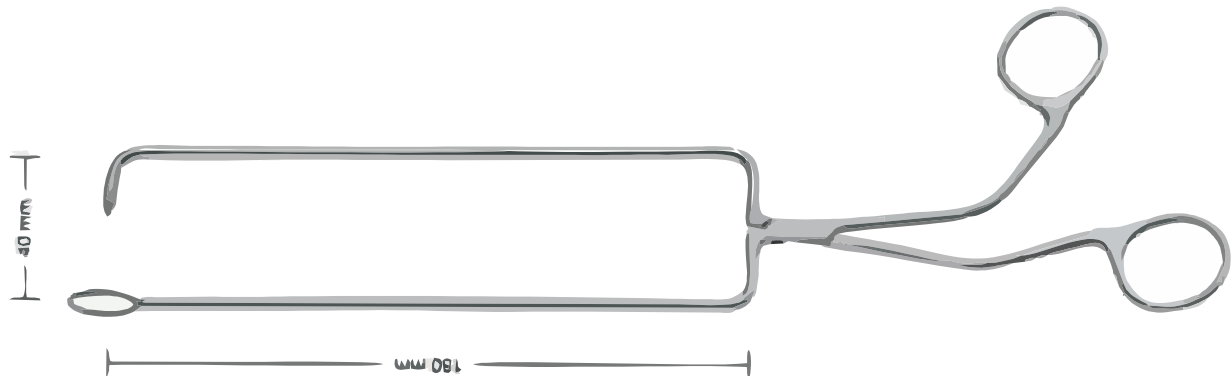
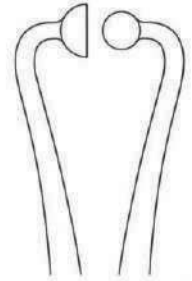

SOLZ Navel Marker

IM-MM-40.53

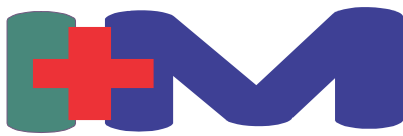

IBRAHIM MEDS

WE SERVE HUMANITY WITH EXCELLENCE

SUCTION TUBES

6 mm



10 mm



6 mm



8 mm



POOLE
IM-MM-54.18 – ø 6 mm
IM-MM-55.30 – ø 10 mm
 22 cm / 8 3/4"

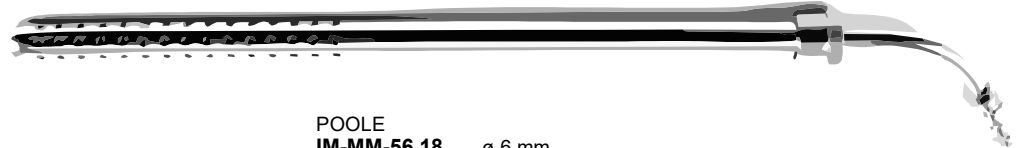

POOLE
IM-MM-56.18 – ø 6 mm
IM-MM-57.23 – ø 8 mm
 22 cm / 8 3/4"

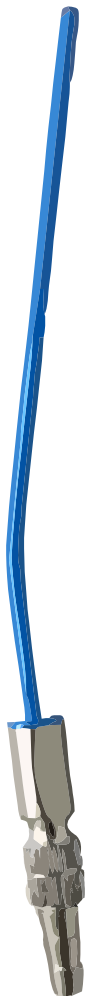

IM-MM-58.01 – 10 Fr (3.3mm)
IM-MM-59.02 – 12 Fr (4.0mm)

*Frazier Suction Tube Insulated,
 With Finger Cut Off, Angled*



YANKAUER
IM-MM-60.00
 28 cm / 11"



FRAZIER

	12.5 cm / 5"	18 cm / 7"		12.5 cm / 5"	18 cm / 7"
IM-MM-61.06	PST-65.52	Charr 6	IM-MM-69.36	IM-MM-73.86	
IM-MM-62.08	PST-66.58	Charr 8	IM-MM-70.38	IM-MM-74.88	
IM-MM-63.10	PST-67.60	Charr 10	IM-MM-71.40	IM-MM-75.90	
IM-MM-64.12	PST-68.62	Charr 12	IM-MM-72.42	IM-MM-76.92	

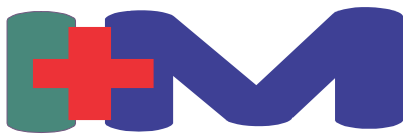

SCISSORS



KNAPP

standard
supercut

12 cm / 4¾"
IM-S-66.32
IM-S-67.132



12 cm / 4¾"
IM-S-68.32
IM-S-69.132



12 cm / 4¾"
IM-S-70.52



12 cm / 4¾"
IM-S-71.52



KNAPP

10 cm / 4"
standard

IM-S-72.70



10 cm / 4"
IM-S-73.70



standard

9.5cm / 5"
IM-S-74.90



standard
supercut
TC

12.5cm / 5"
IM-S-75.42
IM-S-76.142
IM-S-77.62



12.5cm / 5"
IM-S-78.43
IM-S-79.143
IM-S-80.63



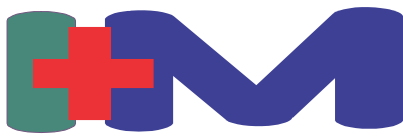

SCISSORS



STEVENS

standard

10 cm / 4"

IM-S-21-81.70



10 cm / 4"

IM-S-21-82.71



10 cm / 4"

IM-S-21-83.70



10 cm / 4"

IM-S-21-84.71



STEVENS

standard
supercut

11.5 cm / 4½"

IM-S-85.12
IM-S-86.112



11.5 cm / 4½"

IM-S-87.13
IM-S-88.113



STEVENS

standard
supercut

13 cm / 5 1/8"

IM-S-89.15
IM-S-90.115

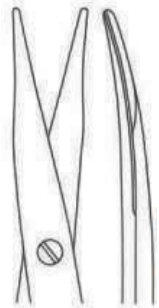

LEXER BABY

10 cm / 4"
standard
TC

IM-S-91.10
IM-S-92.60



10 cm / 4"
IM-S-93.10
IM-S-94.61



KNAPP

standard
supercut
TC

12.5cm / 5"
IM-S-95.12
IM-S-96.112
IM-S-97.62



12.5cm / 5"
IM-S-98.12
IM-S-99.112
IM-S-100.62

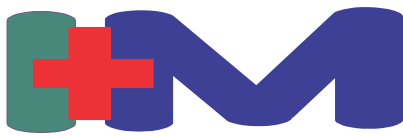

IBRAHIM MEDS

WE SERVE HUMANITY WITH EXCELLENCE

SCISSORS



KELLY

standard
supercut
TC
supercut plus



16 cm / 6 1/4"
IM-S-21-101.16
IM-S-21-102.116
IM-S-21-103.66
IM-S-21-104.166



16 cm / 6 1/4"
IM-S-21-105.16
IM-S-21-106.116
IM-S-21-107.66
IM-S-21-108.166



BRUSER KELLY



16 cm / 6 1/4"
supercut **IM-S-21-109.116**



16 cm / 6 1/4"
IM-S-21-110.116



SIEGERT

standard
TC



11.5cm / 4 1/2"
IM-S-111.131
IM-S-112.61



11.5cm / 4 1/2"
IM-S-113.132
IM-S-114.62

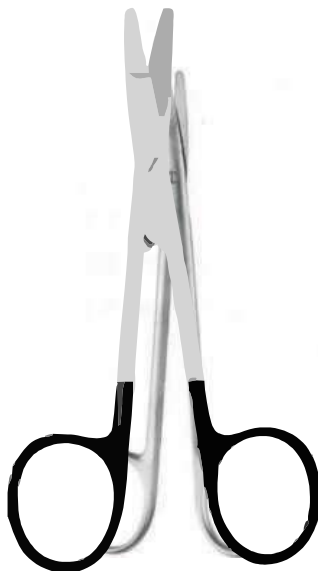

RAGNELL (KILNER)

standard
supercut
TC
supercut plus

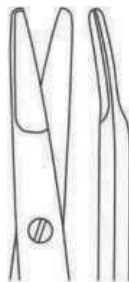

13 cm / 5 1/8"
IM-S-115.13
IM-S-116.113
IM-S-117.63
IM-S-118.163

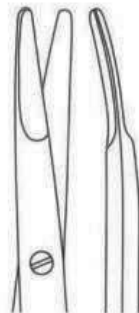

15 cm / 6"
IM-S-119.15
IM-S-120.115
IM-S-121.65
IM-S-122.165

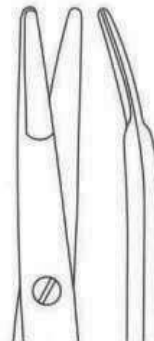

18 cm / 7 1/8"
IM-S-123.18
IM-S-124.118
IM-S-125.68
IM-S-126.168

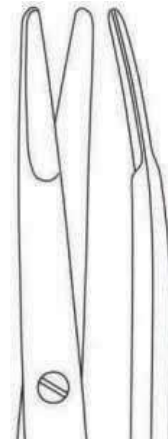

20 cm / 8"
IM-S-127.20

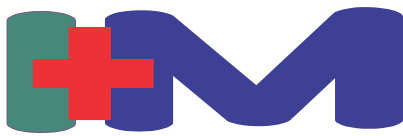

SCISSORS



GREENBERG PAR

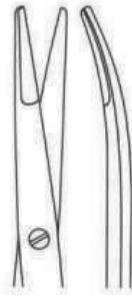

supercut
supercut plus

11.5 cm / 4 1/2"
IM-S-128.122
IM-S-129.122



standard
supercut



11 cm / 4 3/8"
IM-S-130.11
IM-S-131.111



11 cm / 4 3/8"
IM-S-132.12
IM-S-133.112



JABELEY



standard
supercut

13 cm / 5 1/8"
IM-S-134.13
IM-S-135.113



13 cm / 5 1/8"
IM-S-136.14
IM-S-137.114



JOSEPH



standard
supercut

15cm / 6"
IM-S-138.14
IM-S-139.114



15cm / 6"
IM-S-140.14
IM-S-141.114

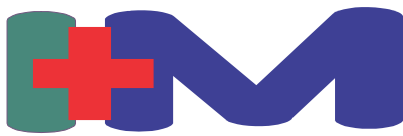

SCISSORS



JAMESON

standard



15cm / 6"
IM-S-142.117



18 cm / 7 1/8"
IM-S-143.118



REYNOLDS (JAMESON)

standard



12 cm / 4 3/4"
IM-S-144.12
blunt



14 cm / 5 1/2"
IM-S-145.14
blunt



16 cm / 6 1/4"
IM-S-146.16
blunt



18 cm / 7 1/8"
IM-S-147.18
blunt



REYNOLDS (JAMESON)

standard
supercut



12 cm / 4 3/4"
IM-S-21-148.12
IM-S-21-149.112
blunt



14 cm / 5 1/2"
IM-S-21-150.14



16 cm / 6 1/4"
IM-S-21-151.16
IM-S-21-152.116
blunt





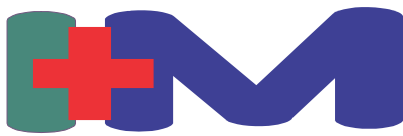

18 cm / 7 1/8"
IM-S-21-153.18
IM-S-21-154.118
blunt





SCISSORS





					
supercut	14 cm / 5½" IM-S-155.134	14 cm / 5½" IM-S-156.134	14 cm / 5½" IM-S-157.144	14 cm / 5½" IM-S-158.144	

PECK JOSEPH





"slim"

			
standard	14 cm / 5½" IM-S-159.14	18 cm / 7 1/8" IM-S-163.18	20 cm / 8" IM-S-164.20
supercut	IM-S-160.114		
TC	IM-S-161.64		
supercut plus	IM-S-162.164		



"slim"

			
standard	14 cm / 5½" IM-S-165.14	18 cm / 7 1/8" IM-S-169.18	20 cm / 8" IM-S-171.20
supercut	IM-S-166.114	IM-S-170.118	
TC	IM-S-167.64		
supercut plus	IM-S-168.164		

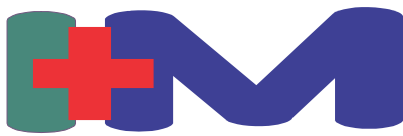

SCISSORS



FANOUS

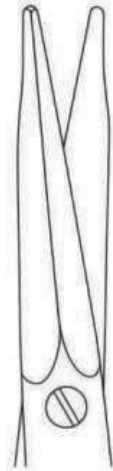

supercut
16.5 cm / 6½"
IM-S-172.116



16.5 cm / 6½"
IM-S-173.126

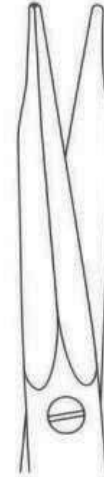

16.5 cm / 6½"
IM-S-174.120

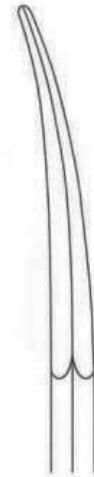

16.5 cm / 6½"
IM-S-175.130



GORNEY

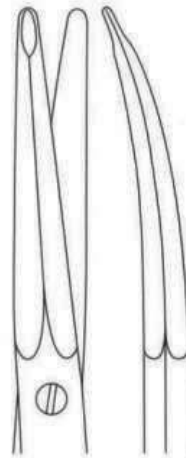

GORNEY

supercut
17cm / 6¾"
IM-S-176.127
TC
IM-S-177.67

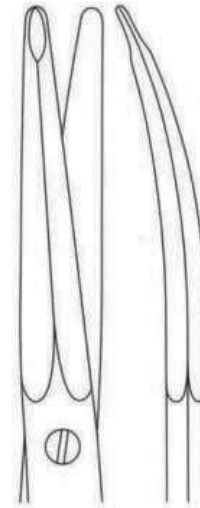

19 cm / 7½"
IM-S-178.129
IM-S-179.69

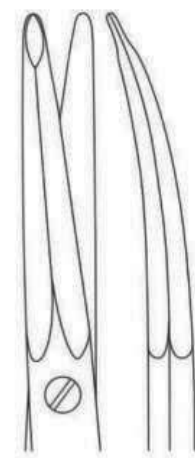

23 cm / 9"
IM-S-180.133
IM-S-181.73

GORNEY-FREEMAN

supercut
17cm / 6¾"
IM-S-182.117
TC
IM-S-183.37

19 cm / 7½"
IM-S-184.119
IM-S-185.39

23 cm / 9"
IM-S-186.123
IM-S-187.43

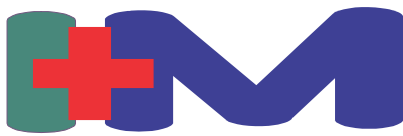

SCISSORS



GORNEY-FREEMAN

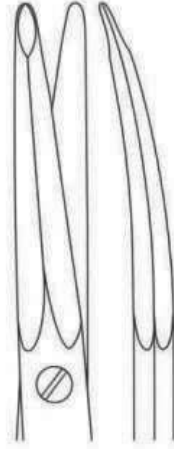

supercut
TC
23 cm / 9"
IM-S-188.152
IM-S-189.72



GORNEY-FREEMAN

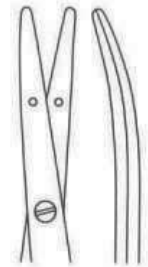

standard
12 cm / 4 3/4"
IM-S-190.01



KAYE

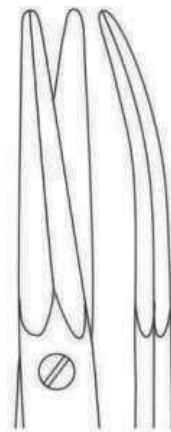

supercut
TC
15 cm / 6"
IM-S-191.115

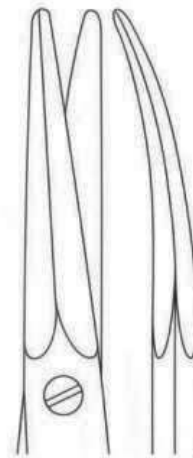

17cm / 6 3/4"
IM-S-192.117
IM-S-193.37

IM-

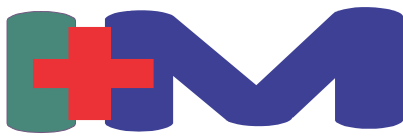

SCISSORS



KAYE

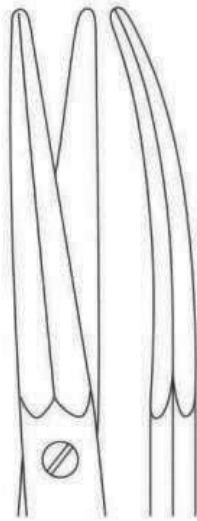

supercut
TC
19 cm / 7½"
IM-S-194.119
IM-S-195.39

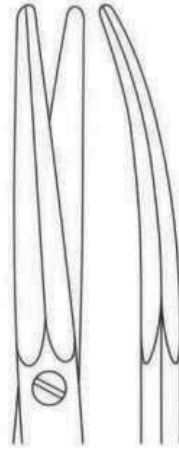

23 cm / 9"
IM-S-196.123
IM-S-197.43



KAYE

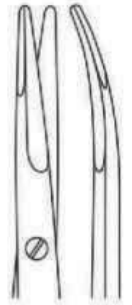

supercut
11.5 cm / 4½"
IM-S-198.132



SOLZ

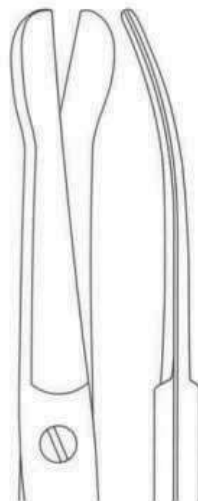

supercut
20 cm / 8"
IM-S-199.220



SOLZ

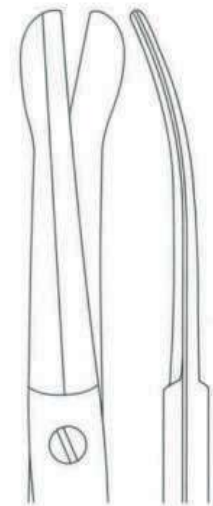

supercut
20 cm / 8"
IM-S-200.230

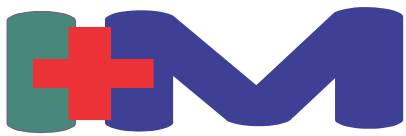

SCISSORS



O'BRIEN

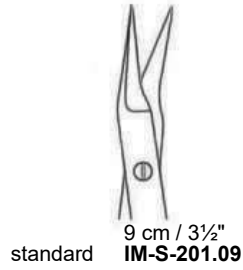

standard

9 cm / 3½"
IM-S-201.09

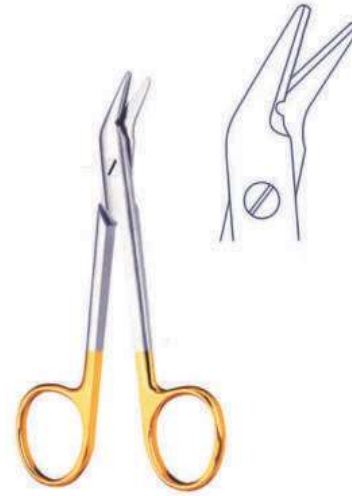

UNIVERSAL
IM-S-202.12
12 cm / 4¾"



RHINOPLASTY FINE SCISSORS

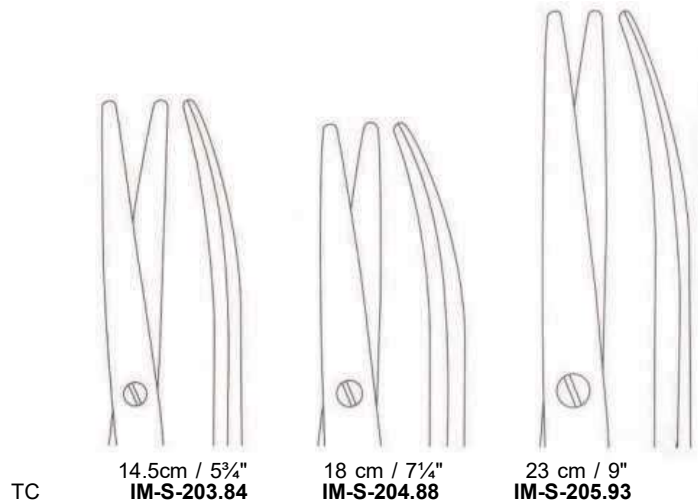

TC

14.5cm / 5¾"
IM-S-203.84

18 cm / 7¼"
IM-S-204.88

23 cm / 9"
IM-S-205.93

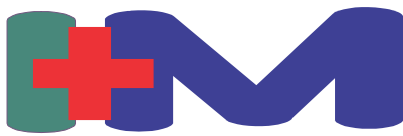

SCISSORS



FOMON

standard
supercut
supercut plus



13 cm / 5 1/8"
IM-S-206.13
IM-S-207.113
IM-S-208.163

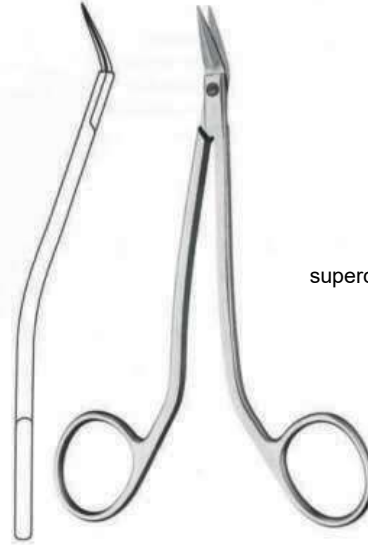

WALTER

supercut

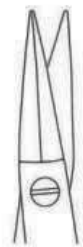

14 cm / 5 1/2"
IM-S-21-209.14

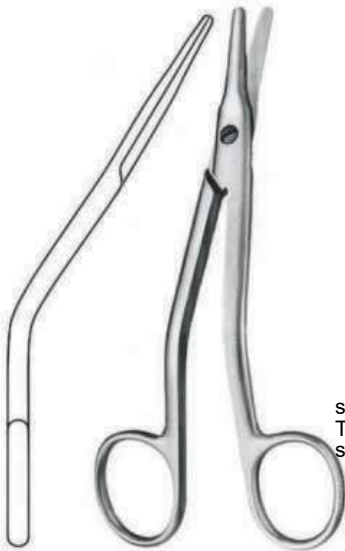

WALTER COTTLE

supercut
TC
supercut plus

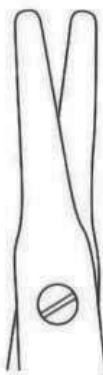

16 cm / 6 1/4"
IM-S-210.16
IM-S-211.77
IM-S-212.177

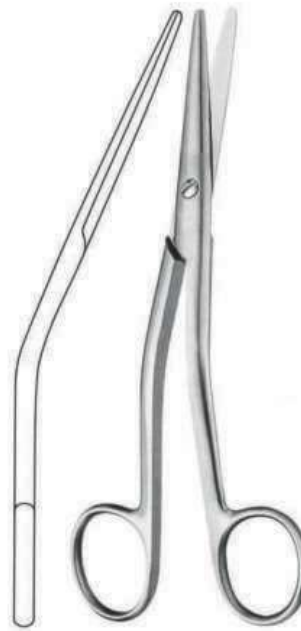

COTTLE

standard
supercut
TC
supercut plus

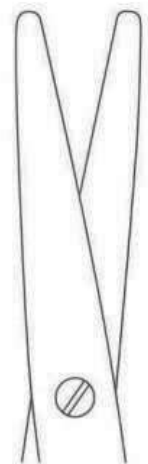

16cm / 6 1/4"
IM-S-213.16
IM-S-214.116
IM-S-215.36
IM-S-216.136

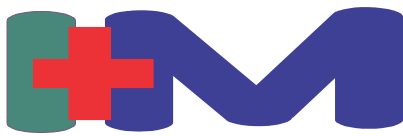

SCISSORS



GIUNTA

TC

13.5 cm / 5 3/8"
IM-S-217.63



CONVERSE

standard

13.5 cm / 5 3/8"
IM-S-218.13



COTTLE MASING

10 cm / 4"
standard

IM-S-219.10



10 cm / 4"
IM-S-220.10



COTTLE

standard

11.5 cm / 4 3/4"
IM-S-221.12

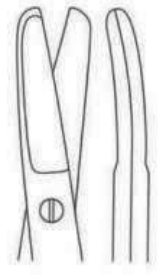

CINELLI

standard

11 cm / 4 3/8"
IM-S-222.11

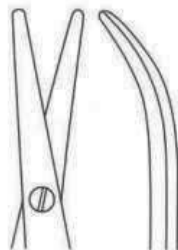

FOMON

standard

12.5 cm / 5"
IM-S-223.43

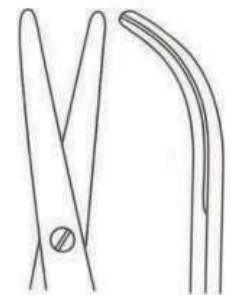

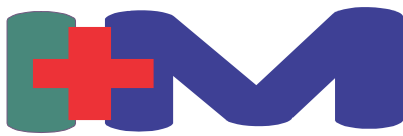

SCISSORS



DEAN

standard
supercut

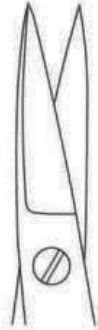

17 cm / 6 3/4"
IM-S-224.17
IM-S-225.117



HEYMANN

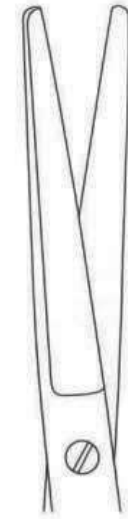

standard 20 cm / 8"
IM-S-226.20



HEYMANN

standard
supercut

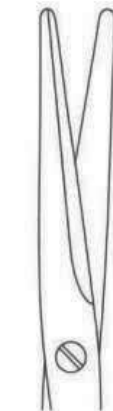

17 cm / 6 3/4"
IM-S-227.17

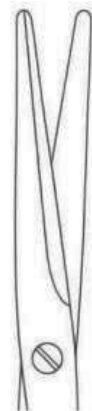

17 cm / 6 3/4"
IM-S-228.21



18 cm / 7 1/8"
IM-S-229.122

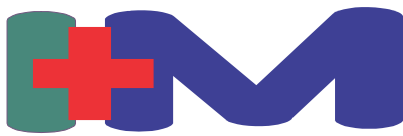

SCISSORS



FOX

standard
supercut
TC
supercut plus



13 cm / 5 1/8"
IM-S-230.13
IM-S-231.113
IM-S-232.63
IM-S-233.163



13 cm / 5 1/8"
IM-S-234.13
IM-S-235.113
IM-S-236.63
IM-S-237.163



SPENCER

standard
TC

9 cm / 3 1/2"
IM-S-238.09

10.5 cm / 4 1/8"
IM-S-239.10
IM-S-240.60

12 cm / 4 3/4"
IM-S-241.12
IM-S-242.62



LITTAUER

standard

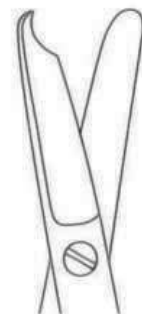

13 cm / 5 1/8"
IM-S-243.13



KELLY

standard



15 cm / 6"
IM-S-244.35

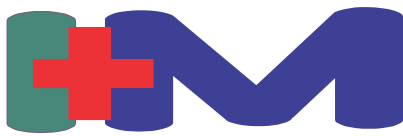

SCISSORS



MCINDOE

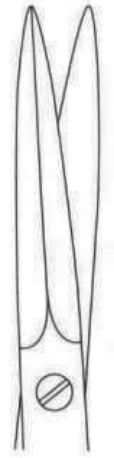

standard
19 cm / 7½"
IM-S-245.18



AUFRICHT

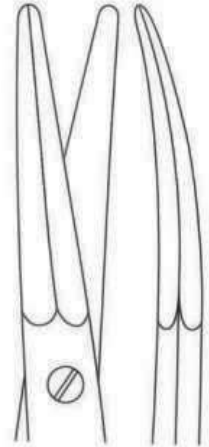

standard
supercut
TC
supercut plus
14 cm / 5½"
IM-S-246.34
IM-S-247.134
IM-S-248.64
IM-S-249.164



FOMON

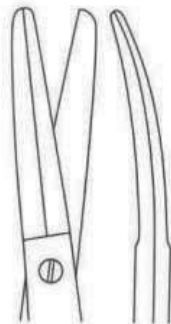

standard
12.5 cm / 5"
IM-S-250.43



FANOUS

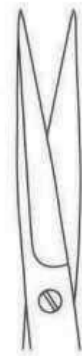

standard
supercut
13 cm / 5 1/8"
IM-S-251.14
IM-S-252.114

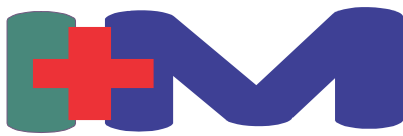

SCISSORS



COTTLE
IM-S-253.19
18 cm / 7 1/8"



CAPLAN
IM-S-254.20
20 cm / 8"



OBWEGESER

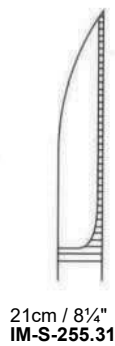

21cm / 8 1/4"
IM-S-255.31

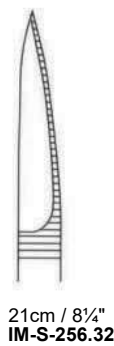

21cm / 8 1/4"
IM-S-256.32

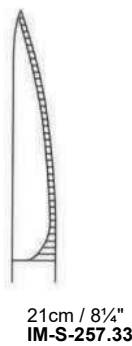

21cm / 8 1/4"
IM-S-257.33

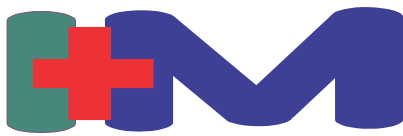

SCISSORS



MAYO

standard
supercut
TC
supercut plus

14 cm / 5½"
IM-S-258.14
IM-S-259.114
IM-S-260.64
IM-S-261.164

14 cm / 5½"
IM-S-262.14
IM-S-263.114
IM-S-264.64
IM-S-265.164

17 cm / 6¾"
IM-S-266.17
IM-S-267.117
IM-S-268.67
IM-S-269.167

17 cm / 6¾"
IM-S-270.17
IM-S-271.117
IM-S-272.67
IM-S-273.167



MAYO STILLE

standard
supercut
TC
supercut plus

16 cm / 6¼"
IM-S-274.15
IM-S-275.115
IM-S-276.65
IM-S-277.165

16 cm / 6¼"
IM-S-278.17
IM-S-279.117
IM-S-280.67
IM-S-281.167

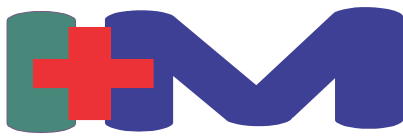

SCISSORS



MAYO LEXER

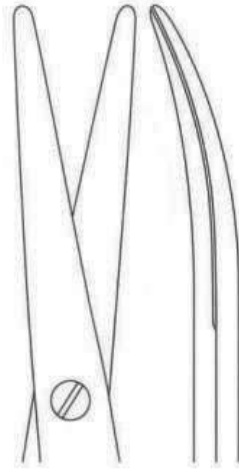

supercut **16.5 cm / 6½"**
 TC **IM-S-282.187**
 supercut plus **IM-S-283.97**
IM-S-284.197



LEXER

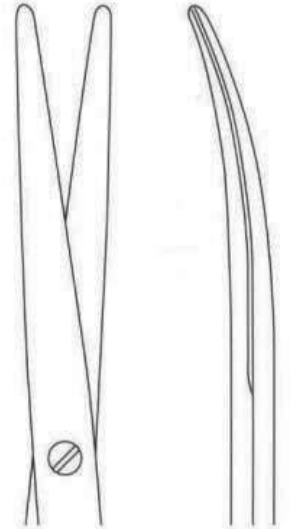

standard **16 cm / 6¼"**
 supercut **IM-S-285.86**
 TC **IM-S-286.116**
 supercut plus **IM-S-287.96**
IM-S-288.196

16 cm / 6¼"
IM-S-289.17
IM-S-290.117
IM-S-291.96
IM-S-292.16



BABY METZENBAUM

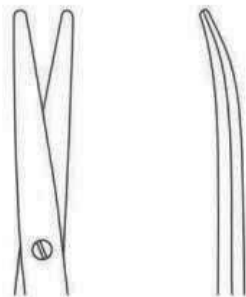

standard **11.5 cm / 4½"**
 supercut **IM-S-296.11**
 TC **IM-S-297.111**
 supercut plus **IM-S-298.61**
IM-S-299.161

11.5 cm / 4½"
IM-S-300.11
IM-S-301.111
IM-S-302.61
IM-S-303.161



IM-S-293.30
16 cm

IM-S-294.30
18 cm

IM-S-295.30
23 cm

Trepstat Facial Flap Dissector Scissors
T.C. insert

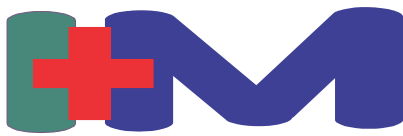

SCISSORS



METZENBAUM

standard
supercut
TC
supercut plus



14 cm / 5½"
IM-S-304.14
IM-S-305.114
IM-S-306.64
IM-S-307.164



18 cm / 7 1/8"
IM-S-308.18
IM-S-309.118
IM-S-310.68
IM-S-311.168

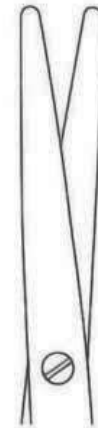

20 cm / 8"
IM-S-312.20
IM-S-313.120
IM-S-314.70
IM-S-315.170



BABY METZENBAUM

standard
supercut
TC
supercut plus

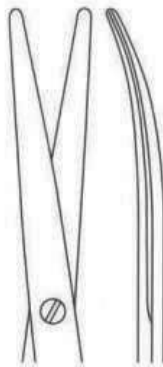

14 cm / 5½"
IM-S-316.14
IM-S-317.114
IM-S-318.64
IM-S-319.164

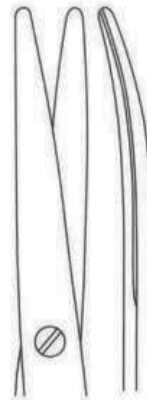

15 cm / 6"
IM-S-320.15
IM-S-321.115
IM-S-322.68
IM-S-323.168

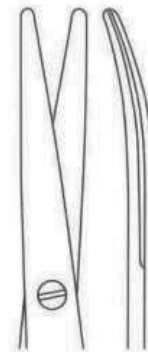

18 cm / 7 1/8"
IM-S-324.18
IM-S-325.118
IM-S-326.70
IM-S-327.170

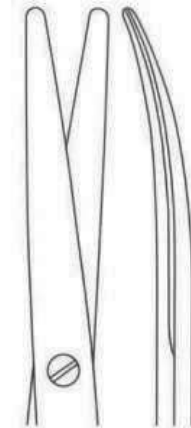

20 cm / 8"
IM-S-328.20
IM-S-329.120

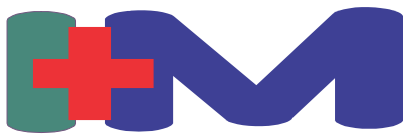

IBRAHIM MEDS

WE SERVE HUMANITY WITH EXCELLENCE

SCISSORS



MINI METZENBAUM



9 cm / 3 1/2"
supercut **IM-S-330.109**



9 cm / 3 1/2"
IM-S-331.109



NELSON METZENBAUM

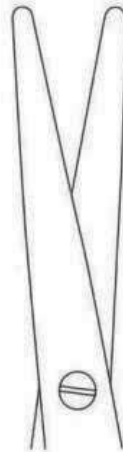

standard
supercut
TC
supercut plus

23 cm / 9"
IM-S-332.23
IM-S-333.123
IM-S-334.73
IM-S-335.173



26 cm / 10 1/4"
IM-S-336.26
IM-S-337.126

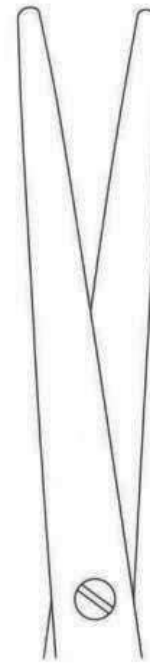

30 cm / 11 3/4"
IM-S-338.30
IM-S-339.130

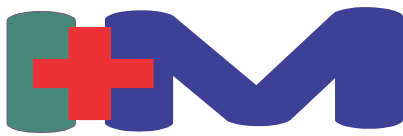

SCISSORS



NELSON METZENBAUM

standard
supercut
TC
supercut plus

23 cm / 9"
IM-S-340.23
IM-S-341.123
IM-S-342.73
IM-S-343.173

26 cm / 10¼"
IM-S-344.26
IM-S-345.126
IM-S-346.76
IM-S-347.176

30 cm / 11¾"
IM-S-348.30
IM-S-349.130
IM-S-350.80
IM-S-351.180



METZENBAUM slim

standard
supercut
TC
supercut plus

14 cm / 5½"
IM-S-352.14
IM-S-353.114
IM-S-354.64
IM-S-355.164

18 cm / 7 1/8"
IM-S-356.18
IM-S-357.118
IM-S-358.68
IM-S-359.168

20 cm / 8"
IM-S-360.20
IM-S-361.120
IM-S-362.70
IM-S-363.170

23 cm / 9"
IM-S-364.23
IM-S-365.123
IM-S-366.73
IM-S-367.173

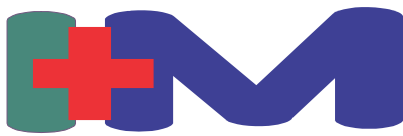

SCISSORS



METZENBAUM slim

standard
supercut
TC
supercut plus



14 cm / 5½"
IM-S-368.14
IM-S-369.114
IM-S-370.64
IM-S-371.164



18 cm / 7 1/8"
IM-S-372.18
IM-S-373.118
IM-S-374.68
IM-S-375.168



20 cm / 8"
IM-S-376.20
IM-S-377.120
IM-S-378.70
IM-S-379.170



23 cm / 9"
IM-S-380.23
IM-S-381.123
IM-S-382.73
IM-S-383.173



METZENBAUM slim

supercut

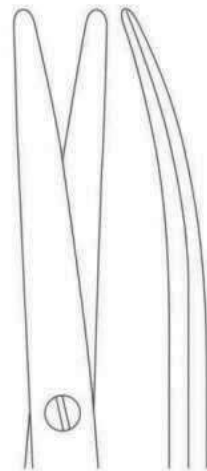

28.5 cm / 11¼"
IM-S-384.176

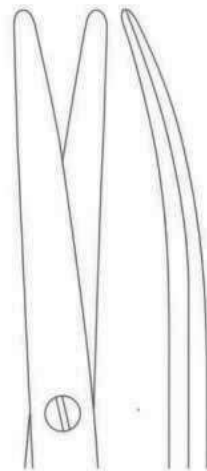

28.5 cm / 11¼"
IM-S-385.178



TOENNIS ADSON

standard
supercut
TC
suercut plus



18 cm / 7 1/8"
IM-S-386.18
IM-S-387.118
IM-S-388.68
IM-S-389.168

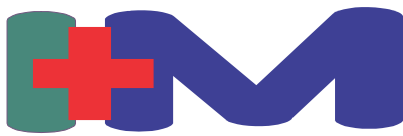

SCISSORS



METZENBAUM

supercut
TC
supercut plus

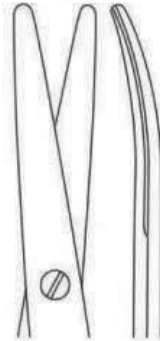

18 cm / 7 1/8"
IM-S-390.168
IM-S-391.78
IM-S-392.178

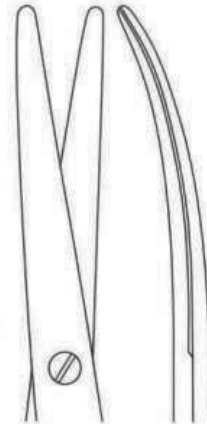

20 cm / 8"
IM-S-393.170
IM-S-394.80
IM-S-395.180

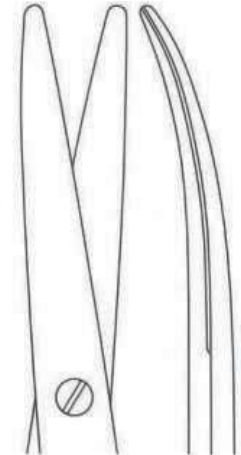

23 cm / 9"
IM-S-396.173
IM-S-397.83
IM-S-398.183



METZENBAUM FREEMAN

supercut

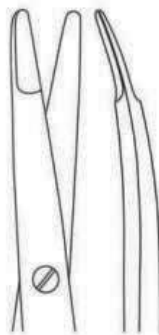

18 cm / 7 1/8"
IM-S-399.168

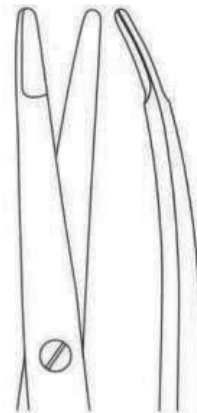

20 cm / 8"
IM-S-400.170

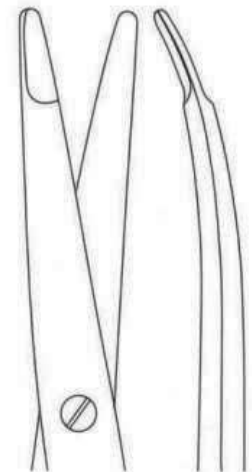

23 cm / 9"
IM-S-401.173

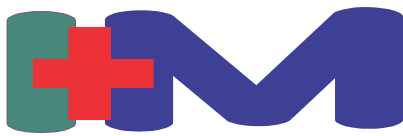

SCISSORS



standard

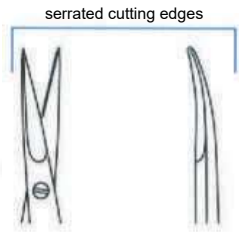

serrated cutting edges

15 cm / 6"
IM-S-402.22

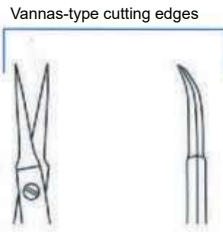

Vannas-type cutting edges

15 cm / 6"
IM-S-403.23

15 cm / 6"
IM-S-404.30

15 cm / 6"
IM-S-405.31

micro 2000



micro 2000



15 cm / 6"
standard
super-cut IM-S-406.20
IM-S-407.120



15 cm / 6"
IM-S-408.21
IM-S-409.121



standard
super-cut IM-S-410.74
IM-S-411.174



15 cm / 6"
IM-S-412.75



15 cm / 6"
IM-S-413.76

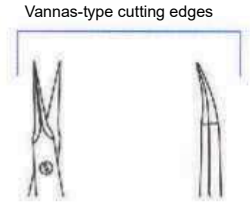

15 cm / 6"
IM-S-413.76



15 cm / 6"
IM-S-414.77

Round handle



standard



18 cm / 7 1/4"
IM-S-415.20



18 cm / 7 1/4"
IM-S-416.21



45°

18 cm / 7 1/4"
IM-S-417.25



45°

18 cm / 7 1/4"
IM-S-418.26



standard

23 cm / 9"
IM-S-419.02

Round handle



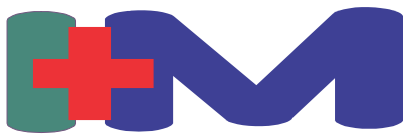

HEMOSTATIC FORCEPS



MICRO MOSQUITO FORCEPS

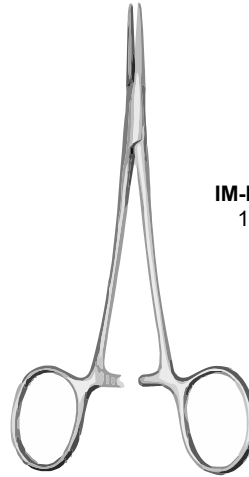
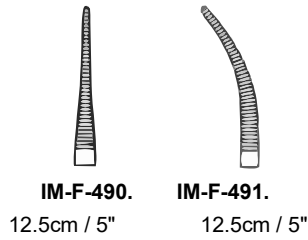

HALSTED MOSQUITO FORCEPS

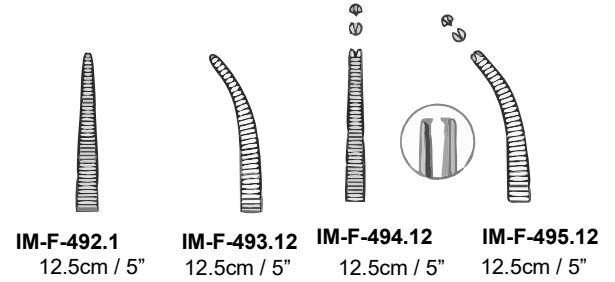

MICRO MOSQUITO FORCEPS

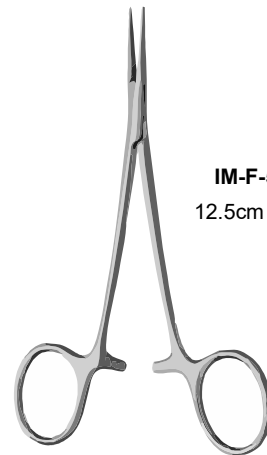
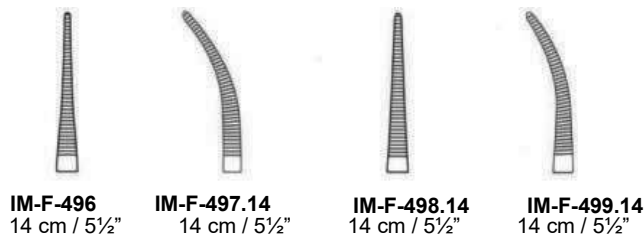

MICRO JACOBSON FORCEPS

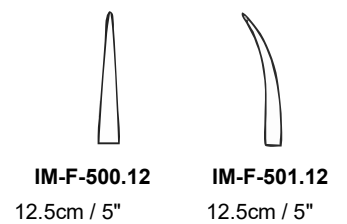

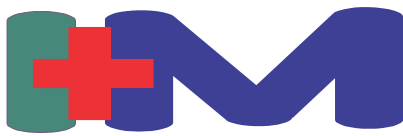

HEMOSTATIC FORCEPS



DIETHRICH



IM-F-504.08
4.5 cm / 1 3/4"



IM-F-505.12
5 cm / 2"



IM-F-506.16
5.5 cm / 2 1/8"



DIETHRICH

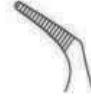

IM-F-507.28
4.5 cm / 1 3/4"

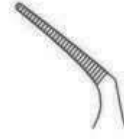

IM-F-508.32
5 cm / 2"



IM-F-509.36
5.5 cm / 2 1/8"

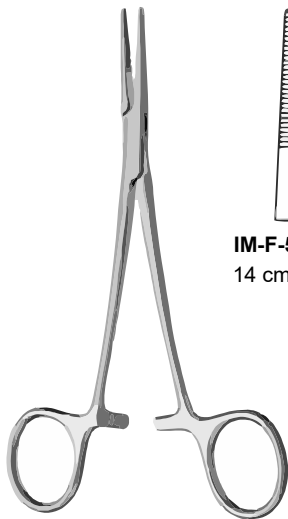

PROVIDENCE HOSPITAL FORCEPS, 14cm/5 1/2"



IM-F-510.14
14 cm / 5 1/2"



IM-F-511.14
14 cm / 5 1/2"



IM-F-512.14
14 cm / 5 1/2"



IM-F-513.14
14 cm / 5 1/2"

HEMOSTATIC FORCEPS

Atraumatic Serration



IM-F-514.12
12.5cm / 5"



IM-F-515.12
12.5cm / 5"

5 x 6



IM-F-521-16
15 cm / 6"

IM-F-522-19
19 cm / 7 1/2"

IM-F-523-23
23 cm / 9"

Allis Tissue Grasping Forceps

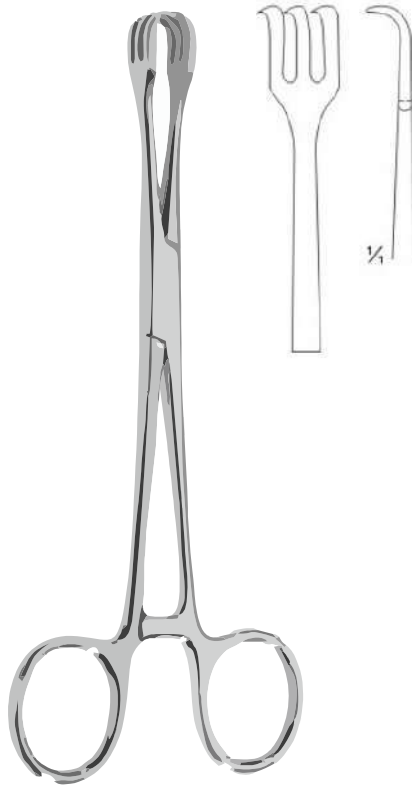

Lahey Traction Forceps, 16cm

IM-F-516.16



IM-F-524-14



IM-F-525-14

1 x 2



IM-F-526-14

1 x 2



IM-F-527-14

CRILE
14,0 cm, 5 1/2"

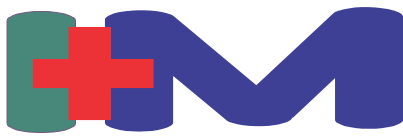

HEMOSTATIC FORCEPS



KELLY
14,0 cm, 5½"



IM-F-528-14



IM-F-528-114



Gross Dressing Forceps With Box & Lock, 20cm
IM-F-517.20



ROCHESTER-PEAN



14,0 cm, 5½"	IM-F-529-14	IM-F-537-14
16,0 cm, 6¼"	IM-F-530-16	IM-F-538-16
18,0 cm, 7"	IM-F-531-18	IM-F-539-18
20,0 cm, 8"	IM-F-532-20	IM-F-540-20
22,0 cm, 8⅝"	IM-F-533-22	IM-F-541-22
24,0 cm, 9½"	IM-F-534-24	IM-F-542-24
26,0 cm, 10¼"	IM-F-535-26	IM-F-543-26

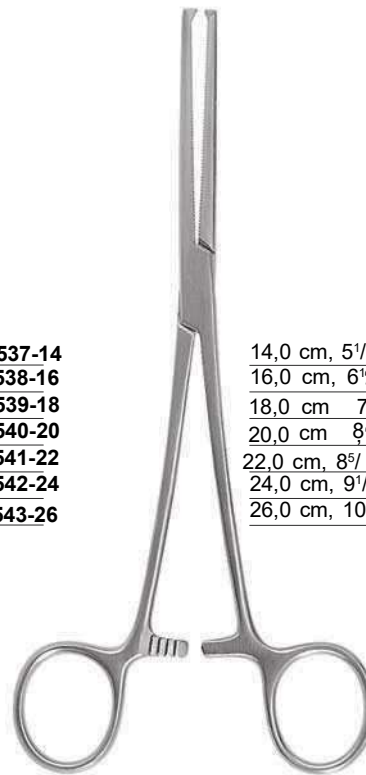

KOCHER-OCHSNER

1 x 2



1 x 2



14,0 cm, 5½"	IM-F-545-14	IM-F-552-14
16,0 cm, 6¼"	IM-F-546-15	IM-F-553-16
18,0 cm, 7"	IM-F-547-18	IM-F-554-18
20,0 cm, 8"	IM-F-548-20	IM-F-555-20
22,0 cm, 8⅝"	IM-F-549-22	IM-F-556-22
24,0 cm, 9½"	IM-F-550-24	IM-F-557-24
26,0 cm, 10¼"	IM-F-551-26	IM-F-558-26

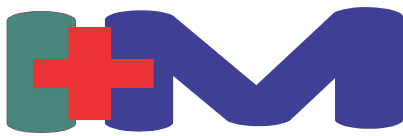

TOWEL CLAMPS



BACKHAUS

- 9,0 cm, 3 1/2" **IM-T-800-09**
- 11,0 cm, 4 3/8" **IM-T-801-11**
- 13,0 cm, 5" **IM-T-802-13**
- 15,0 cm, 6" **IM-T-803-15**

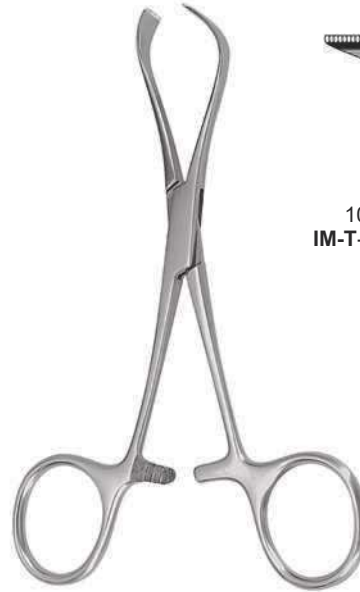

**Edna Lorna
Towel Clamp**

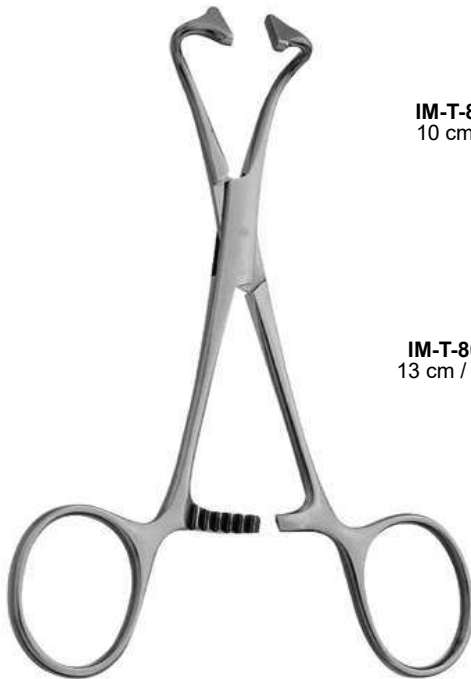
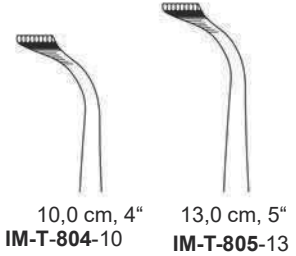

**Non-Perforating Towel
Clamp Forceps**

IM-T-806.10
10 cm / 4"

IM-T-807.13
13 cm / 5 1/8"



**Jones Towel Clamp,
Cross Action**

IM-T-808.09
10 cm / 4"

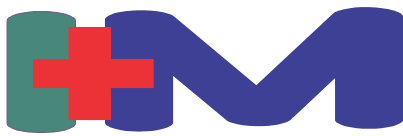

NEEDLE HOLDERS



COLLIER
IM-NH-09.13
13 cm / 5 1/8"

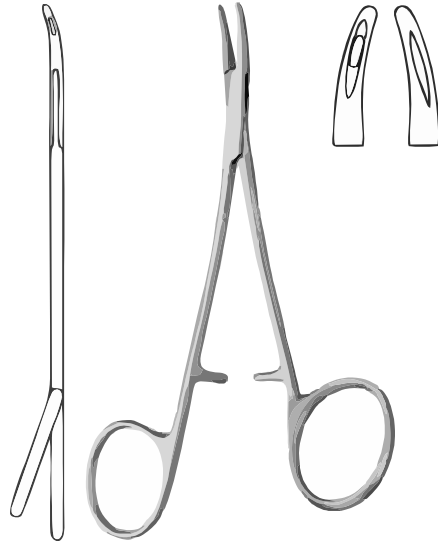

CONVERSE
IM-NH-10.15
15 cm / 6"

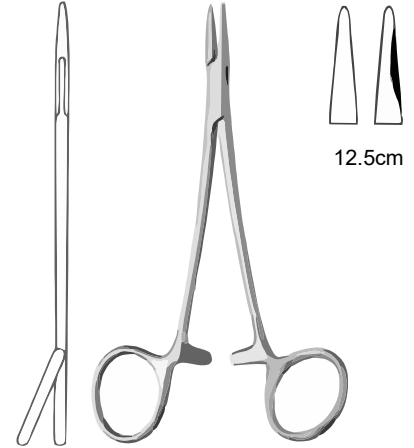

IM-NH-11.13



WRIGHT (DERF)
IM-NH-12.12



12.5cm



HALSEY
IM-NH-13.13



12.5cm

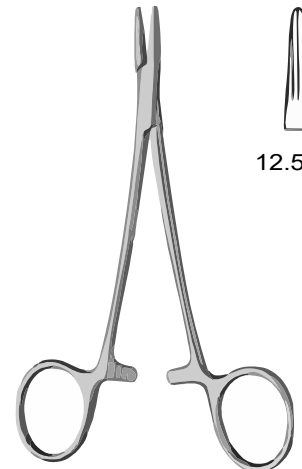

DERF CONVERSE
IM-NH-14.82



12.5cm

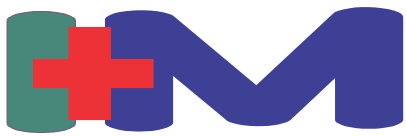

NEEDLE HOLDERS



CRILE WOOD



IM-NH-15.15
15 cm / 6"



IM-NH-16.18
18 cm / 7 1/8"



IM-NH-17.20
20 cm / 8"



IM-NH-18.23
23 cm / 9"

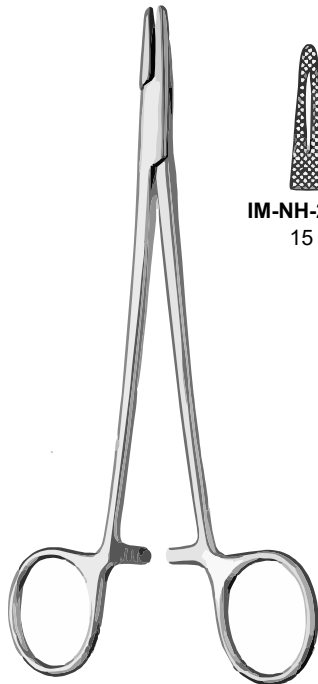

IM-NH-20.15
15 cm / 6"



IM-NH-20.18
18 cm / 7 1/8"



IM-NH-20.20
20 cm / 8"

IM-NH-20.24
24 cm / 9 1/2"

IM-NH-20.30
30 cm / 11 3/4"

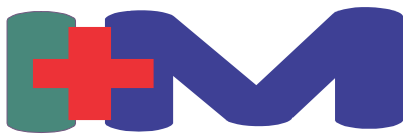

NEEDLE HOLDERS



SENNING
IM-NH-21.17

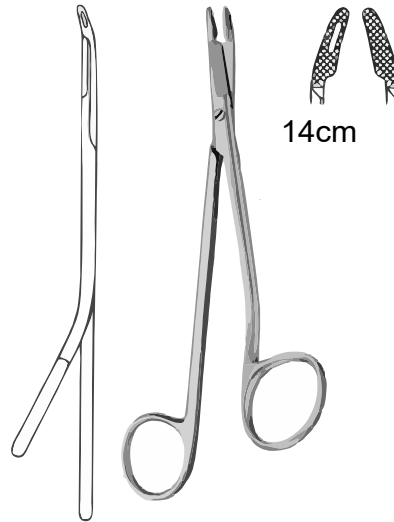

GILLIES SLIM
IM-NH-22.14

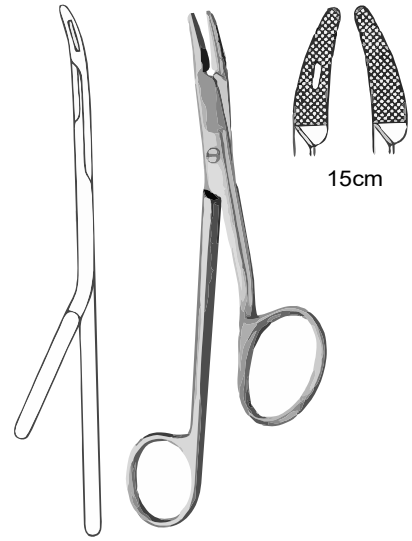

GILLIES
IM-NH-23.15

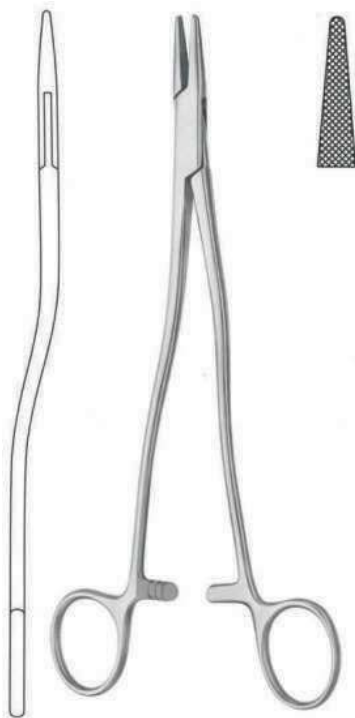

THOMSON WALKER
(BOZEMANN)
IM-NH-24.20
20 cm / 8"



OLSEN-HEGAR
17,0 cm, 6³/₄"
IM-NH-300.17

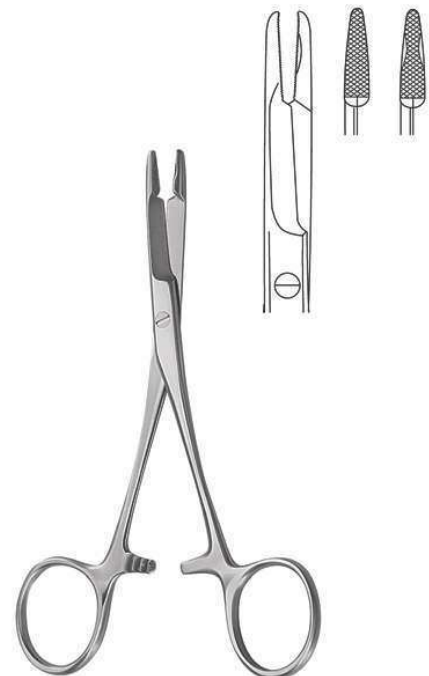

OLSEN-HEGAR
14,0 cm, 5¹/₂"
IM-NH-301.14

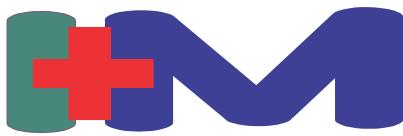

NEEDLE HOLDERS



MATHIEU-KOCHER

IM-NH-25-14
14,0 cm, 5½"



IM-NH-26-17
17,0 cm, 6¾"



IM-NH-27-20
20,0 cm, 8"



BARRAQUER-TROUTMAN
10,0 cm, 4"

IM-NH-28-10



IM-NH-29-10



BARRAQUER

IM-NH-30-10



IM-NH-31-10



BARRAQUER
13,5 cm, 5⅝"
IM-NH-32-13



GOMEL
14,0 cm, 5½"
IM-NH-33-14



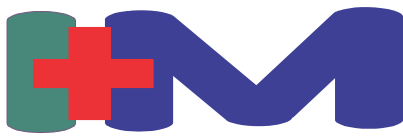

NEEDLE HOLDERS



IM-NH-34-18



IM-NH-35-18

ohne Sperre
without ratchet
sin cremallera
senza cremagliera

18,5 cm, 7¹/₄"



IM-NH-36-18



IM-NH-37-18

mit Sperre
with ratchet
con cremallera
con cremagliera

18,5 cm, 7¹/₄"



IM-NH-38-14



IM-NH-39-14



IM-NH-40-14



IM-NH-21-41-14

mit Sperre
with ratchet
con cremallera
con cremagliera

CASTROVIEJO
14,5 cm, 5³/₄"



IM-NH-42-18



IM-NH-43-18



IM-NH-44-18



IM-NH-45-18

mit Sperre
with ratchet
con cremallera
con cremagliera

CASTROVIEJO
18,0 cm, 7"

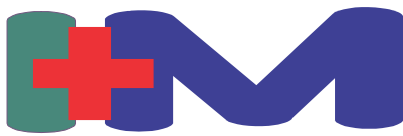

NEEDLE HOLDERS

0,4 mm



gerade, ohne Sperre
straight, without ratchet
recta, sin cremallera
retta, senza cremagliera

14,0 cm, 5 1/2"
IM-NH-46-14

0,4 mm



gebogen, ohne Sperre
curved, without ratchet
curva, sin cremallera
curva, senza cremagliera

14,0 cm, 5 1/2"
IM-NH-47-14

0,4 mm



14,0 cm, 5 1/2"
IM-NH-48-14

0,5 mm



gebogen, ohne Sperre
curved, without ratchet
curva, sin cremallera
curva, senza cremagliera

14,0 cm, 5 1/2"
IM-NH-49-14

Ø 10 mm

0,5 mm



gebogen, ohne Sperre
curved, without ratchet
curva, sin cremallera
curva, senza cremagliera

14,0 cm, 5 1/2"
IM-NH-50-14

Ø 10 mm

0,4 mm



gebogen, ohne Sperre
curved, without ratchet
curva, sin cremallera
curva, senza cremagliera

13,0 cm, 5"
IM-NH-51-13

Ø 8 mm

0,4 mm



gebogen, ohne Sperre
curved, without ratchet
curva, sin cremallera
curva, senza cremagliera

13,0 cm, 5"
IM-NH-52-13

Ø 8 mm

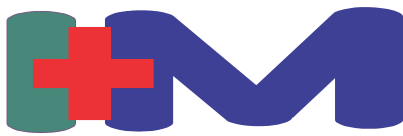

NEEDLE HOLDERS



CONVERSE
IM-NH-53.65
15 cm / 6"



NAGATA

IM-NH-54.61
11.5 cm / 4 1/2"

IM-NH-55.63
13 cm / 5 1/8"



12.5cm

NEIVERT
IM-NH-56.62



GUBISCH
IM-NH-57.61



HALSEY
IM-NH-58.63



HEGAR-BAUMGARTNER

IM-NH-59-12
12,5 cm, 5"

IM-NH-60-14
14,0 cm, 5 1/2"

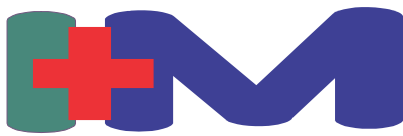

NEEDLE HOLDERS



CRILE WOOD



IM-NH-61.15
15 cm / 6"



IM-NH-62.18
18 cm / 7 1/8"



IM-NH-63.20
20 cm / 8"



IM-NH-64.23
23 cm / 9"



IM-NH-65.25
25 cm / 10"



IM-NH-66.30
30 cm / 11 3/4"



MAYO HEGAR



IM-NH-67.15
15 cm / 6"



IM-NH-68.18
18 cm / 7 1/8"



IM-NH-69.20
20 cm / 8"



IM-NH-70.23
23 cm / 9"



IM-NH-71.24
24 cm / 9 1/2"



IM-NH-72.26
26 cm / 10 1/4"



IM-NH-73.30
30 cm / 11 3/4"

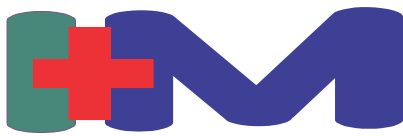

NEEDLE HOLDERS

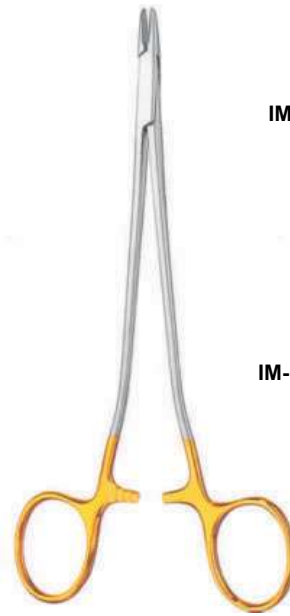

SENNING
IM-NH-21-75.17

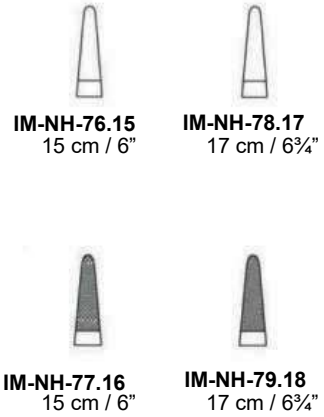

IM-NH-76.15
15 cm / 6"

IM-NH-78.17
17 cm / 6 3/4"

IM-NH-77.16
15 cm / 6"

IM-NH-79.18
17 cm / 6 3/4"

GILLIES SLIM
IM-NH-74.15

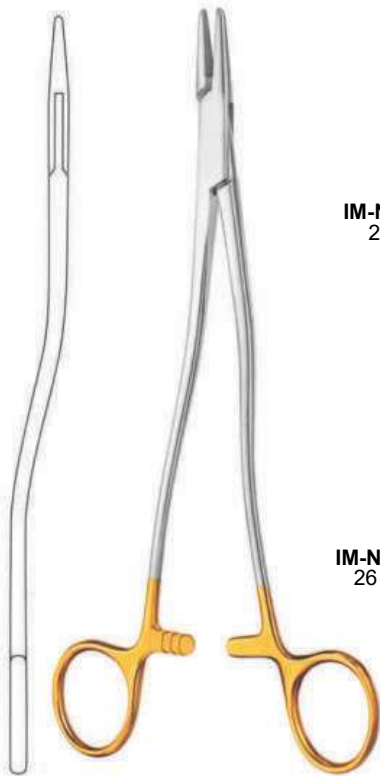

BOZEMANN
(WERTHEIM)

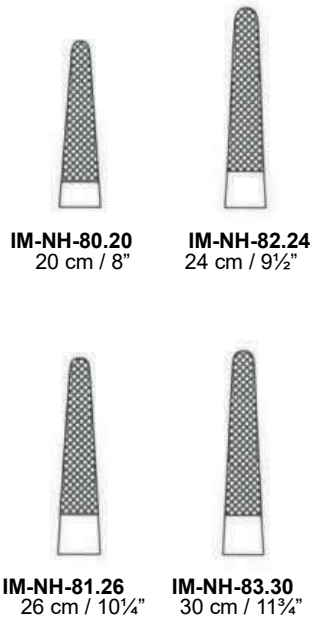

IM-NH-80.20
20 cm / 8"

IM-NH-82.24
24 cm / 9 1/2"

IM-NH-81.26
26 cm / 10 1/4"

IM-NH-83.30
30 cm / 11 1/4"

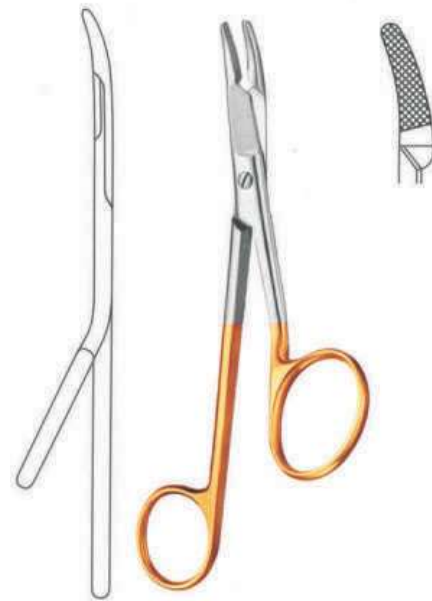

GILLIES
IM-NH-84.16
15.5 cm / 6 1/8"

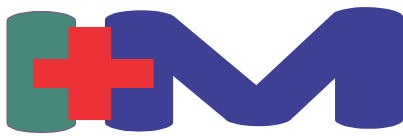

NEEDLE HOLDERS

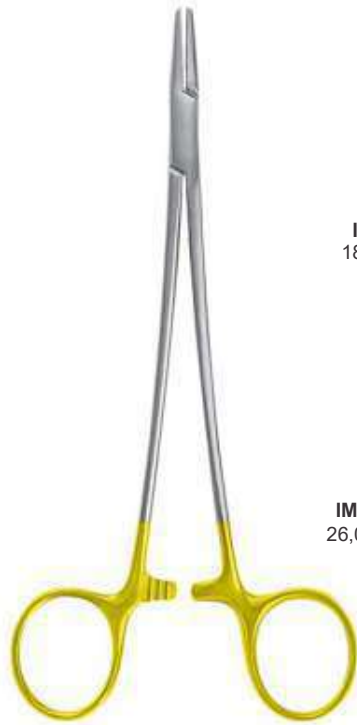

DE BAKEY



IM-NH-85-18
18,0 cm, 7"



IM-NH-86-20
20,0 cm, 8"



IM-NH-87-23
23,0 cm, 9"



IM-NH-88-26
26,0 cm, 10¹/₄"



IM-NH-89-31
31,0 cm, 12¹/₄"



IM-NH-90-37
37,0 cm, 14¹/₂"

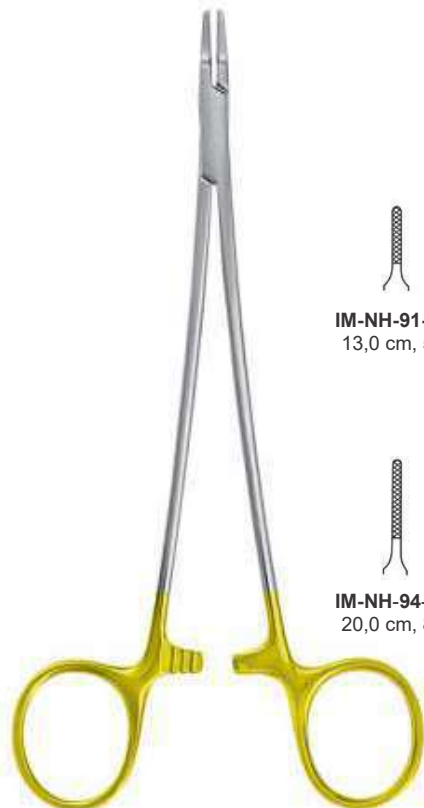

RYDER-VASCULAR



IM-NH-91-13
13,0 cm, 5"



IM-NH-92-15
15,0 cm, 6"



IM-NH-93-18
18,0 cm, 7"



IM-NH-94-20
20,0 cm, 8"

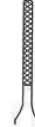

IM-NH-95-23
23,0 cm, 9"



IM-NH-96-26
26,0 cm, 10¹/₄"

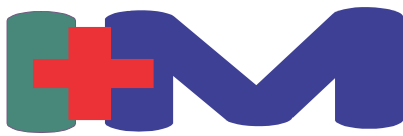

IBRAHIM MEDS

WE SERVE HUMANITY WITH EXCELLENCE

NEEDLE HOLDERS



MATHIEU



IM-NH-97-14
14,0 cm, 5½"



IM-NH-98-17
17,0 cm, 6¾"



IM-NH-99-20
20,0 cm, 8"



LICHTENBERG



IM-NH-100-17
17,0 cm, 6¾"



IM-NH-101-20
20,0 cm, 8"

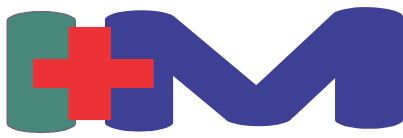

NEEDLE HOLDERS



Microvascular

IM-NH-21-102.15
15 cm / 6"

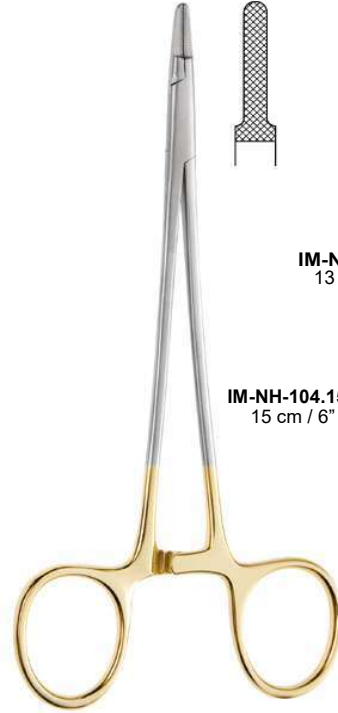

Ryder T.C.

IM-NH-103.13
13 cm / 5 1/8"

IM-NH-104.15
15 cm / 6"

IM-NH-105.18
18 cm / 7 1/8"



BAUMGARTNER, T/C
IM-NH-106-64
14 cm / 5 1/2"

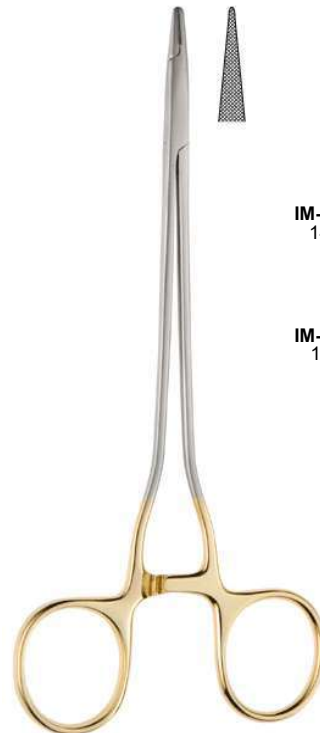

Tebbetts T.C.

IM-NH-107.14
14 cm / 5 1/2"

IM-NH-108.17
17 cm / 6 3/4"

NEEDLE HOLDERS



Wire Twisting , T/C
PN-109-14
14 cm / 5½"

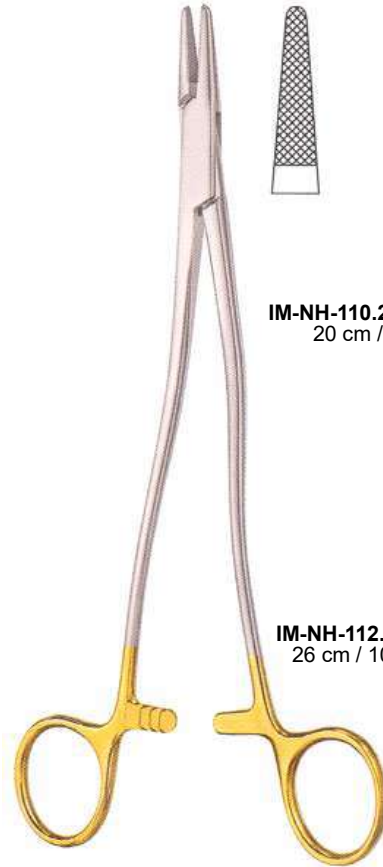

IM-NH-110.20
20 cm / 8"

IM-NH-111.24
24 cm / 9½"

IM-NH-112.26
26 cm / 10¼"

IM-NH-113.30
30 cm / 11¼"

Wertheim T.C. Needle Holder, S-Shape



Tebbetts Intranasal T.C. Needle Holder, Bayonet

IM-NH-114.20
20 cm / 8"

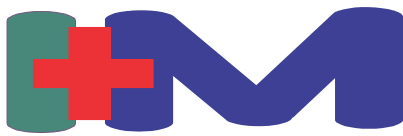

IBRAHIM MEDS

WE SERVE HUMANITY WITH EXCELLENCE

NEEDLE HOLDERS



IM-NH-21-115-14 IM-NH-21-116-14



IM-NH-117-21 IM-NH-118-14

mit Sperre
with ratchet
con cremallera
con cremagliera

CASTROVIEJO
14,5 cm, 5³/₄"



IM-NH-21-119-18 IM-NH-21-120-18



IM-NH-121-18 IM-NH-122-18

mit Sperre
with ratchet
con cremallera
con cremagliera

CASTROVIEJO
18,0 cm, 7"

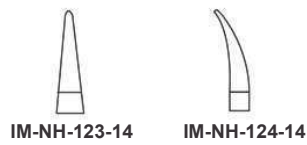

IM-NH-123-14 IM-NH-124-14



IM-NH-125-14 IM-NH-126-14

mit Sperre
with ratchet
con cremallera
con cremagliera

BARRAQUER
14,5 cm, 5³/₄"



HEPP SCHEIDEL
18,0 cm, 7"
IM-NH-127-18

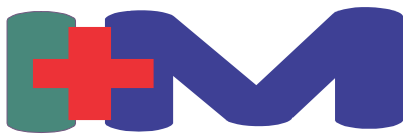

DRESSING & TISSUE FORCEPS

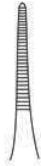

ADSON

12,0 cm, 4⁶/₄" **IM-DT-200-12**
15,0 cm, 6" **IM-DT-201-15**

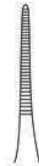

MICRO-ADSON

12,0 cm, 4³/₄" **IM-DT-202-12**
15,0 cm, 6" **IM-DT-203-15**



STILLE

15,0 cm, 6"
IM-DT-204-15



TAYLOR
17,5 cm, 6⁵/₈"
IM-DT-206-17



TAYLOR
17,5 cm, 6⁵/₈"
IM-DT-207-17



TAYLOR
18,5 cm, 7¹/₄"
IM-DT-208-18



GERALD
18,0 cm, 7"
IM-DT-209-18

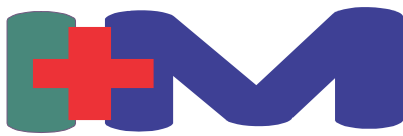

DRESSING & TISSUE FORCEPS



GERALD
18,0 cm, 7"
IM-DT-21-210-18



POTTS-SMITH
18,0 cm, 7" IM-DT-211-18
21,0 cm, 8¹/₄" IM-DT-212-21
25,0 cm, 10" IM-DT-213-25



POTTS-SMITH
18,0 cm, 7" IM-DT-214-18
21,0 cm, 8¹/₄" IM-DT-215-21
25,0 cm, 10" IM-DT-216-25



englische Modelle
english patterns
modelos ingleses
modelli inglese

13,0 cm, 5" IM-DT-217-13
14,5 cm, 5³/₄" IM-DT-218-14
15,0 cm, 6" IM-DT-219-15



CUSHING
17,5 cm, 6⁵/₈"
IM-DT-222-17



CUSHING
17,5 cm, 6⁵/₈"
IM-DT-223-17



BROPHY
20,0 cm, 8"
IM-DT-224-17

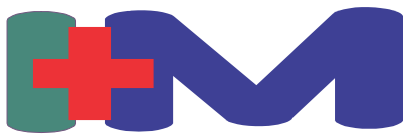

DRESSING & TISSUE FORCEPS



ADSON BROWN
IM-DT-235.72
12 cm / 4 3/4"



ADSON GRAEFE
IM-DT-236.82
12 cm / 4 3/4"



SEMKEN



IM-DT-237.12
12 cm / 4 3/4"



IM-DT-238.22
12 cm / 4 3/4"



IM-DT-239.15
15 cm / 6"



IM-DT-240.25
15 cm / 6"



IM-DT-241.12
12 cm / 4 3/4"



SEMKEN



IM-DT-242.22
12 cm / 4 3/4"



IM-DT-243.15
15 cm / 6"



IM-DT-244.25
15 cm / 6"



SEMKEN
IM-DT-245.32
12 cm / 4 3/4"



MCINDOE
IM-DT-246.15
15 cm / 6"



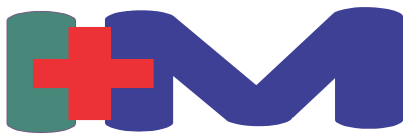

DRESSING & TISSUE FORCEPS



GILLIES
IM-DT-247.85
15 cm / 6"



WAUGH

IM-DT-248.15
15 cm / 6"



IM-DT-249.15
15 cm / 6"



WAUGH

IM-DT-21-250.20
20 cm / 8"



IM-DT-21-251.20
20 cm / 8"



IM-DT-252.40
20 cm / 8"



DEBAKEY
IM-DT-253.15
15 cm / 6"



NELSON

IM-DT-21-254.15
15 cm / 6"



IM-DT-21-255.23
23 cm / 9"



WALTER
IM-DT-256.26
16 cm / 6 1/4"



WALTER
IM-DT-257.36
16 cm / 6 1/4"

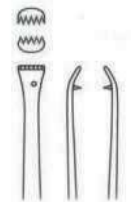

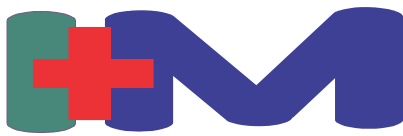

DRESSING & TISSUE FORCEPS



GRUENWALD
IM-DT-258.16
16 cm / 6¼"



TROELTSCH (WILDE)
IM-DT-259.13
13 cm / 5"

Suturing Forceps

Pinzas para sutura
Pincers à suture
Pinze per sutura

0.3 mm 0.3 mm 0.3 mm 0.3 mm



IM-DT-260.50
12 cm / 4¾"



IM-DT-263.51



IM-DT-266.52



IM-DT-269.53

IM-DT-21-261.60 **IM-DT-21-264.61** **IM-DT-21-267.62** **IM-DT-21-270.63**
15 cm / 6"

IM-DT-21-262.70 **IM-DT-21-265.71** **IM-DT-21-268.72** **IM-DT-21-271.73**
18 cm / 7 1/8"



0.6 mm
IM-DT-272.84
23 cm / 9"



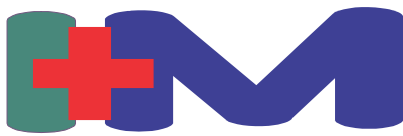

DRESSING & TISSUE FORCEPS



WALTER
IM-DT-273.18
8 cm / 3 1/8"



COTTLE
IM-DT-274.15
15 cm / 6"



FOX

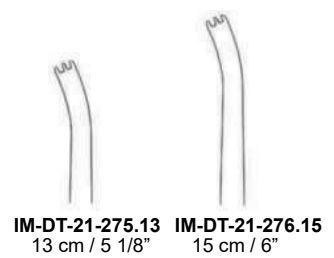

IM-DT-21-275.13 13 cm / 5 1/8"
IM-DT-21-276.15 15 cm / 6"



FOX
IM-DT-277.15
15 cm / 6"

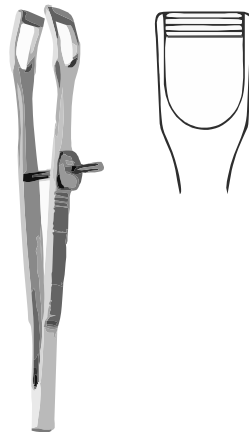

COTTLE
IM-DT-278.15
15 cm / 6"

1 x 2



CUSHING
17,5 cm, 6 5/8"
IM-DT-279-17

1 x 2



CUSHING
17,5 cm, 6 5/8"
IM-DT-280-17

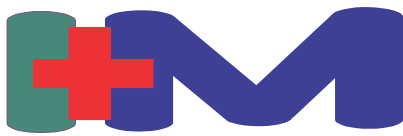

DRESSING & TISSUE FORCEPS

1 x 2



GERALD
18,0 cm, 7"
IM-DT-281-18

1 x 2



GERALD
18,0 cm, 7"
IM-DT-282-18

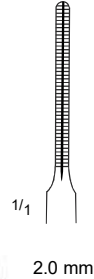

COOLEY
IM-DT-283-16 – 16 cm / 6 1/4"
IM-DT-284-20 – 20 cm / 8"

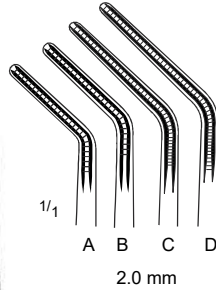

A. IM-DT-285-15 – 15 cm
B. IM-DT-286-19 – 19 cm
C. IM-DT-287-24 – 24 cm
D. IM-DT-288-30 – 30 cm

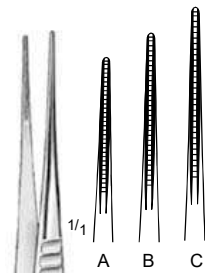

1.5 mm

A. 15 cm / 6"
B. 19.5 cm / 7 3/4"
C. 24 cm / 9 1/2"
D. 30 cm / 12"

A. IM-DT-289-15
B. IM-DT-290-19
C. IM-DT-291-24
D. IM-DT-291-30

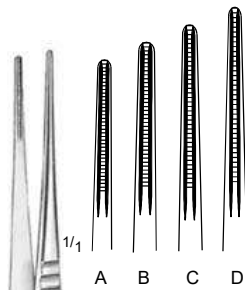

2.0 mm

A. IM-DT-292-15
B. IM-DT-293-19
C. IM-DT-294-24
D. IM-DT-295-30

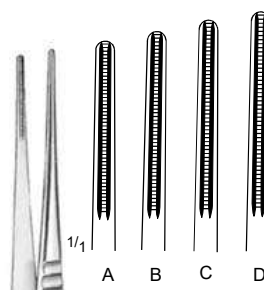

2.7 mm

A. IM-DT-296-15
B. IM-DT-297-19
C. IM-DT-298-24
D. IM-DT-299-30

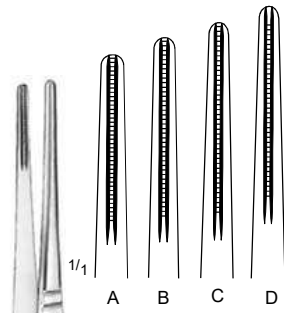

3.5 mm

A. IM-DT-300-15
B. IM-DT-301-19
C. IM-DT-302-24
D. IM-DT-303-30

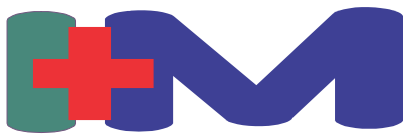

DRESSING & TISSUE FORCEPS

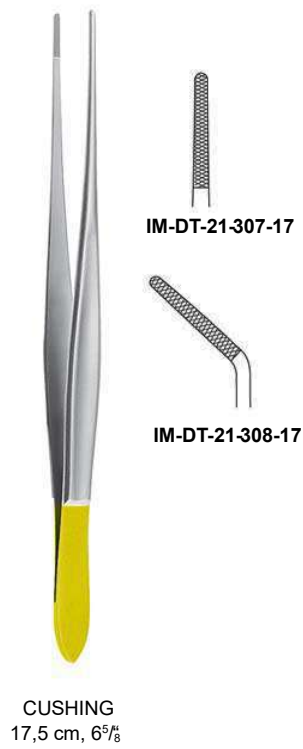
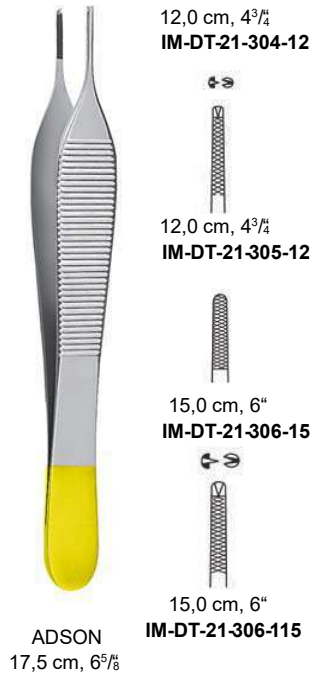

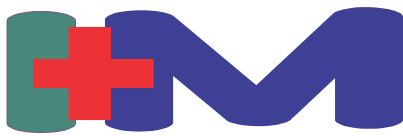

MICRO SURGERY INSTRUMENTS



VESSEL DILATOR

Item Code	Description
IM-MS-400-001	ANGLED, 11cm/ 4¼", 0.2mmØ



VESSEL DILATOR

Item Code	Description
IM-MS-401-002	ANGLED, 11cm/ 4¼", 0.3mmØ



VESSEL DILATOR

Item Code	Description
IM-MS-402-003	ANGLED, 13.5cm/ 5 3/8", 0.2mmØ



VESSEL DILATOR

Item Code	Description
IM-MS-403-004	LONG ANGLED, 13.5cm/ 5 3/8", 0.2mmØ



VESSEL DILATOR

Item Code	Description
IM-MS-404-005	LONG ANGLED, 18cm/ 7", .3mmØ



VESSEL DILATOR

Item Code	Description
IM-MS-405-006	LONG ANGLED, 18cm/ 7", 0.2mmØ

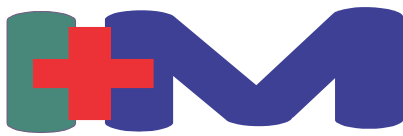

MICRO SURGERY INSTRUMENTS



JEWELLERS FORCEPS

Item Code	Description
IM-MS-413-014	13.5cm/ 5 3/8", 0.3mmØ



Pierse Forceps have a micro hole in the tips which securely grip tissue with minimal trauma



PIERSE FORCEPS

Item Code	Description
IM-MS-414-015	12cm/ 4 3/4", 0.3mmØ



MICRO ADSON FIXATION FORCEPS

Item Code	Description
IM-MS-415-016	12cm/ 4 3/4", 0. 5mmØ, 1X2 MICRO TEETH



ROUND BODIED FORCEPS

Item Code	Description
IM-MS-416-017	15cm/ 6", STRAIGHT, WITH PLATFORM, 0.3mmØ



ROUND BODIED FORCEPS

Item Code	Description
IM-MS-417-018	15cm/ 6", CURVED, WITH PLATFORM, 0.3mmØ



ROUND BODIED FORCEPS

Item Code	Description
IM-MS-418-019	15cm/ 6", ANGLED, 0.2mmØ



ROUND BODIED FORCEPS

Item Code	Description
IM-MS-419-020	18cm/ 7", STRAIGHT, 0.5mmØ

MICRO SURGERY INSTRUMENTS

“Pictures”

“Dimentions”

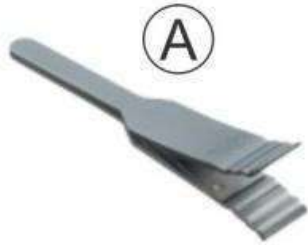

(A)

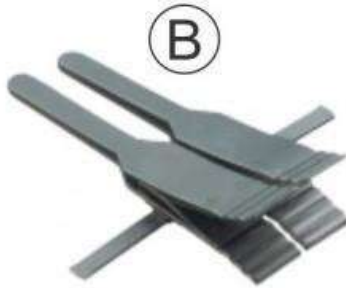
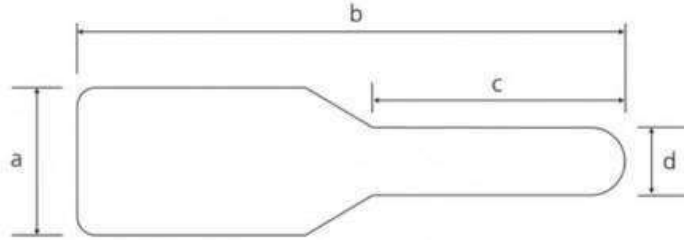

(B)



(C)

Serial Serie	a	b	c	d
RD	6.0	36	16	3.0
HD	4.0	24	10	2.2
B-3	3.5	16.6	7.5	1.7
B-2	3.0	11.3	5.5	1.5
B-1	2.2	8.0	3.8	1.1

Micro Vessel Clips, acc. to Acland, Clip Applying Forceps

IM-MS-420.00

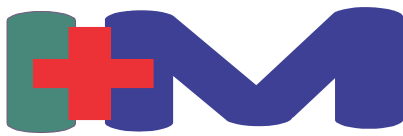

MICRO SURGERY INSTRUMENTS



Blondeel Scissors Round Handle

Item Code	Description
IM-MS-421.01	15cm/ 6", 15mm LONG BLADES
IM-MS-422.02	18cm/ 15mm LONG BLADES



Double Action Micro Needle Holder, Round Bodied

Item Code	Description
IM-MS-423.01	15cm/ 6", 0.4mm JAWS
IM-MS-424.02	18cm/ 0.4mm JAWS



FECHTNER CONJUNCTIVA FORCEPS

Item Code	Description
IM-MS-425.01	10cm LONG



Bishop harmon Iris Forceps

Item Code	Description
IM-MS-426.01	0.3mm, Plain, 9cm LONG
IM-MS-426.02	0.3mm, 1X2TH, 9cm LONG

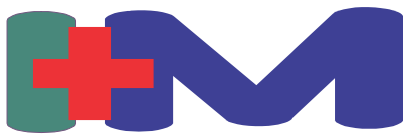

MICRO SURGERY INSTRUMENTS



Putterman clamp, Stainless Steel

Item Code	Description
IM-MS-427.01	10cm LONG



Putterman Gladstone Transmarginal Clamp

Item Code	Description
IM-MS-428.01	10cm LONG



Castroviejo Suturing Forcep 1x2 Teeth, 0.9mm Tip

Item Code	Description
IM-MS-429.01	11cm LONG

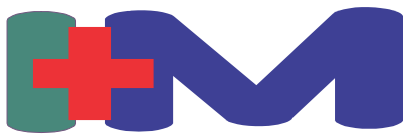

IBRAHIM MEDS

WE SERVE HUMANITY WITH EXCELLENCE

ELECTRO SURGICAL INSTRUMENTS



**Adson Coagulating Forceps,
Serrated, Insulated**

IM-ES-500.12
12 cm / 4 ³/₄"



**Adson Insulated Bipolar,
Forceps, Flat Plug, Non Stick**

IM-ES-501.12
12 cm / 1mm Tip



**Cushing Bayonett Insulated
Bipolar Forceps, 2 Pins Plug
Non Stick**

IM-ES-502.18
18cm



**Cushing Bayonett Insulated
Bipolar Forceps, Flat Plug
Non Stick**

IM-ES-503.18
18cm/ 1mm
Tip



**Jewelers Insulated Bipolar
Forceps, 11.5cm, Flat Plug**

IM-ES-504.18
0.3mm-11.5cm

IM-ES-505.18
0.6mm-11.5cm



**Potts-Smith Insulated Bipolar
Forceps, Straight, 2 Pins Plug
Non Stick**

IM-ES-506.18
0.6mm-18cm

IM-ES-507.18
1.0mm-18cm

IM-ES-508.18
2.0mm-18cm

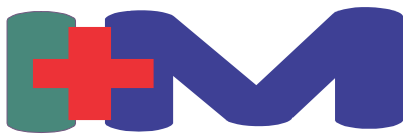

ELECTRO SURGICAL INSTRUMENTS



IM-ES-509.18
0.6mm-18cm

IM-ES-510.18
1.0mm-18cm

IM-ES-511.18
2.0mm-18cm

**Potts-Smith Insulated Bipolar
Forceps, Straight, Flat Plug
Non Stick**



IM-ES-512.15
0.6mm-15cm

IM-ES-513.15
1.0mm-15cm

**Semken Insulated Bipolar
Forceps, Straight, 2 Pins Plug
Non Stick**



IM-ES-514.15
0.6mm-15cm

IM-ES-515.15
1.0mm-15cm

**Semken Insulated Bipolar
Forceps, Angled, 2 Pins Plug
Non Stick**



IM-ES-21-1000.20
**Gerald (Straight), 1mm Tip,
20cm Long, 2 Pins Plug
Non Stick**

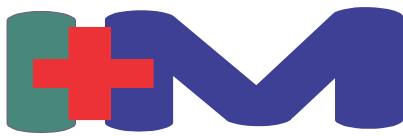

IBRAHIM MEDS

WE SERVE HUMANITY WITH EXCELLENCE

ELECTRO SURGICAL INSTRUMENTS



**Finger Switch Pencil, Reusable
With 3 Meter Silicon Coated Cable
IM-ES-21-516.00**



**Silicon Coated Bipolar
Cable, 2 Pins Plug
3.0 Meters Length
IM-ES-21-517.00**



**Silicon Coated Bipolar
Cable, Flat Plug
3.0 Meters Length
IM-ES-21-518.00**

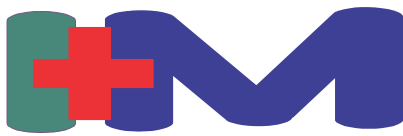

SCALPEL HANDLES



IM-SH-21-60.10
Fig. 10



IM-SH-21-61.11
Fig. 11



IM-SH-21-62.12
Fig. 12

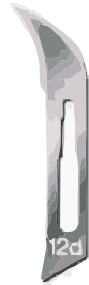

IM-SH-21-63.32
Fig. 12d



IM-SH-21-64.15
Fig. 15



IM-SH-21-65.35
Fig. 15c



IM-SH-21-66.35
Fig. 15c



IM-SH-21-67.23
Fig. 23



IM-SH-21-68.03
No.3
12.5 cm / 5"



IM-SH-21-69.07
No.7
16.5 cm / 6½"



IM-SH-21-70.17
No.7K
12 cm / 4¾"



IM-SH-21-71.13
No.3L
21 cm / 8¼"



IM-SH-21-72.23
No.3LA
20.5 cm / 8"



IM-SH-21-73.40
15.5 cm / 6 1/8"

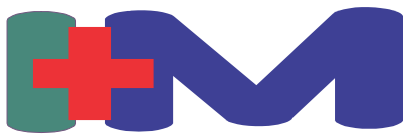

IBRAHIM MEDS

WE SERVE HUMANITY WITH EXCELLENCE

SCALPEL HANDLES



IM-SH-21-74.45
22.5 cm / 9"



IM-SH-21-75.53
27 cm / 10 $\frac{3}{4}$ "



IM-SH-21-76.61
21 cm / 8 $\frac{1}{4}$ "



IM-SH-21-77.63
15.5 cm / 6 1/8"



IM-SH-21-78.64
21 cm / 8 $\frac{1}{4}$ "

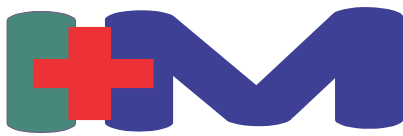

IBRAHIM MEDS

WE SERVE HUMANITY WITH EXCELLENCE

SKIN GRAFTING TOOLS

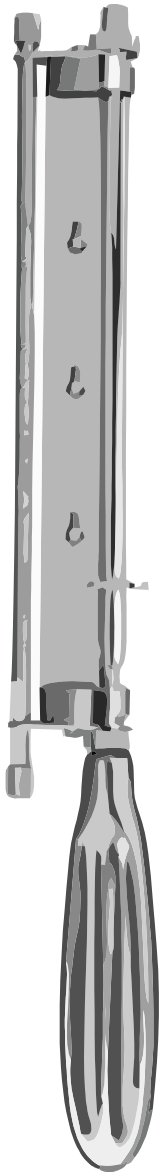

HUMBY
IM-SG-102.30
32 cm / 5½"



IM-SG-100.31
15.5 cm / 6 1/8"

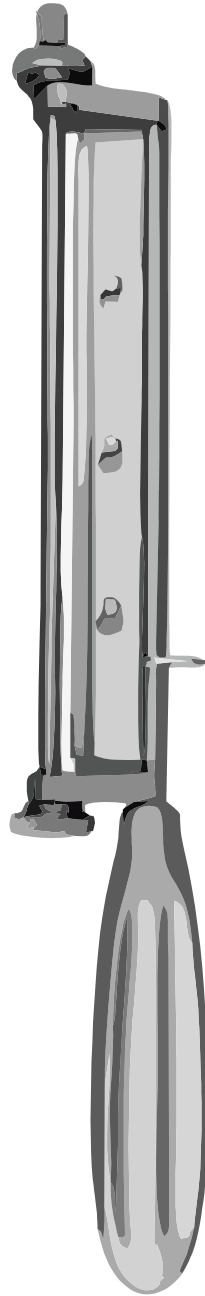

WATSON
IM-SG-103.32
30.5 cm / 12"



SCHINK
IM-SG-104.50
30 cm / 11¾"



IM-SG-101.51
10 cm / 4"



IM-SG-105.52
13 x 7.5 cm



SILVER
IM-SG-106.60
19 cm / 7½"

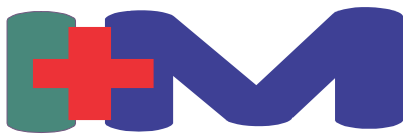

MALLETS



IM-M-100.18
18.5 cm / 7¼"



COTTLE
IM-M-101.40
19 cm / 7½"

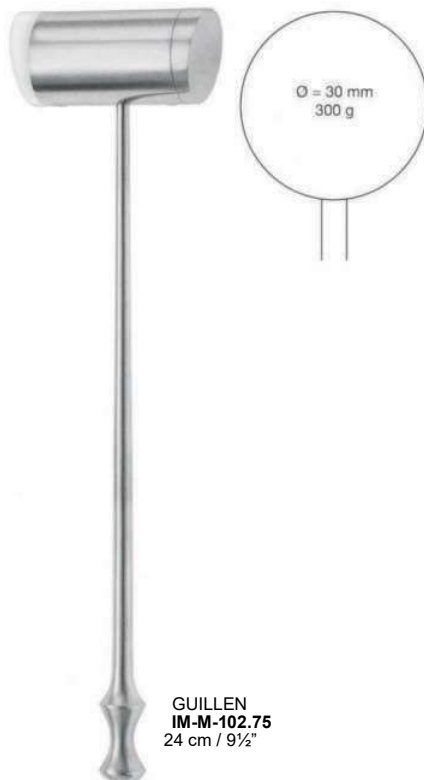

GUILLEN
IM-M-102.75
24 cm / 9½"



26 cm / 10¼"
Ø = 35 mm, 150 g **IM-M-103.35**
Ø = 45 mm, 240 g **IM-M-104.45**
Ø = 50 mm, 330 g **IM-M-105.50**

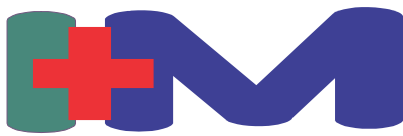

MALLETS

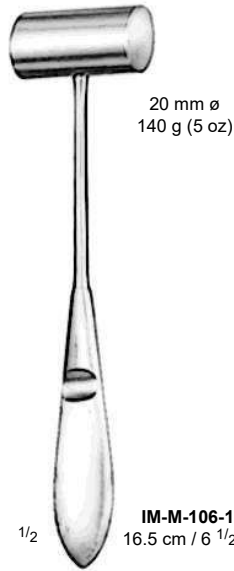

20 mm ø
140 g (5 oz)

IM-M-106-16
16.5 cm / 6 1/2"

1/2



40 mm ø
690 g
(1 1/2" lbs)

KIRK
IM-M-107-20
19.5 cm / 7 3/4"



30 mm & 42 mm ø
530 g 1lb. 3 oz)

IM-M-108-24
24 cm / 9 1/2"

1/2



IM-M-109-01
25m ø
120 g (4 1/4 oz)

IM-M-110-02
30m ø
180 g (6 1/4 oz)

IM-M-111-03
35m ø
260 g (9 1/4 oz)

DOYEN
IM-M-109-01 – IM-M-111-03
21 cm / 8 1/4"

1/2



Bergmann
IM-M-114-23
24 cm / 9"



30 mm ø
220 gm
(7 1/2 oz)

COLLIN
IM-M-115-20
20 cm / 8"

1/2

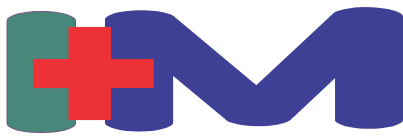

MALLETS

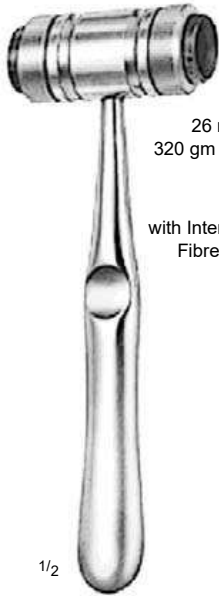

26 mm ø
320 gm (11 1/2 oz)

with Interchangeable
Fibre Facings

1/2

MEAD
IM-M-116-19
18 cm / 7"



30 mm ø
400 gm (14 oz)

GERZOG
IM-M-117-18
18 cm / 7"

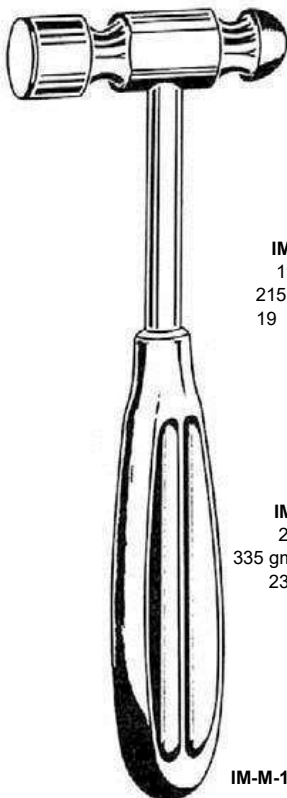

IM-M-118-19
19 mm ø
215 gm (7 oz)
19 cm / 7 1/2"

IM-M-119-25
25 mm ø
335 gm (11 1/2" ozs)
23 cm - 9"

IM-M-118-19 - IM-M-119-25

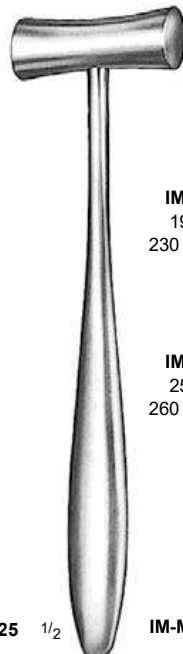

IM-M-122-01
19 mm ø
230 gm (8 oz)

IM-M-123-02
25 mm ø
260 gm (9 oz)

LUCAE
IM-M-122-01 - IM-M-123-02
19 cm 7 1/2"



30 mm ø
510 gm
(18 oz)

1/3

IM-M-126-22
26 cm 10 1/2"

RETRACTORS



YANCOSKIE ABDOMINOPLASTY RET.

Item Code	Description
IM-R-201.19	OFFSET 7 1/2" (190mm) WIDTH 150mm

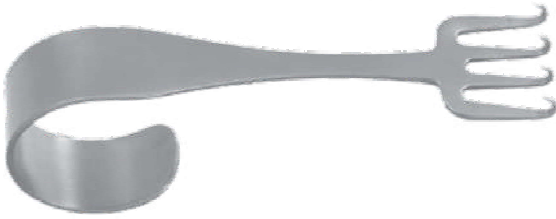

FREEMAN FACE LIFT RETRACTOR

Item Code	Description
IM-R-202.01	SMALL FINGER RING, 4" (102mm) WIDTH 21.8mm
IM-R-203.02	LARGE FINGER RING, 4 3/4" (121mm) WIDTH 25mm

RETRACTORS



MAMMAPLASTY OR MASTECTOMY HOOK

Item Code	Description
IM-R-204.19	EXTRA LARGE, SHARP, 7½" (191mm), 10mm



FREEMAN SKIN HOOK, 4" (102mm)

Item Code	Description
IM-R-205.10	SINGLE SHARP HOOK, 5mm
IM-R-206.10	DOUBLE SHARP HOOK, 5mm



Anderson Bear Claw Retractor

Item Code	Description
IM-R-207.07	THREE PRONG, 12CM
IM-R-208.12	FIVE PRONG, 12CM



MILLARD THUMB SINGLE HOOK

Item Code	Description
IM-R-209.05	STANDARD, 5mm



MILLARD THUMB DOUBLE HOOK

Item Code	Description
IM-R-210.17	STANDARD, 17mm

RETRACTORS



FREEMAN FACE LIFT RETRACTOR

Item Code	Description
IM-R-211.18	ADAMSON MODEL, 7"(178mm), 37mm

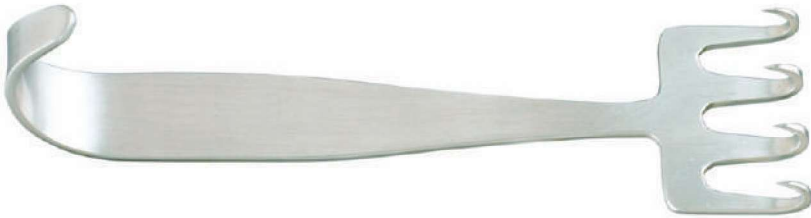

Item Code	Description
IM-R-212.11	FREEMAN FLAP RAKE RETRACTOR 4¼" (108mm), 1¼"(32mm)



FREEMAN RAKE RETRACTOR

Item Code	Description
IM-R-213.10	4" (100mm), WIDTH (22mm)
IM-R-214.10	4" (100mm), WIDTH (38mm)



GORNEY RAKE RETRACTOR

Item Code	Description
IM-R-215.08	3" (75mm), WIDTH (38mm)
IM-R-216.11	4¼" (108mm), WIDTH (38mm)

RETRACTORS

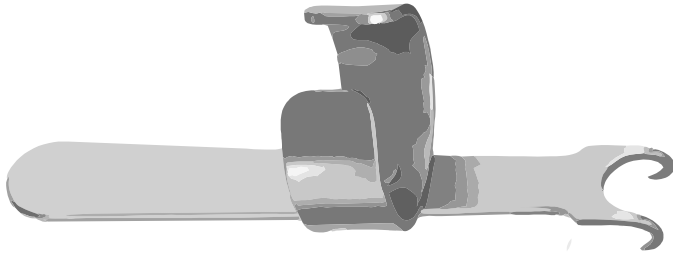

SWIVEL DOUBLE HOOK/RETRACTOR

Item Code	Description
IM-R-217.09	2 SHARP PRONG WITH SWIVEL RING 3½" (89mm), 10mm

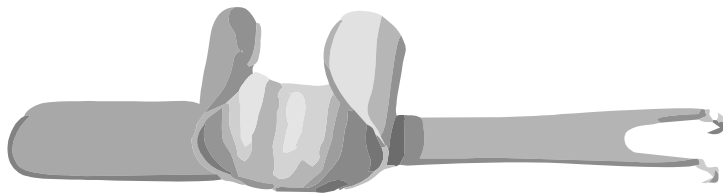

MARTINEZ-KILNER NASAL RETRACTOR

Item Code	Description
IM-R-218.11	2 SHARP PRONGS WITH THUMB RING 4½" (114mm) 7.5mm



SHEEN NASAL RETRACTOR

Item Code	Description
IM-R-219.17	ANGLED, 6½" (165mm), 10mm



SHEEN RETRACTOR

Item Code	Description
IM-R-220.16	CURVED, 6¼" (159mm), 6.5mm



RIBBON RETRACTOR

Item Code	Description
IM-R-221.17	INFANT, 6¾" (171mm), 5/8" (16mm)
IM-R-222.20	PEDIATRIC, 8" (203mm), 5/8" (16mm)
IM-R-223.20	PEDIATRIC, 8" (203mm), 1" (25mm)

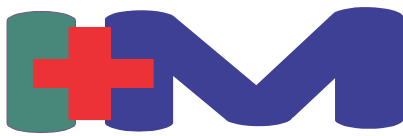

RETRACTORS



Freeman Rake Retractor

Item Code	Description
IM-R-224.10	18cm,WIDTH (22mm)
IM-R-225.10	18cm, WIDTH (38mm)



Item Code	Description
IM-R-226.11	Cronin Lip And Nostril Retractor 15.5cm



Walter Rake Retractor

Item Code	Description
IM-R-227.10	18cm,WIDTH (22mm)
IM-R-228.10	18cm, WIDTH (38mm)



Coronal Brow Lift 7 Prongs Retractor

Item Code	Description
IM-R-229.18	7 Prongs , 18cm

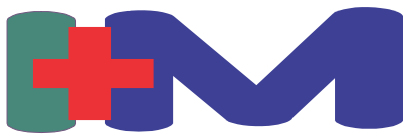

RETRACTORS



U.S. ARMY RETRACTOR, SET OF 2

Item Code	Description
IM-R-230.21	8½" (216mm)



U.S. ARMY RETRACTOR insulated, SET OF 2

Item Code	Description
IM-R-231.21	8½" (216mm)



Farabeuf Retractor Set of 2

Item Code	Description
IM-R-232.10	Set of 2 (12cm)
IM-R-233.10	Set of 2 (15cm)



Farabeuf Retractor Set of 2, Insulated

Item Code	Description
IM-R-234.10	Set of 2 (12cm)
IM-R-235.10	Set of 2 (15cm)

RETRACTORS



Senn Miller Retractor Insulated, 16cm, Sharp And Blunt

IM-R-236.16 SHARP PRONGS

IM-R-237.16 BLUNT PRONGS



Kawamoto Double Ended Retractor, 16cm, INSULATED

IM-R-238.16 No. 1

IM-R-239.16 No. 2

IM-R-240.16 No. 3



Fomon Retractor, Insulated, 17cm

IM-R-241.17 Ball Tips, 5x10mm



Desmarres Eye Lid Retractor, 14cm, INSULATED

IM-R-242.00 No. 0

IM-R-243.01 No. 1

IM-R-244.02 No. 2

IM-R-245.03 No. 3

IM-R-246.04 No. 4

RETRACTORS



DEAVER RETRACTOR,

Item Code	Description
IM-R-247.30	12" (305mm), 1" (25mm)



Deaver Retractor Insulated, 20cm, 25mm Wide

Item Code	Description
IM-R-248.20	8" (305mm), 1" (25mm)



FREEMAN FLAP RETRACTOR

Item Code	Description
IM-R-249.20	8" (203mm) ½" (13mm)
IM-R-250.20	8" (203mm) 1" (25mm)

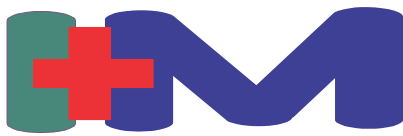

RETRACTORS



PARKER RETRACTOR, SET OF 2

<u>Item Code</u>	<u>Description</u>
IM-R-251.21	Set of 2, 13cm



Roux Baby Retractor

<u>Item Code</u>	<u>Description</u>
IM-R-252.21	8½" (216mm)



Roux Retractors, Set of 3

<u>Item Code</u>	<u>Description</u>
IM-R-253.16	16CM



Tebbetts Aufricht Retractor

<u>Item Code</u>	<u>Description</u>
IM-R-254.18	12CM

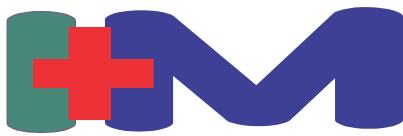

RETRACTORS



Epstein-Deaver Retractor, 20cm, 25mm Wide

Item Code	Description
IM-R-255.20	8" (200mm), 1" (25mm)



Richardson Retractor, 25cm, 19mm X 25mm Blade

Item Code	Description
IM-R-256.25	10" (250mm)



Richardson Retractor Double Ended Set of 2

Item Code	Description
IM-R-257.20	Large Blade: 27cm Length, 63mm x 42mm / 39mm x 37mm Wide
IM-R-258.20	Small Blade: 20cm Length, 30mm x 29mm / 24mm x 22mm Wide

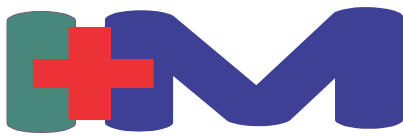

RETRACTORS



Meyerding Retractor

Item Code	Description
IM-R-259.20	Medium Blade 25mm x 75mm 20cm
IM-R-260.20	Large Blade 50mm x 90mm 23cm



Rollet Retractor 4 Prongs

Item Code	Description
IM-R-261.25	14CM



Cronin Cheek Retractor, 16cm, 19mm Wide

Item Code	Description
IM-R-262.16	6" (160mm)(19mm)

ABDOMINAL RETRACTORS



Saldanha Abdominal Retractor 23cm Style-1 , Six Prongs

IM-AR-300.20

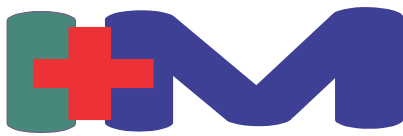

ABDOMINAL RETRACTORS

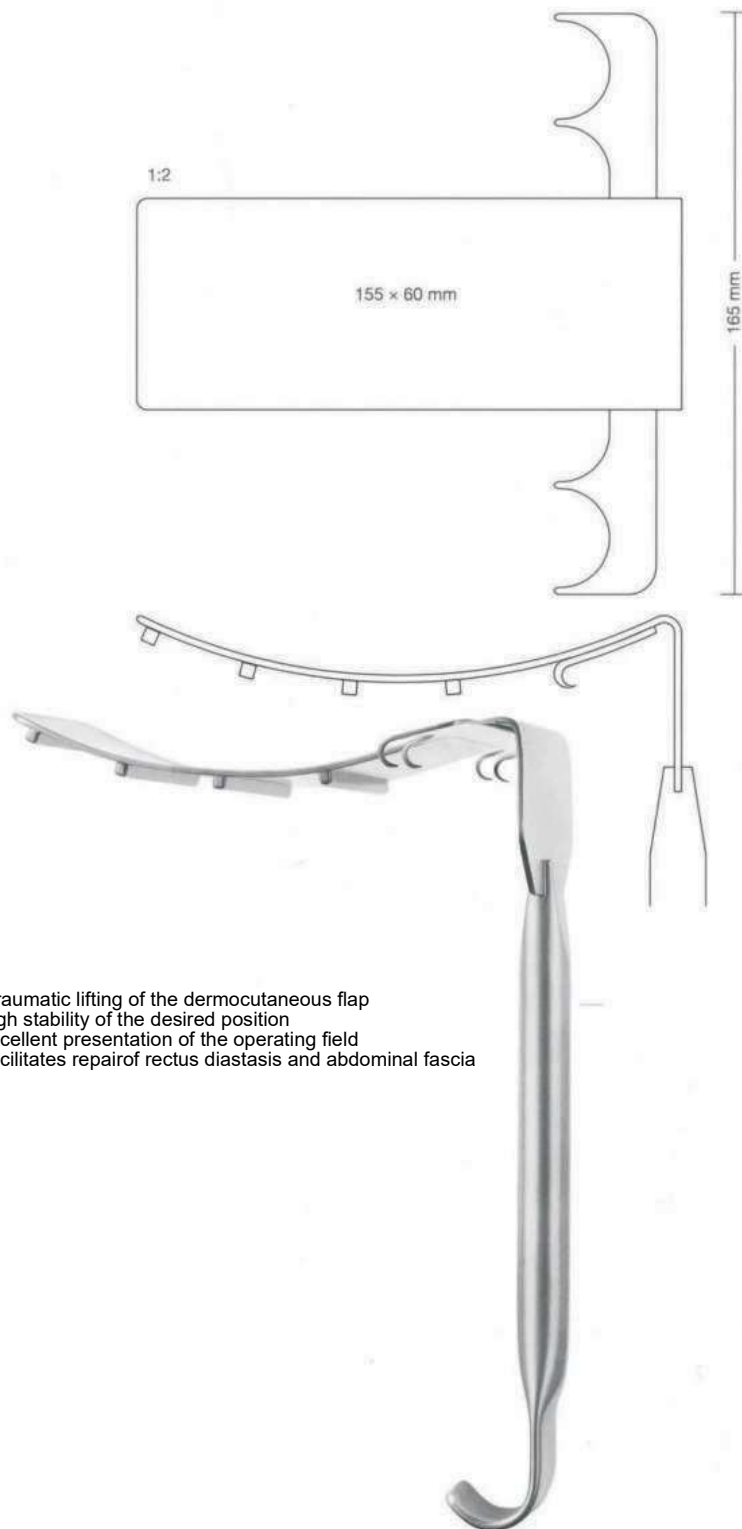

Atraumatic lifting of the dermocutaneous flap
High stability of the desired position
Excellent presentation of the operating field
Facilitates repair of rectus diastasis and abdominal fascia

Saldanha Abdominal Retractor 23cm Style-2, Four Prongs

IM-AR-301.20

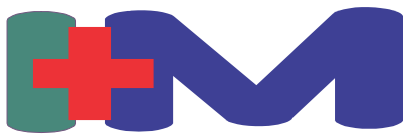

DELICATE RETRACTORS

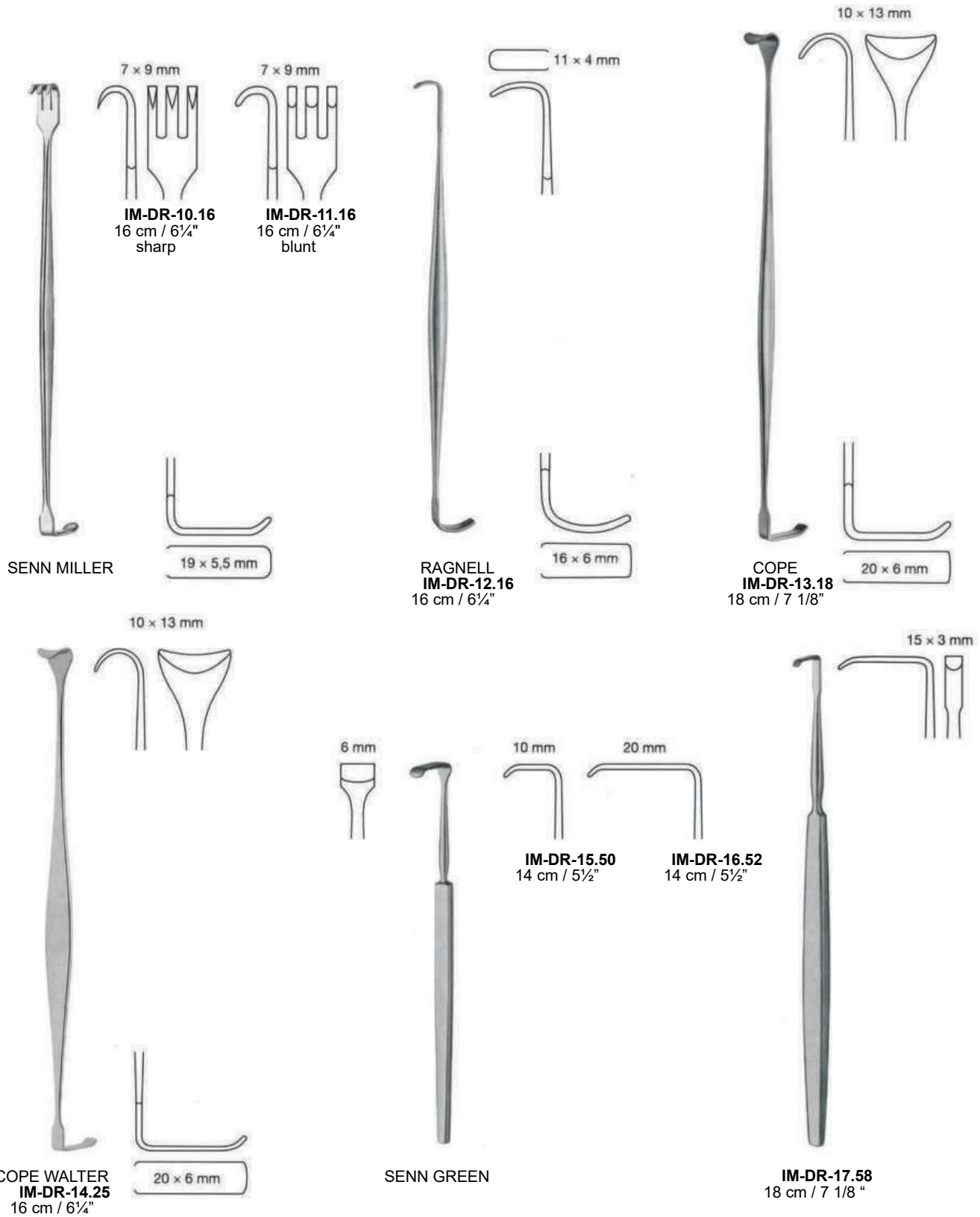

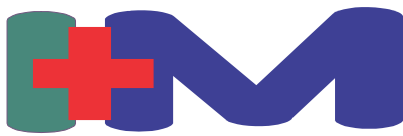

DELICATE RETRACTORS

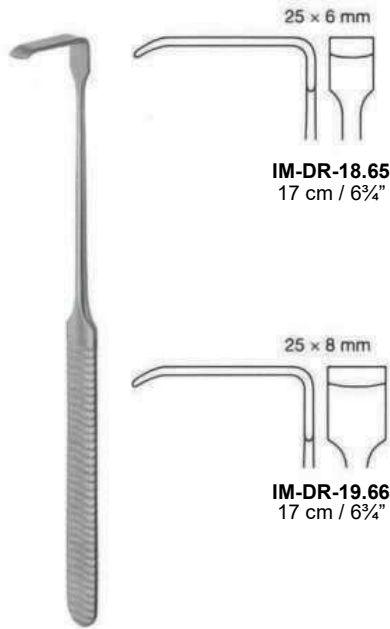

25 x 6 mm
IM-DR-18.65
17 cm / 6 3/4"

25 x 8 mm
IM-DR-19.66
17 cm / 6 3/4"

LANGENBECK GREEN



15 x 6 mm
IM-DR-20.75
17 cm / 6 3/4"

18 x 6 mm
IM-DR-21.85
17 cm / 6 3/4"

STRANDELL STILLE



3 mm
IM-DR-22.20
20 cm / 8" sharp

3 mm
IM-DR-23.20
20 cm / 8" blunt

ADSON



CRILE
IM-DR-24.20
20 cm / 8"



FRAZIER
IM-DR-25.12
12.5 cm / 5"

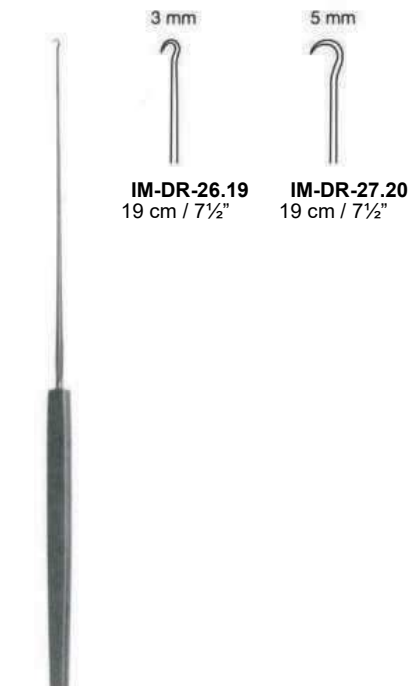

3 mm
IM-DR-26.19
19 cm / 7 1/2"

5 mm
IM-DR-27.20
19 cm / 7 1/2"

GILLIES

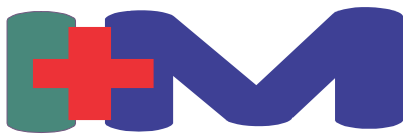

DELICATE RETRACTORS

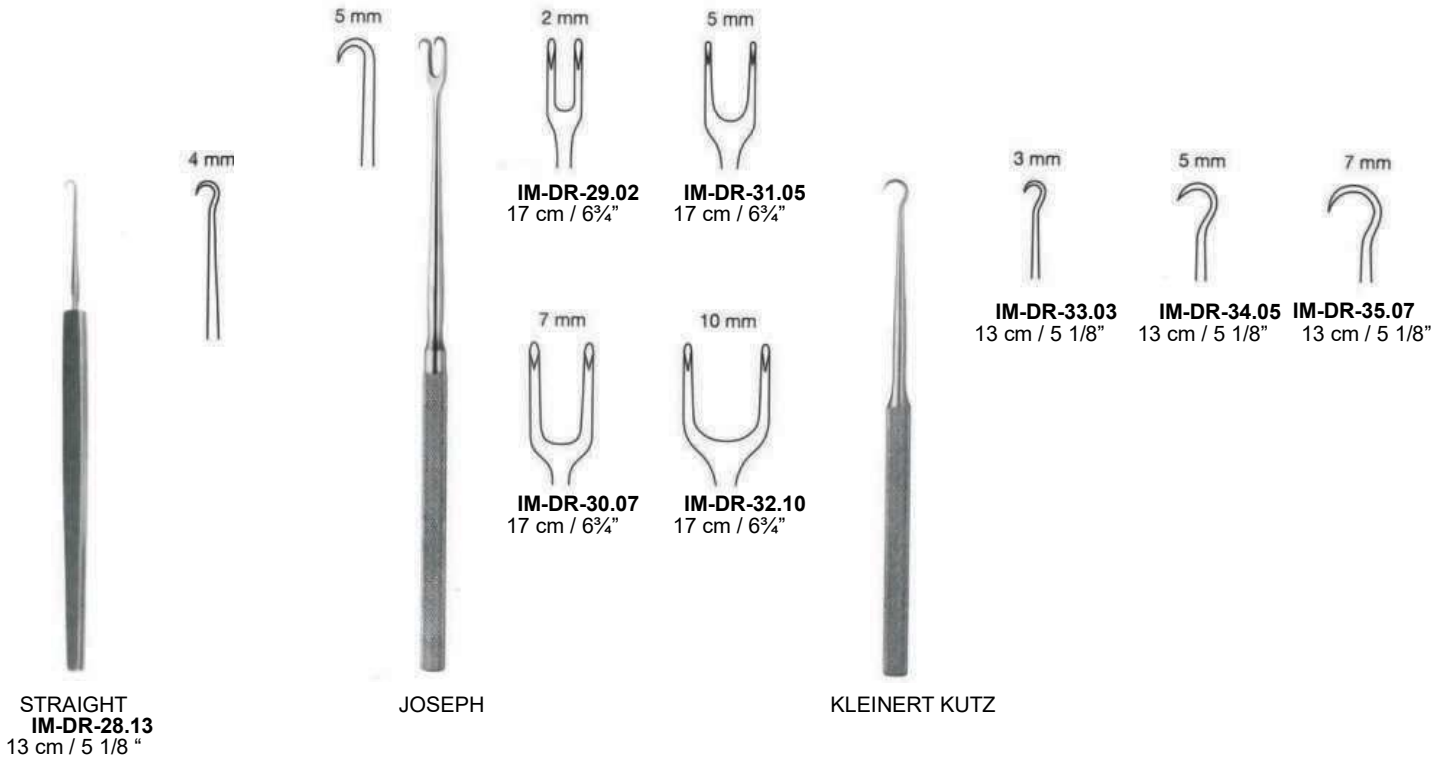

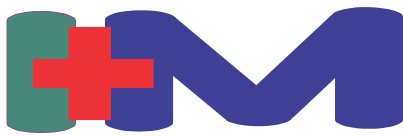

DELICATE RETRACTORS



JOSEPH
IM-DR-40.16
16 cm / 6 1/4"



HUMBY
IM-DR-41.21
11.5 cm / 4 1/2"



BERGMANN
IM-DR-42.24
14 cm / 5 1/2"

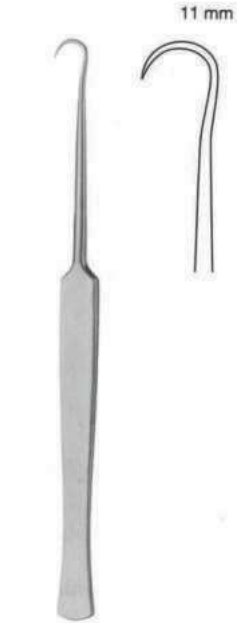

IM-DR-43.26
16.5 cm / 6 1/2"

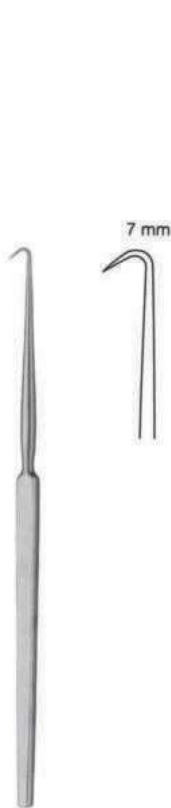

COTTLE
IM-DR-44.36
16 cm / 6 1/4"



EMMET
IM-DR-45.42
22 cm / 8 3/4"



BENICKE



IM-DR-46.50
19 cm / 7 1/2"
sharp



IM-DR-47.51
19 cm / 7 1/2"
blunt



GUTHRIE



IM-DR-48.13
13 cm / 5 1/8"

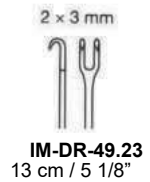

IM-DR-49.23
13 cm / 5 1/8"

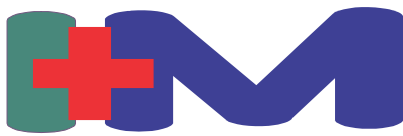

IBRAHIM MEDS

WE SERVE HUMANITY WITH EXCELLENCE

DELICATE RETRACTORS

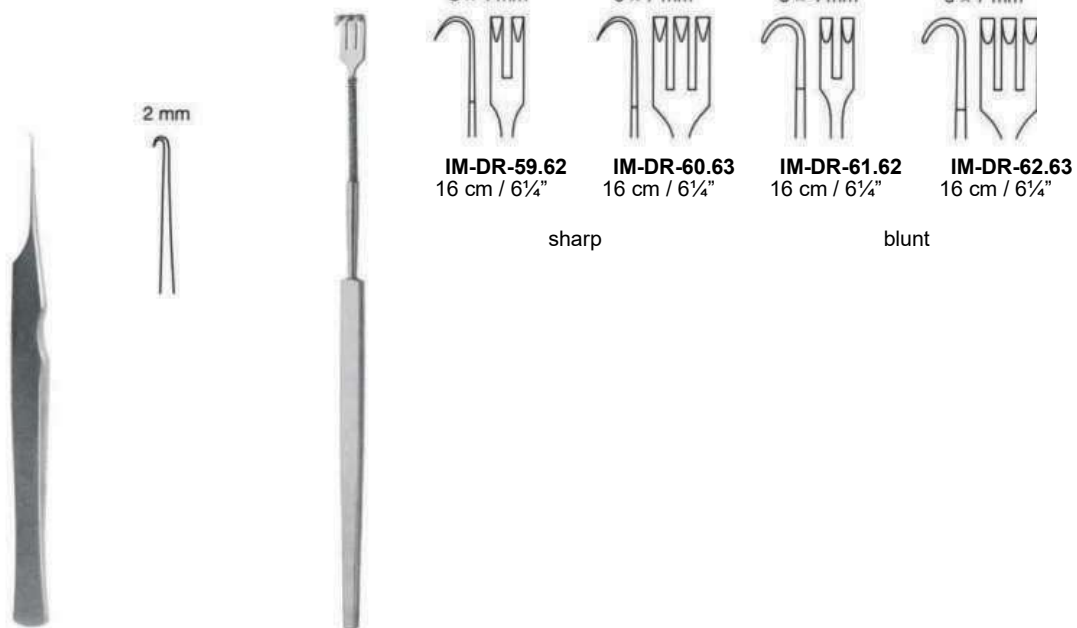
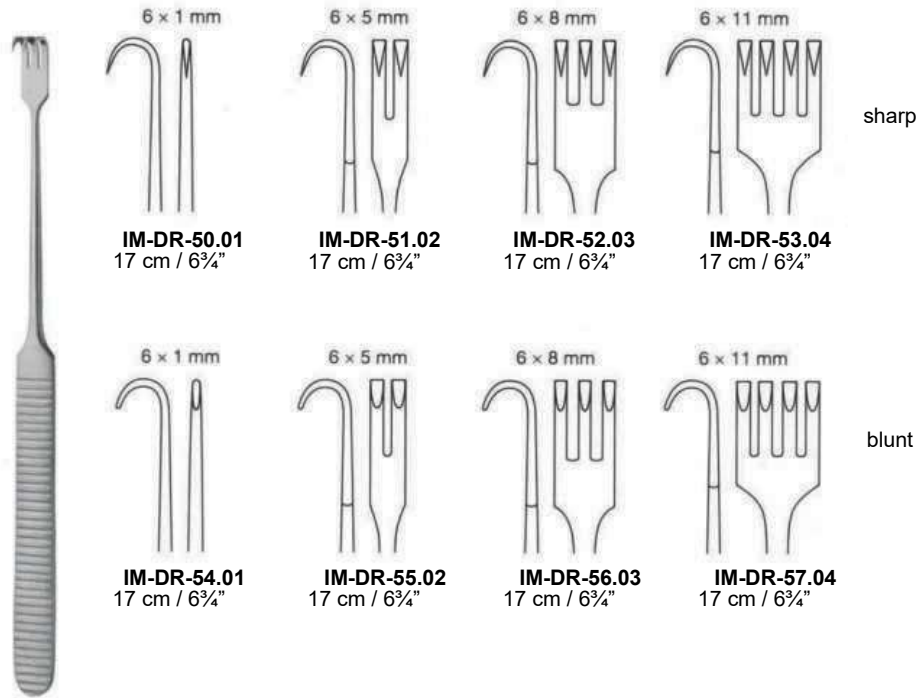

LAHEY CLINIC
IM-DR-58.15
13 cm / 5 1/8"

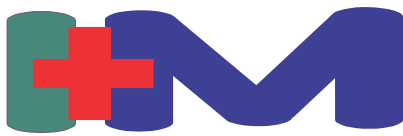

IBRAHIM MEDS

WE SERVE HUMANITY WITH EXCELLENCE

DELICATE RETRACTORS

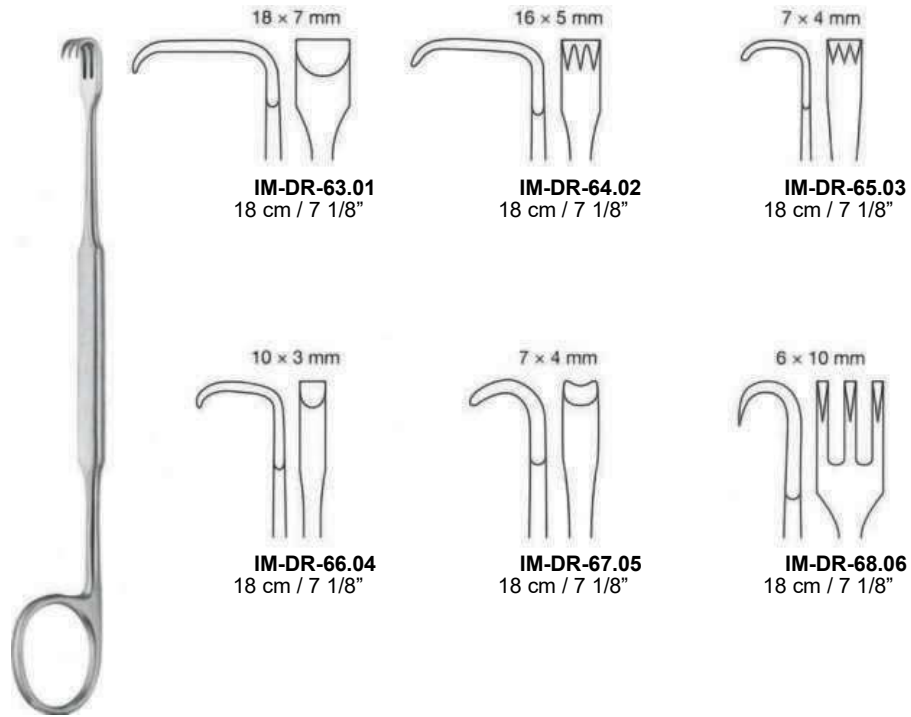

MEYERDING

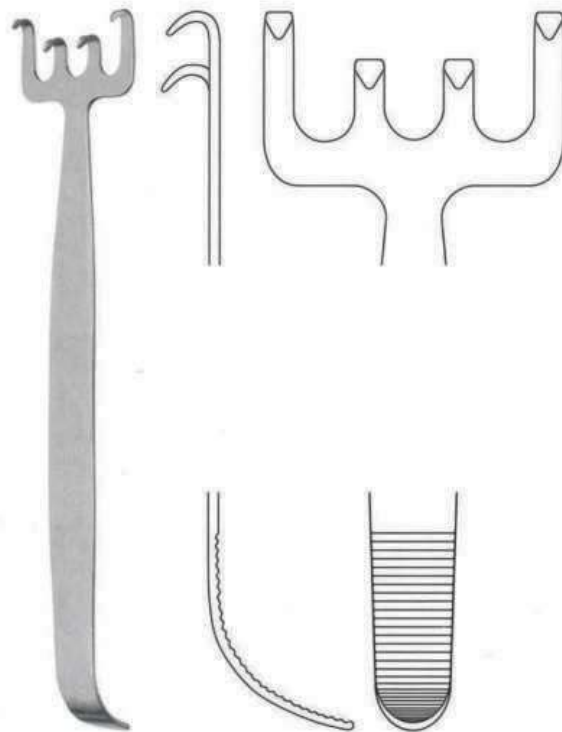

WALTER
IM-DR-69.39
19 cm / 7½"

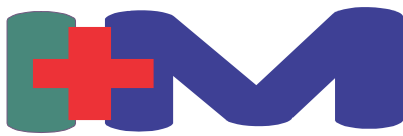

IBRAHIM MEDS

WE SERVE HUMANITY WITH EXCELLENCE

DELICATE RETRACTORS

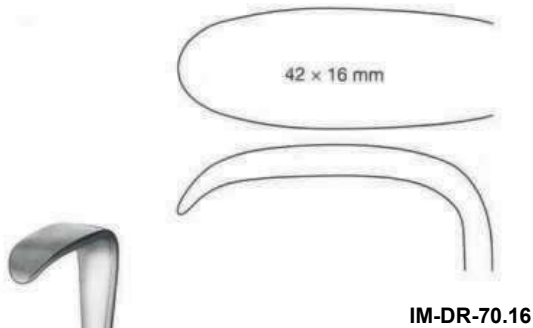

IM-DR-70.16

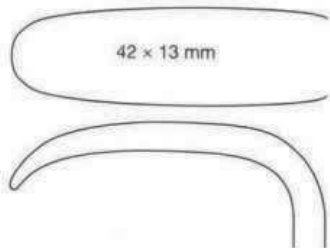

IM-DR-71.13



IM-DR-72.12

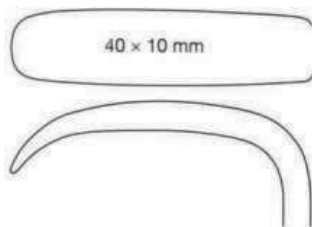

IM-DR-73.10

KOCHER
21 cm / 8¼"

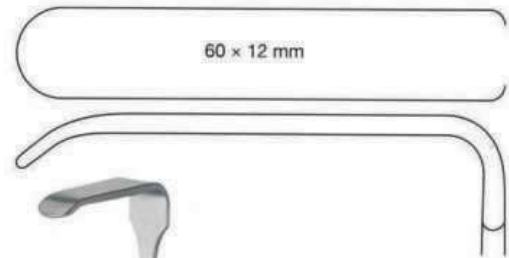

IM-DR-74.32

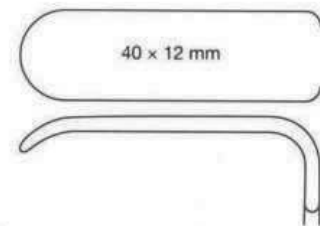

IM-DR-75.31

KOCHER
22 cm / 8¾"

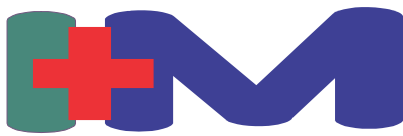

DELICATE RETRACTORS

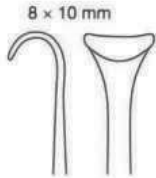

8 x 10 mm

IM-DR-76.00
14 cm / 5½"
#0

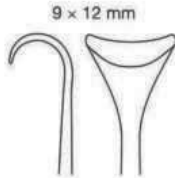

9 x 12 mm

IM-DR-77.01
14 cm / 5½"
#1

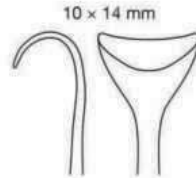

10 x 14 mm

IM-DR-78.02
14 cm / 5½"
#2

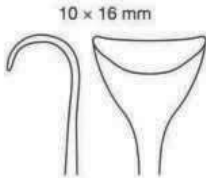

10 x 16 mm

IM-DR-79.03
14 cm / 5½"
#3

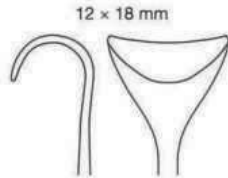

12 x 18 mm

IM-DR-80.04
14 cm / 5½"
#4



DESMARRES

Mandibular rim retractor
Separador para el borde del maxilar inferior
Ecarteur pour le bord du maxillaire inférieur
Divaricatore per il bordo della mascella inferiore

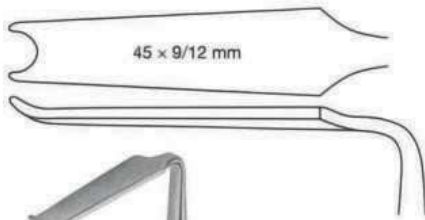

45 x 9/12 mm

OBWEGESER
IM-DR-81.17
17 cm / 6¾"



OBWEGESER
22 cm / 8¾"

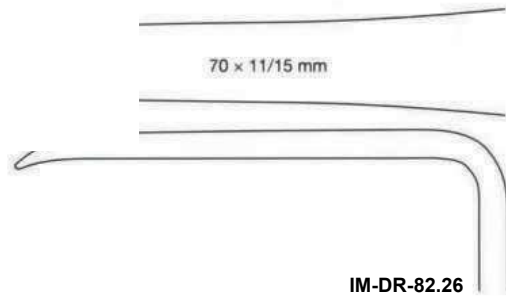

70 x 11/15 mm

IM-DR-82.26

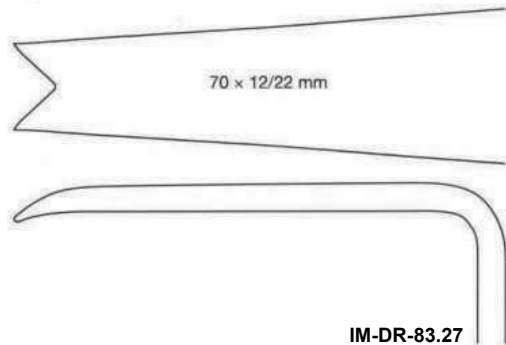

70 x 12/22 mm

IM-DR-83.27

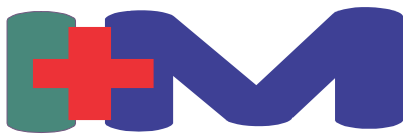

IBRAHIM MEDS

WE SERVE HUMANITY WITH EXCELLENCE

DELICATE RETRACTORS

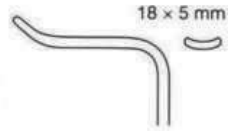

IM-DR-84.31

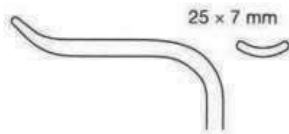

IM-DR-85.32

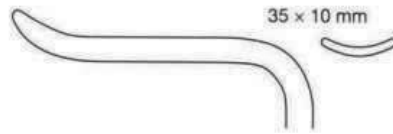

IM-DR-86.33

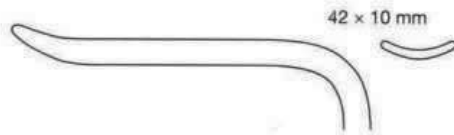

IM-DR-87.34

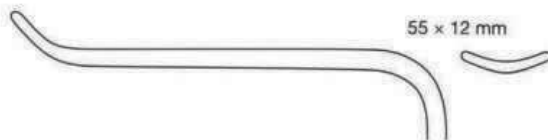

IM-DR-88.35



IM-DR-89.36

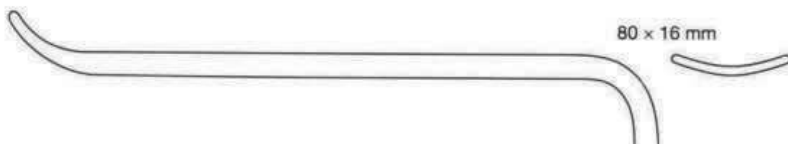

IM-DR-90.37



OBWEGESER
23 cm / 9"

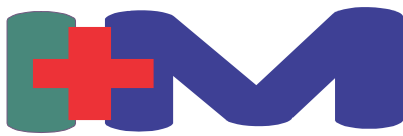

IBRAHIM MEDS

WE SERVE HUMANITY WITH EXCELLENCE

DELICATE RETRACTORS

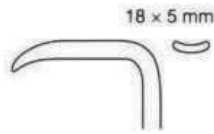

IM-DR-91.41

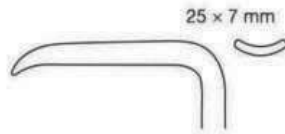

IM-DR-92.42

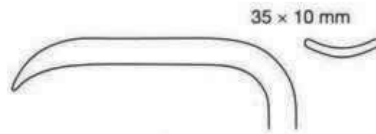

IM-DR-93.43

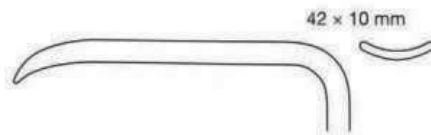

IM-DR-94.44

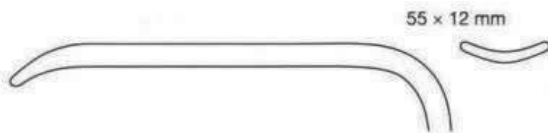

IM-DR-95.45

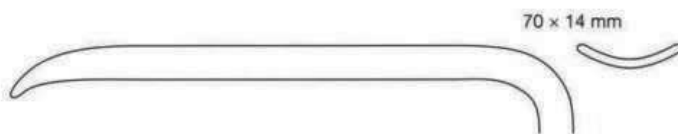

IM-DR-96.46

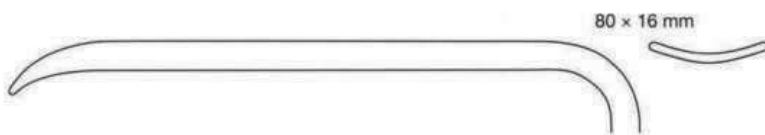

IM-DR-97.47



OBWEGESER
22.5 cm / 9"

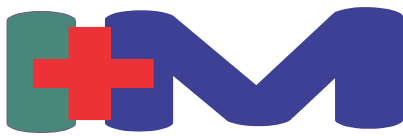

DELICATE RETRACTORS



OBWEGESER

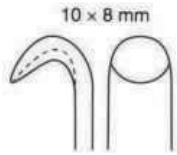

IM-DR-98.26
17.5 cm / 7"

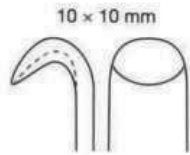

IM-DR-99.27
17.5 cm / 7"

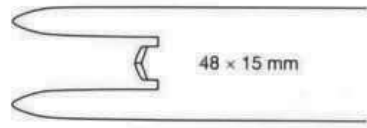

OBWEGESER
IM-DR-100.28
16 cm / 6 1/4"



DOYEN
17 cm / 6 3/4"

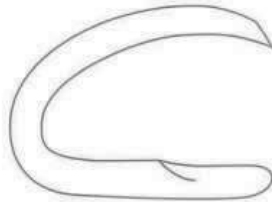

IM-DR-101.11
right

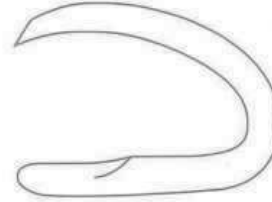

IM-DR-102.12
left

Instruments for Auricular Plastic
Instrumentos para la otoplastia
Instruments pour l'otoplastie
Strumenti per l'otoplastica

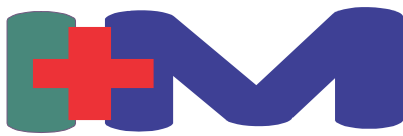

IBRAHIM MEDS

WE SERVE HUMANITY WITH EXCELLENCE

SELF-RETAINING RETRACTORS

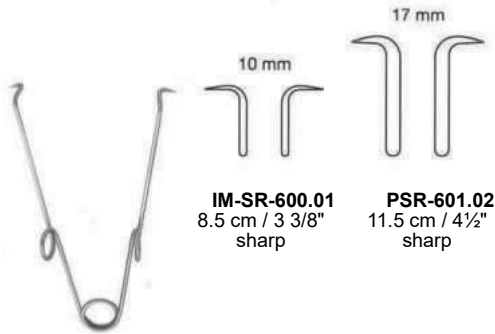

IM-SR-600.01
8.5 cm / 3 3/8"
sharp

PSR-601.02
11.5 cm / 4 1/2"
sharp

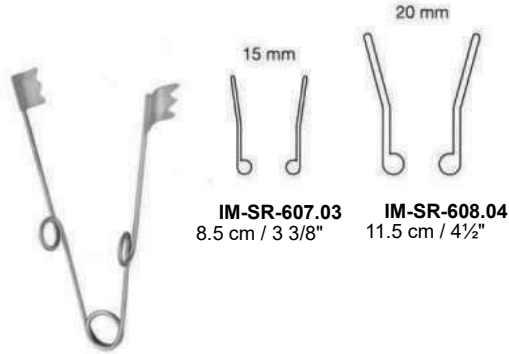

IM-SR-607.03
8.5 cm / 3 3/8"

IM-SR-608.04
11.5 cm / 4 1/2"

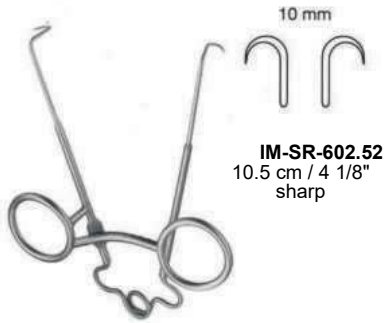

IM-SR-602.52
10.5 cm / 4 1/8"
sharp

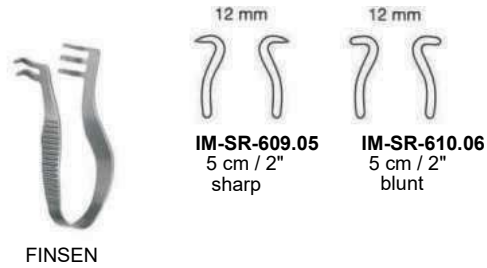

IM-SR-609.05
5 cm / 2"
sharp

IM-SR-610.06
5 cm / 2"
blunt

FINSEN



IM-SR-603.07
7 cm / 2 3/4"
sharp

IM-SR-604.08
7 cm / 2 3/4"
blunt

FINSEN

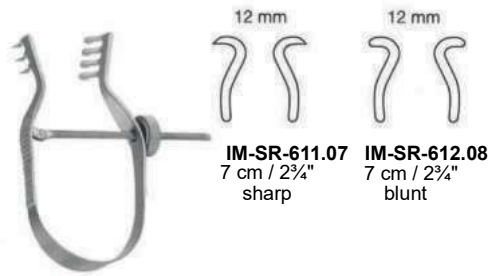

IM-SR-611.07
7 cm / 2 3/4"
sharp

IM-SR-612.08
7 cm / 2 3/4"
blunt

FINSEN

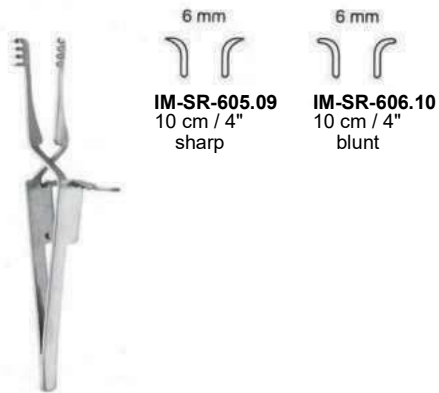

IM-SR-605.09
10 cm / 4"
sharp

IM-SR-606.10
10 cm / 4"
blunt

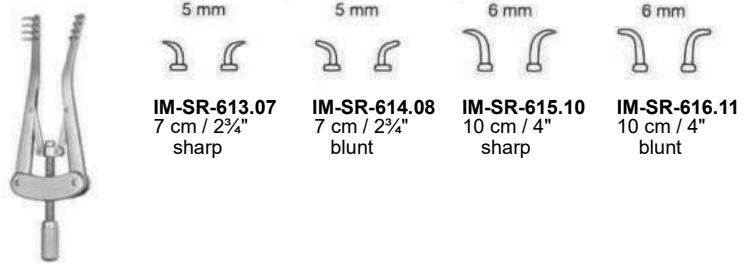

IM-SR-613.07
7 cm / 2 3/4"
sharp

IM-SR-614.08
7 cm / 2 3/4"
blunt

IM-SR-615.10
10 cm / 4"
sharp

IM-SR-616.11
10 cm / 4"
blunt

ALM

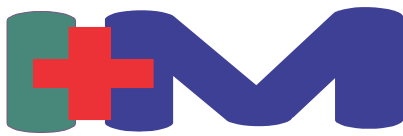

SELF-RETAINING RETRACTORS



**WEITLANER
PSR-617.13**
13 cm / 5 1/8"

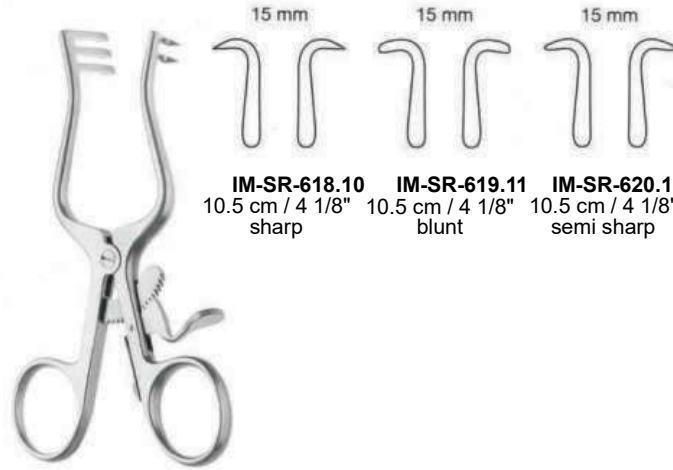

WEITLANER

IM-SR-618.10 10.5 cm / 4 1/8" sharp
IM-SR-619.11 10.5 cm / 4 1/8" blunt
IM-SR-620.12 10.5 cm / 4 1/8" semi sharp

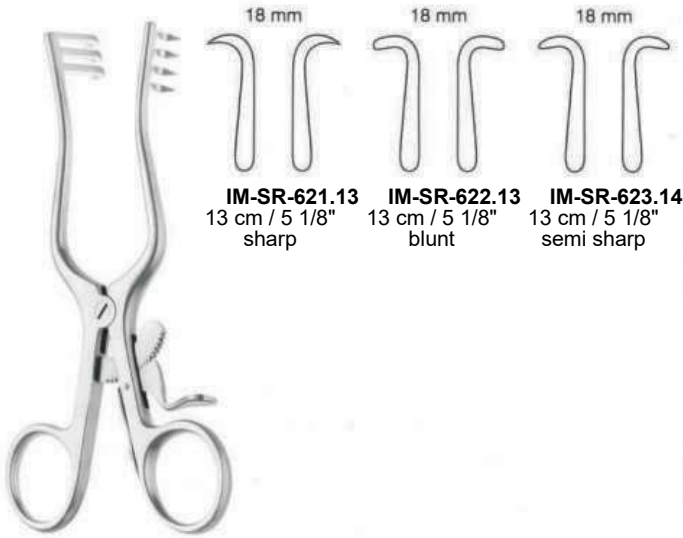

WEITLANER

IM-SR-621.13 13 cm / 5 1/8" sharp
IM-SR-622.13 13 cm / 5 1/8" blunt
IM-SR-623.14 13 cm / 5 1/8" semi sharp

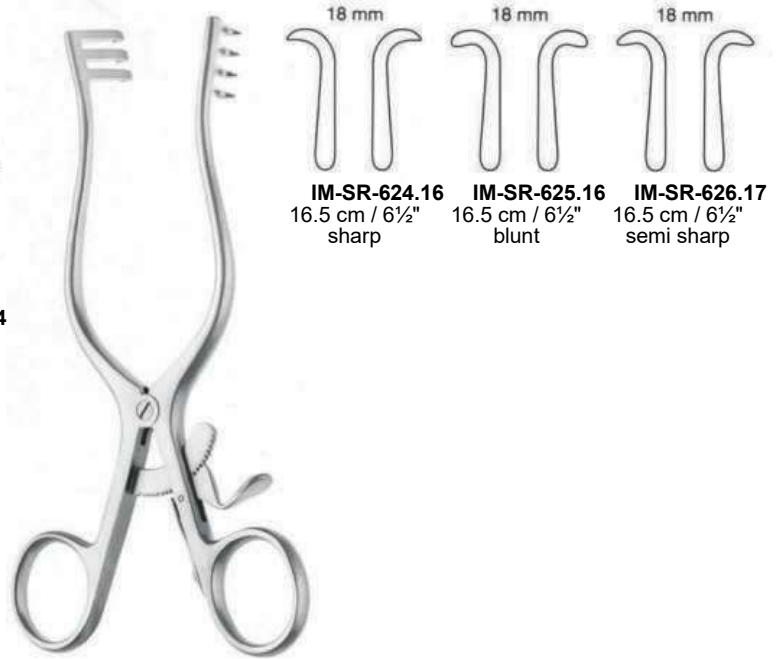

WEITLANER

IM-SR-624.16 16.5 cm / 6 1/2" sharp
IM-SR-625.16 16.5 cm / 6 1/2" blunt
IM-SR-626.17 16.5 cm / 6 1/2" semi sharp

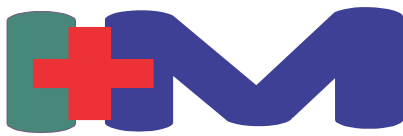

IBRAHIM MEDS

WE SERVE HUMANITY WITH EXCELLENCE

NASAL DRESSING FORCEPS



HARTMANN
IM-NDF-70.16
18 cm / 7 1/8"



HARTMANN
IM-NDF-71.20
20 cm / 8"



WESTMACOTT
20 cm / 8"

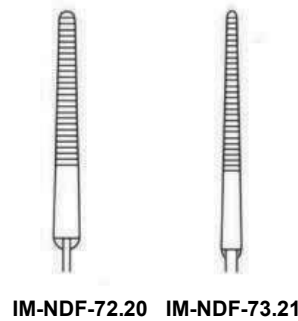

IM-NDF-72.20 IM-NDF-73.21



LUBET BARBON
IM-NDF-74.30
20 cm / 8"

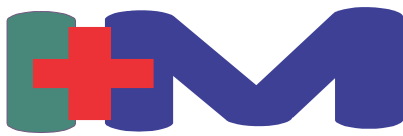

IBRAHIM MEDS

WE SERVE HUMANITY WITH EXCELLENCE

NASAL DRESSING FORCEPS



LUC BRUNINGS
(HEYMANN)
18 cm / 7 1/8"



IM-NDF-75.11



IM-NDF-76.12



CRAIG
IM-NDF-79.15
17 cm / 6 3/4"



CRAIG DOMNICK
17 cm / 6 3/4"



IM-NDF-77.16



IM-NDF-78.17



HEYMANN
IM-NDF-80.75
18 cm / 7 1/8"



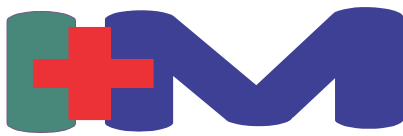

IBRAHIM MEDS

WE SERVE HUMANITY WITH EXCELLENCE

NASAL DRESSING FORCEPS



JANSEN MIDDLETON SEPTUM FORCEPS, 19CM

IM-NDF-81.19

19 cm / 7 1/2"



TILLY FORCEPS

IM-NDF-82-35

17 cm / 6 3/4"

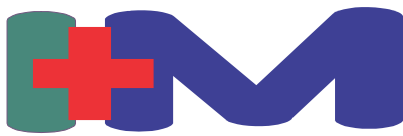

IBRAHIM MEDS

WE SERVE HUMANITY WITH EXCELLENCE

NASAL SEPTUM FORCEPS



ASCH
IM-NSF-90.21
22 cm / 8³/₄"



COTTLE FOMON
IM-NSF-92.24
21 cm / 8¹/₄"



WALSHAM "UNIVERSAL"
IM-NSF-91.21
23 cm / 9"



IM-NSF-93.22
23 cm / 9"

IM-NSF-94.23
23 cm / 9"

WALSHAM

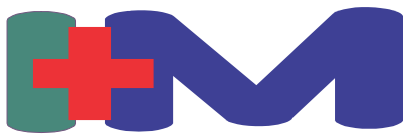

IBRAHIM MEDS

WE SERVE HUMANITY WITH EXCELLENCE

CARTILAGE & BONE FORCEPS

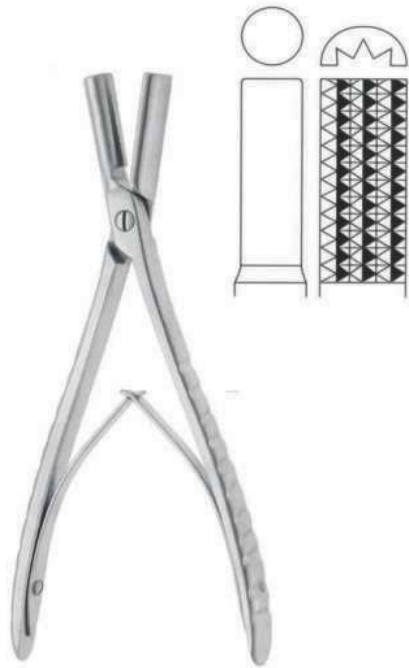

OBWEGESER
IM-CBF-50.35
17.5 cm / 7"



OBWEGESER
IM-CBF-51.36
17.5 cm / 7"

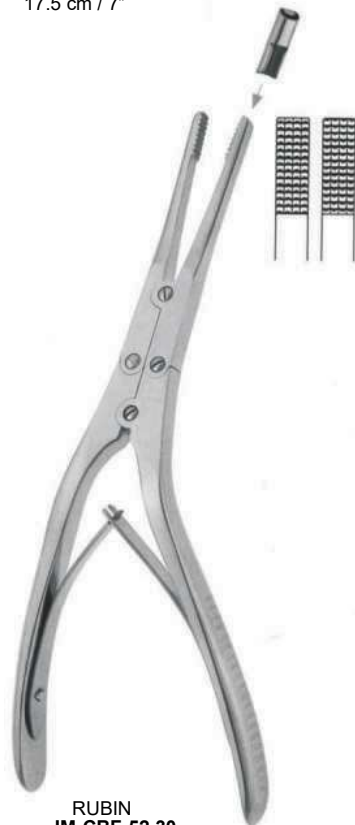

RUBIN
IM-CBF-52.30
20 cm / 8"



RUBIN
IM-CBF-53.72
20 cm / 8"

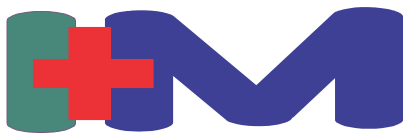

IBRAHIM MEDS

WE SERVE HUMANITY WITH EXCELLENCE

GRASPING FORCEPS & HOOK SCISSORS

Hook scissors
Tijeras de gancho
Ciseaux à crochet
Forbici a gancio

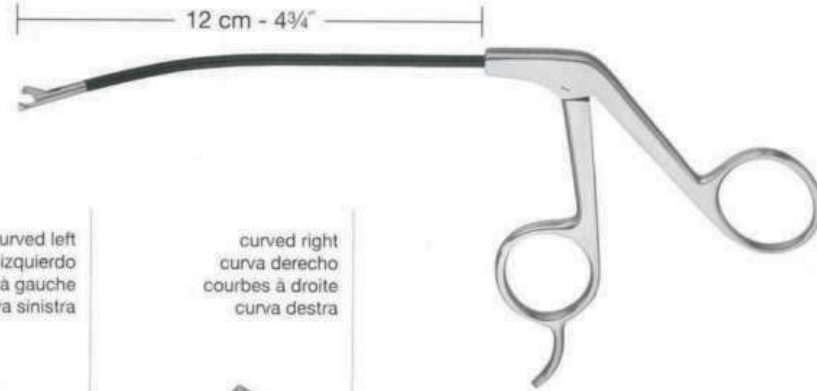

curved left
curva izquierdo
courbes à gauche
curva sinistra



IM-GF-500.15

curved right
curva derecho
courbes à droite
curva destra



IM-GF-501.16

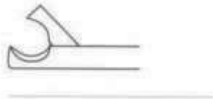

Grasping forceps
Pinzas para agarrar
Pinces à saisir
Pinze per afferrare

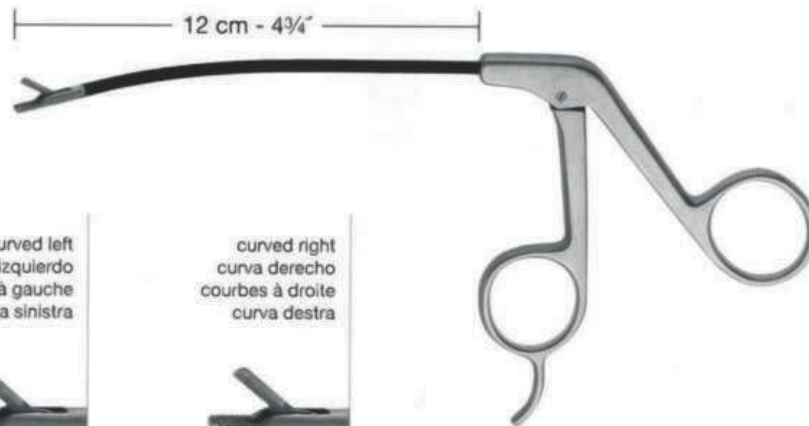

curved left
curva izquierdo
courbes à gauche
curva sinistra



IM-GF-502.17

curved right
curva derecho
courbes à droite
curva destra







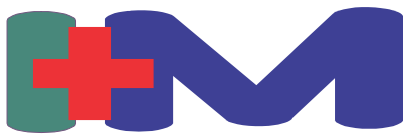









IM-GF-503.18





NASAL FORCEPS



		straight	angled upwards	angled upwards
			45°	90°
with normal shaft	3,0 mm 			
	3,6 mm 	IM-NF-600.01	IM-NF-605.11	IM-NF-610.11
	4,2 mm 	IM-NF-601.02	IM-NF-606.12	IM-NF-611.12
	4,8 mm 	IM-NF-602.03	IM-NF-607.13	IM-NF-612.13
	5,6 mm 	IM-NF-603.04	IM-NF-608.14	IM-NF-613.14
with slim shaft	3,0 mm 	IM-NF-604.05	IM-NF-609.15	IM-NF-614.15
				
	3,6 mm 	IM-NF-615.71	IM-NF-620.81	
	4,2 mm 	IM-NF-616.72	IM-NF-621.82	
	4,8 mm 	IM-NF-617.73	IM-NF-622.83	
	5,6 mm 	IM-NF-618.74	IM-NF-623.84	
		IM-NF-619.75	IM-NF-624.85	

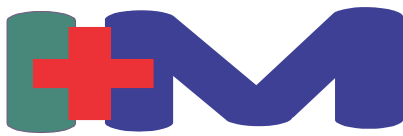

NASAL FORCEPS

11,5 cm - 4½"



6WEIL BLAKESLEY

2,0 mm



straight



IM-NF-625.25

angled upwards

45°



IM-NF-628.35

2,5 mm



IM-NF-626.27

IM-NF-629.76

3,0 mm



IM-NF-627.28

IM-NF-630.37

11,5 cm - 4½"



BLAKESLEY

straight



IM-NF-631.59

angled upwards



IM-NF-632.60

angled upwards

90°



IM-NF-633.61

3,0 mm



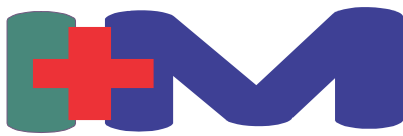

NASAL RETRACTORS



FOMON
IM-NR-700.17
17 cm / 6 3/4"



NEIVERT
IM-NR-701.19
19 cm / 7 1/2"

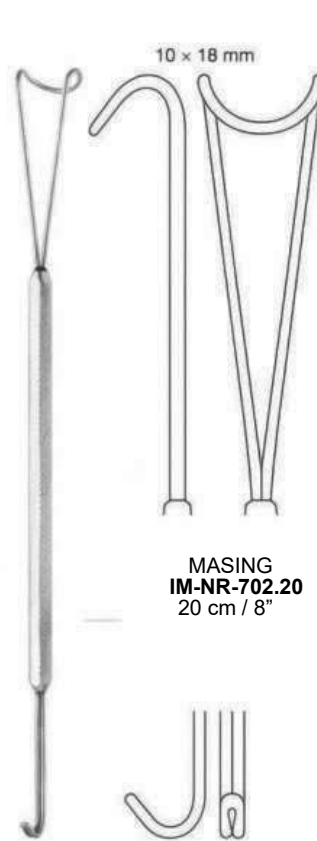

MASING
IM-NR-702.20
20 cm / 8"



COTTLE NEIVERT
IM-NR-703.21
21 cm / 8 1/4"

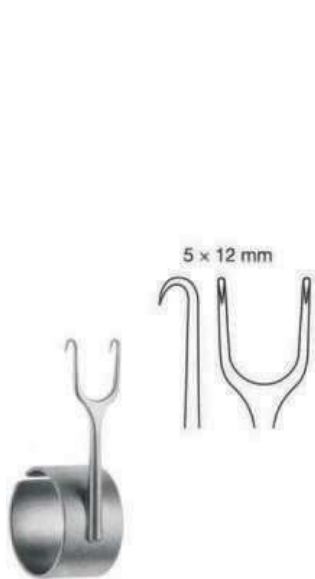

MILARD (COTTLE)
IM-NR-704.23
5.5 cm / 2 1/8"



COTTLE
IM-NR-705.44
15 cm / 6"



COTTLE
15 cm / 6"



IM-NR-706.16



IM-NR-707.16



IM-NR-708.16

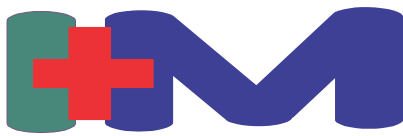

NASAL RETRACTORS



COTTLE
IM-NR-709.44
15 cm / 6"

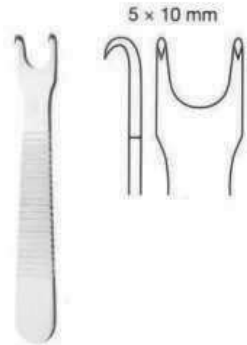

KILNER
IM-NR-710.46
10 cm / 4"

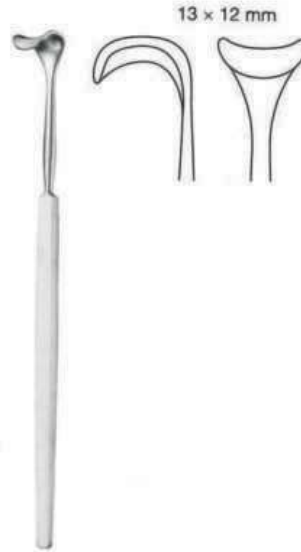

COTTLE
IM-NR-711.48
14 cm / 5½"

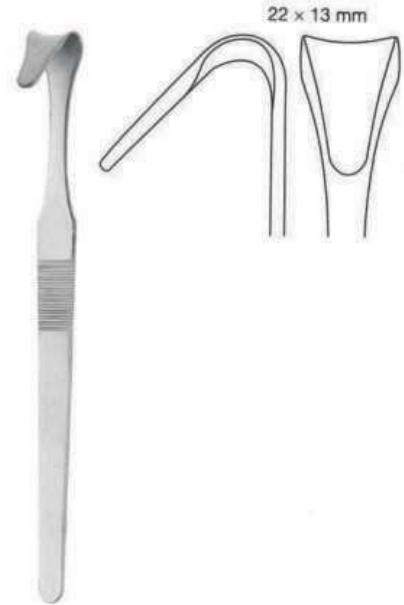

COTTLE
IM-NR-712.50
15 cm / 6"

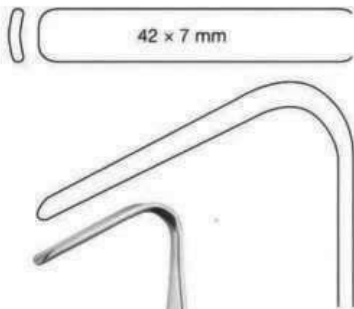

IM-NR-713.60

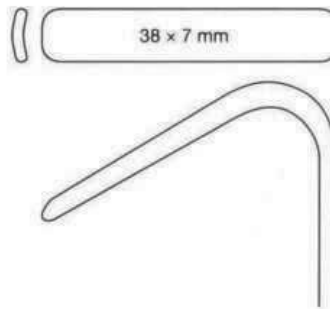

IM-NR-714.70



AUFRICHT
IM-NR-715.80
13.5 cm / 5 3/8"

AUFRICHT WALTER
13.5 cm / 5 3/8"

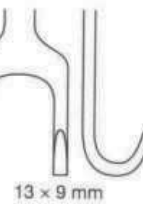
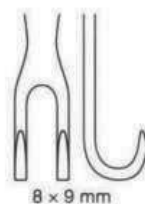
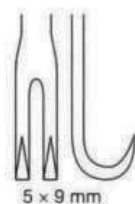

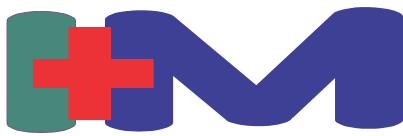

NASAL RETRACTORS



CONVERSE
IM-NR-716.12
12 cm / 4¾"

GUBISCH AUFRICHT
IM-NR-717.17
17 cm / 6¾"

AUFRICHT
IM-NR-718.19
18 cm / 7 1/8"



Aufricht Nasal Retractor 18cm, 45x7-10mm

IM-NR-719.12

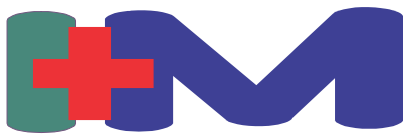

NASAL SPECULUM



HARTMANN

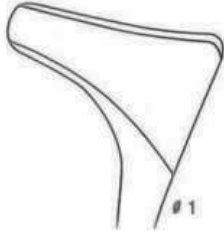

IM-NS-720.15
15 cm / 6"

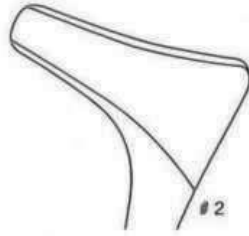

IM-NS-721.16
15 cm / 6"

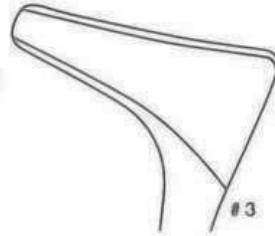

IM-NS-722.17
15 cm / 6"



TIECK HALF

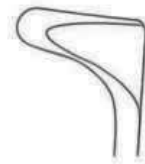

IM-NS-723.10
13.5 cm / 5 3/4"



IM-NS-724.11
13.5 cm / 5 3/4"



COTTLE

14 cm / 5 1/2"
a = 35 mm, #1 **IM-NS-725.50**
a = 55 mm, #2 **IM-NS-726.51**
a = 75 mm, #3 **IM-NS-727.52**
a = 90 mm, #4 **IM-NS-728.53**



COTTLE
IM-NS-729.60
14 cm / 5 1/2"

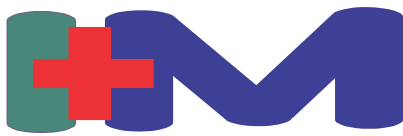

NASAL SPECULUM

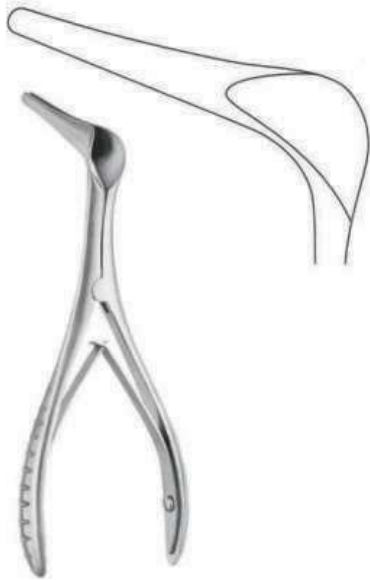

COTTLE
IM-NS-730.62
13 cm / 5 1/8"



"MOD. WIEN"

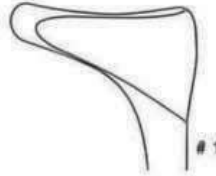

IM-NS-731.15
14 cm / 5 1/2"

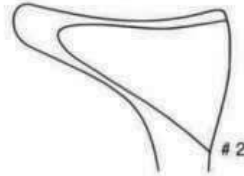

IM-NS-732.16
14 cm / 5 1/2"

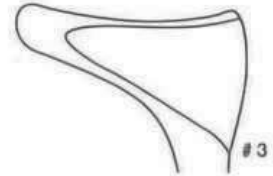

IM-NS-733.17
14 cm / 5 1/2"

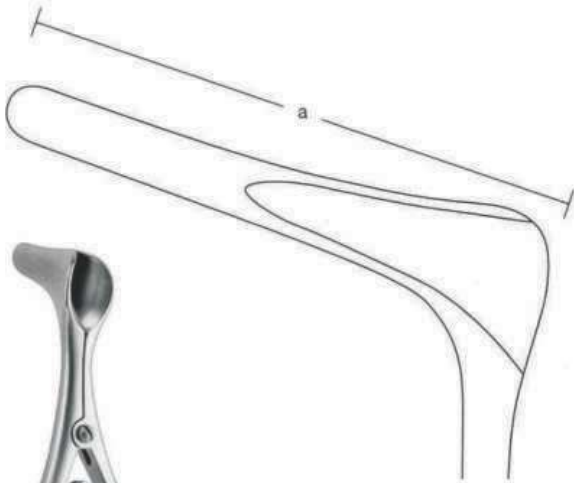

14 cm / 5 1/2"

- a = 35 mm, #1 **IM-NS-734.14**
- a = 50 mm, #2 **IM-NS-735.15**
- a = 75 mm, #3 **IM-NS-736.16**
- a = 90 mm, #4 **IM-NS-737.17**



KILLIAN

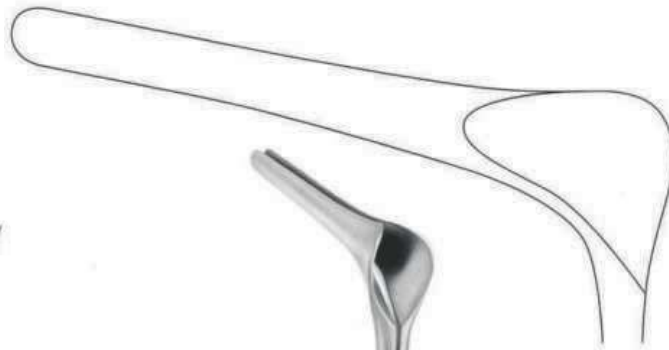

KILLIAN
IM-NS-738.59
14 cm / 5 1/2"

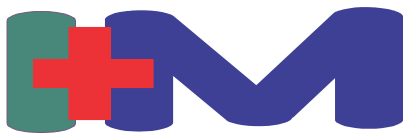

NASAL RASPS



JOSEPH
17 cm / 6 3/4"



IM-NR-200.24
left



IM-NR-201.24
right

Nasal Saws
Sierras nasales
Scies nasales
Seghe nasali



JOSEPH
PNR-202.24
17 cm / 6 3/4"



COTTLE
IM-NR-203.24
21 cm / 8 1/4"

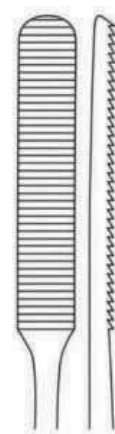

COTTLE
IM-NR-204.25
20.5 cm / 8"

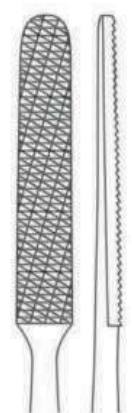

MALTZ
IM-NR-205.25
18.5 cm / 7 1/4"

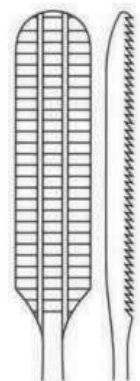

IM-NR-206.47
19.5 cm / 7 3/4"

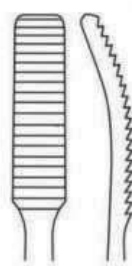

LEWIS
IM-NR-207.50
19.5 cm / 7 3/4"

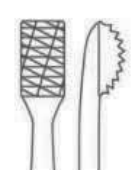



NASAL RASPS



IM-NR-208.35
15 cm / 6"
left

IM-NR-209.36
15 cm / 6"
right

CARTILAGE ABRADERS
IM-NR-210.37
Set complete (#1+2)

DINGMAN



LEWIS
IM-NR-211.26
20 cm / 8"



KISTLER



IM-NR-212.45
16 cm / 6¼"

IM-NR-213.46
16 cm / 6¼"

Anhelix Cartilage File for Auricular Plastic
Lima para el cartilago del anhelix para la otoplastia
Lime pour le cartilage de l'anthelix pour l'otoplastie
Lima per cartilagine del anhelix per l'otoplastica

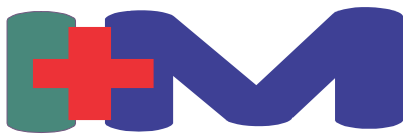

NASAL RASPS



AUFRICHT

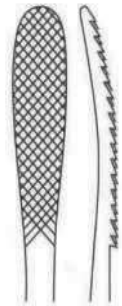

IM-NR-228.26
21 cm / 8 1/4"

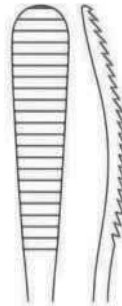

IM-NR-229.27
21 cm / 8 1/4"

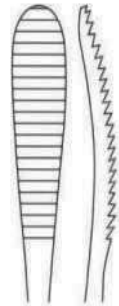

IM-NR-230.28
21 cm / 8 1/4"

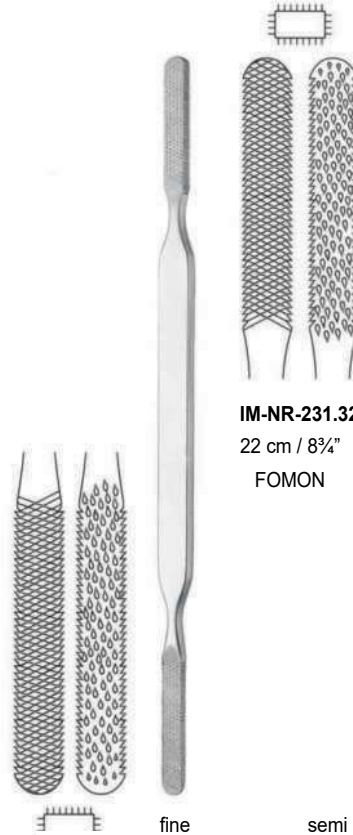

IM-NR-231.32
22 cm / 8 3/4"
FOMON

fine

fine

semi fine



OBWEGESER
19 cm / 7 1/4"

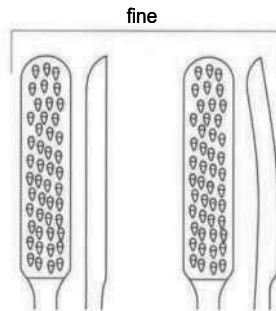

HGMR-232.41

HGMR-233.43

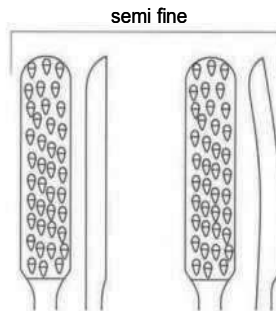

HGMR-232.42

HGMR-233.44

One working end of the rasp operates by pushing, the other by pulling.



OBWEGESER
19 cm / 7 1/4"

Bone splinters are pushed through the perforated working ends. This avoids plugging of the rasps and they can be cleaned easily.

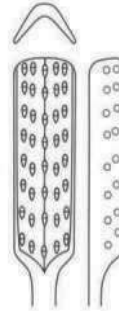

IM-NR-236.45

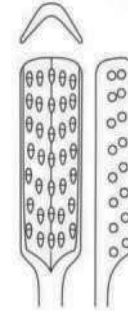

IM-NR-237.46

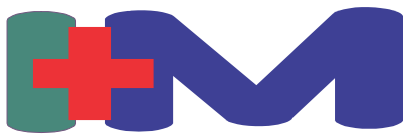

IBRAHIM MEDS

WE SERVE HUMANITY WITH EXCELLENCE

NASAL RASPS

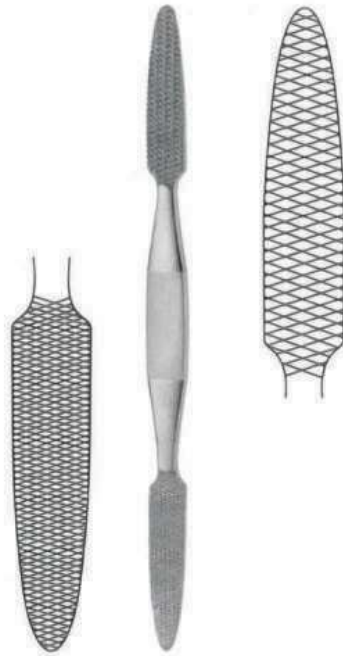

CONVERSE
IM-NR-238.65
18.5 cm / 7¼"



MASING
IM-NR-239.70
21 cm / 8¼"

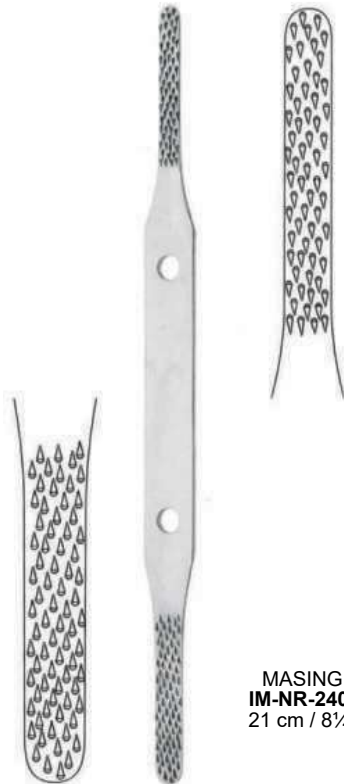

MASING
IM-NR-240.71
21 cm / 8¼"

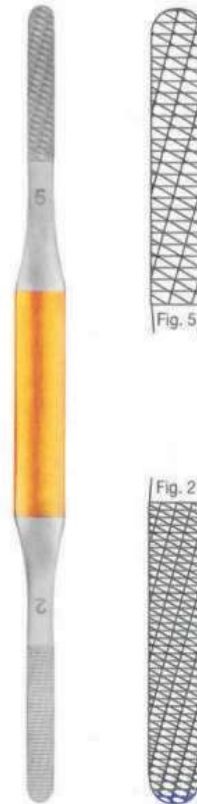

GUBISCH FOMON
IM-NR-241.30
20 cm / 8"

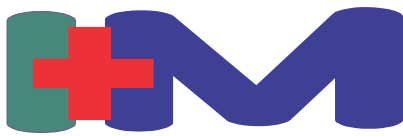

RHINOPLASTY KNIVES



COTTLE
IM-RK-100.14
14 cm / 5½"



COTTLE
IM-RK-102.14
14 cm / 5½"



JOSEPH
IM-RK-103.16
16 cm / 6¼"



CONVERSE
IM-RK-104.15
15 cm / 6"



Ballanger Swivel Knife
19 cm

IM-RK-105.19



Ballanger Swivel Knife, Bayonet
19 cm

IM-RK-106.19

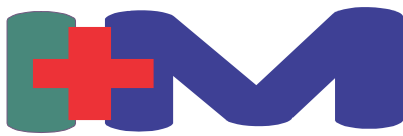

CHISELS & OSTEOTOMES

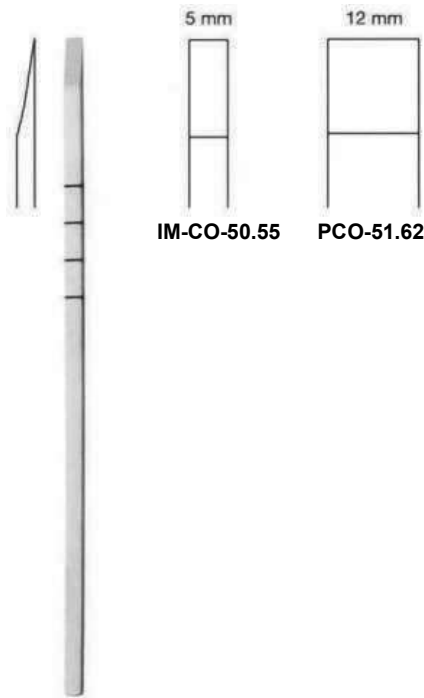

IM-CO-50.55

PCO-51.62

COTTLE GUBISCH
18 cm / 7 1/8"

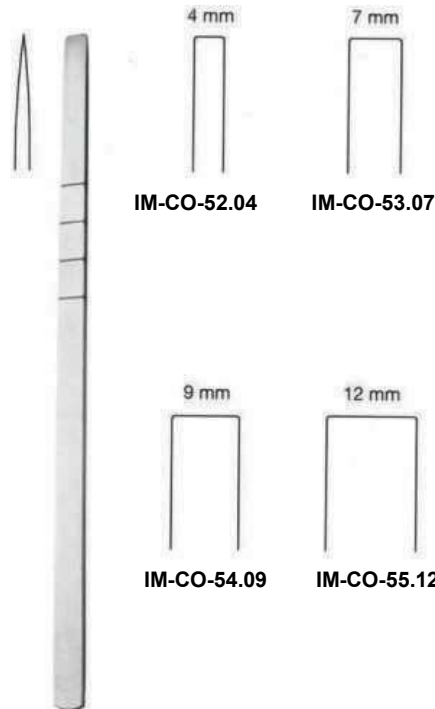

IM-CO-52.04

IM-CO-53.07

IM-CO-54.09

IM-CO-55.12

COTTLE
18 cm / 7 1/8"

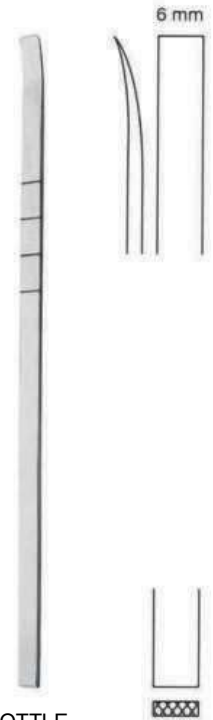

COTTLE
IM-CO-56.16
18 cm / 7 1/4"

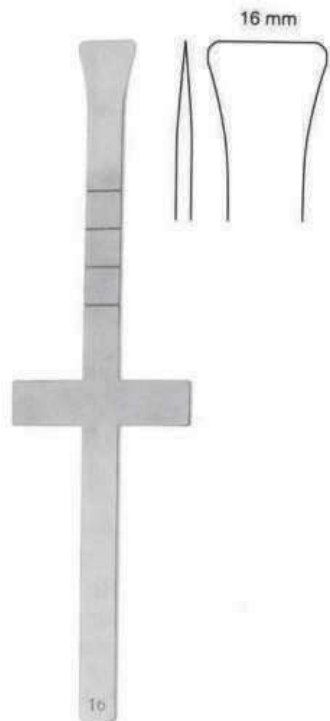

COTTLE
IM-CO-57.20
18 cm / 7 1/8"

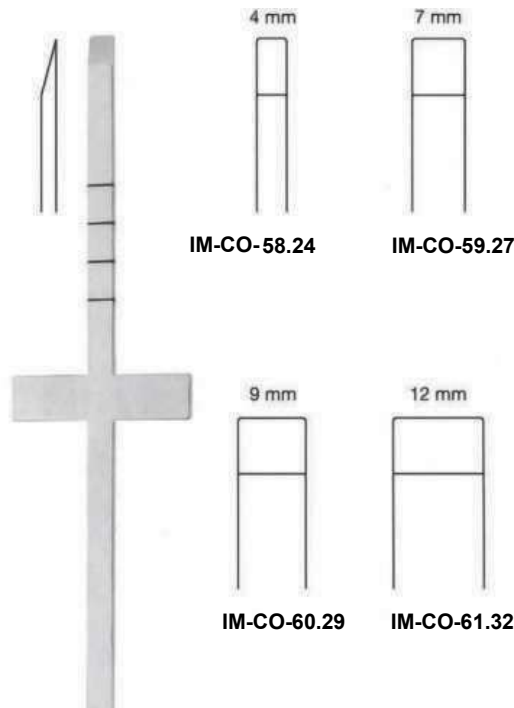

IM-CO-58.24

IM-CO-59.27

IM-CO-60.29

IM-CO-61.32

COTTLE
18 cm / 7 1/8"

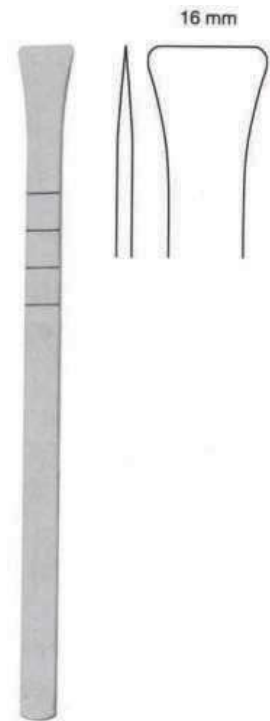

COTTLE
IM-CO-62.38
18 cm / 7 1/8"

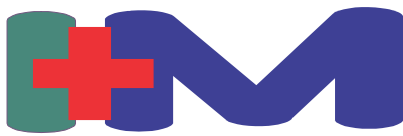

CHISELS & OSTEOTOMES



RUBIN
18 cm / 7 1/8"

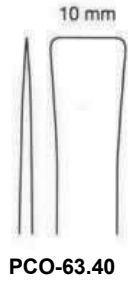

PCO-63.40

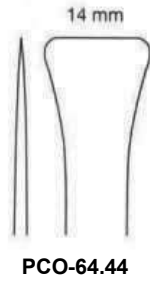

PCO-64.44

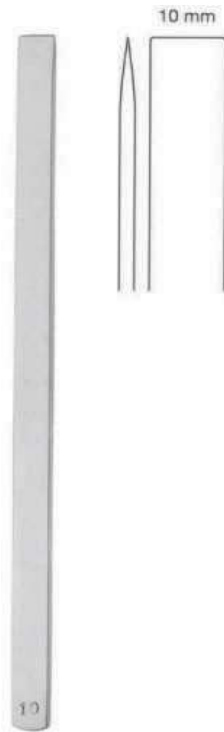

COTTLE
PCO-65.50
20 cm / 8"



FANOUS GUBISCH
PCO-66.53
19.5 cm / 7 3/4"



FANOUS
19.5 cm / 7 3/4"



IM-CO-67.54

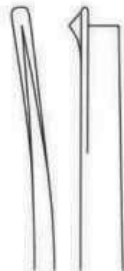

IM-CO-68.55



IM-CO-69.56



WALTER
19cm / 7 1/2"

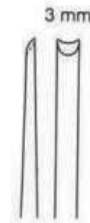

IM-CO-70.63

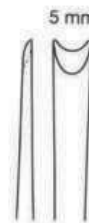

IM-CO-71.65

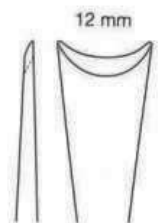

IM-CO-72.70

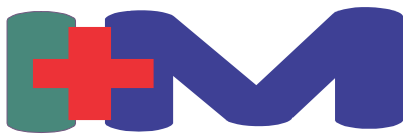

IBRAHIM MEDS

WE SERVE HUMANITY WITH EXCELLENCE

CHISELS & OSTEOTOMES

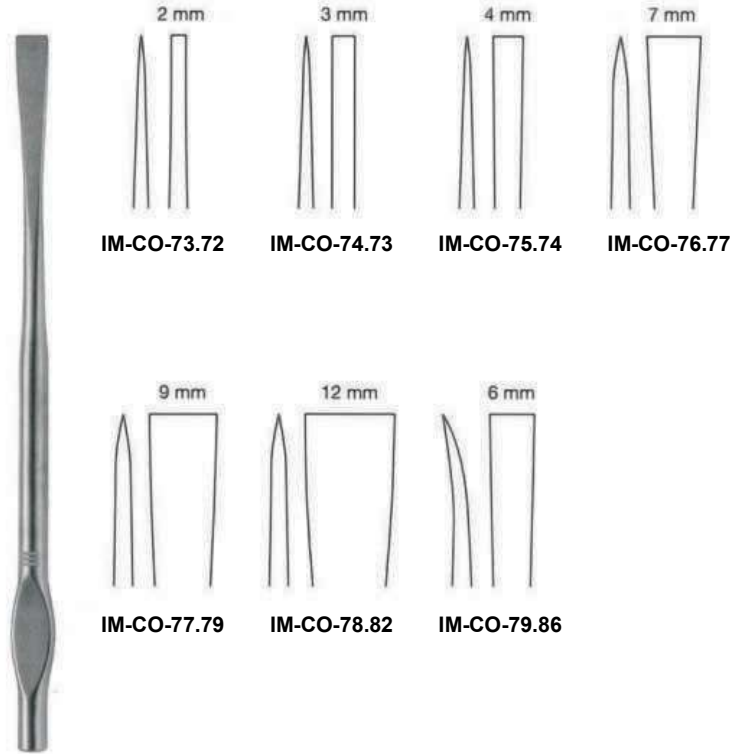

IM-CO-73.72

IM-CO-74.73

IM-CO-75.74

IM-CO-76.77

IM-CO-77.79

IM-CO-78.82

IM-CO-79.86

WALTER
19cm / 7½"

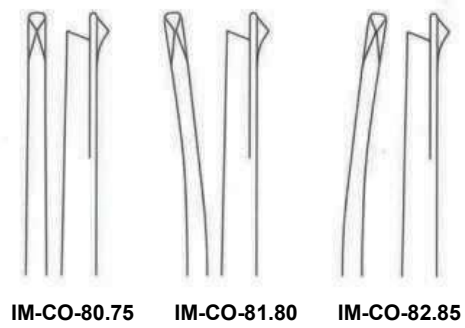

IM-CO-80.75

IM-CO-81.80

IM-CO-82.85

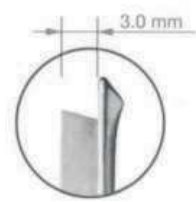

SCHROM
19.5 cm / 7¾"

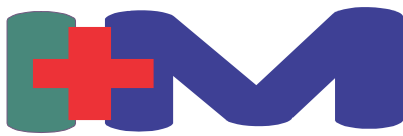

CHISELS & OSTEOTOMES

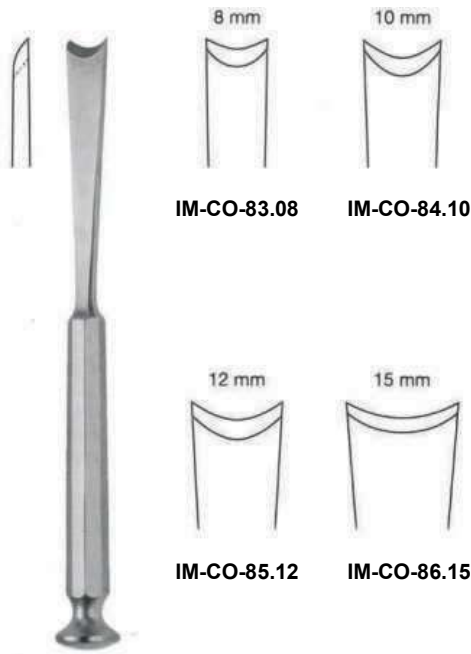

MCINDOE
16 cm / 6 1/4"

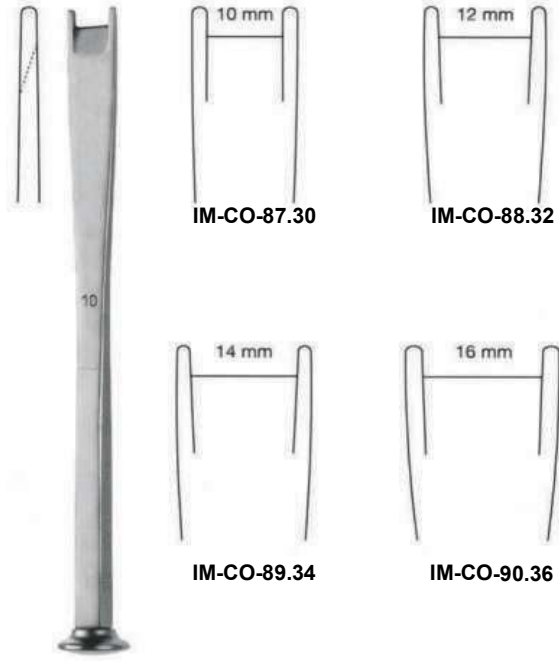

MOBERG
18 cm / 7 1/8"

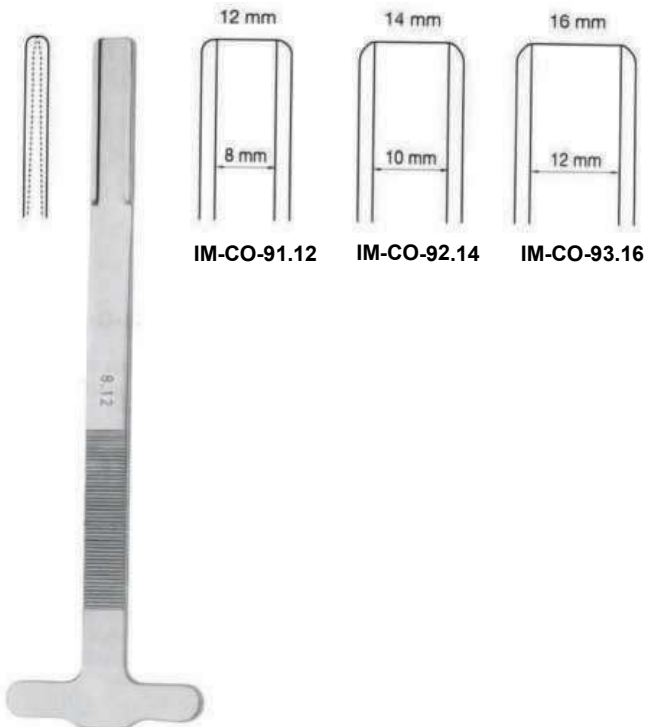

RUBIN
19 cm / 7 1/2"

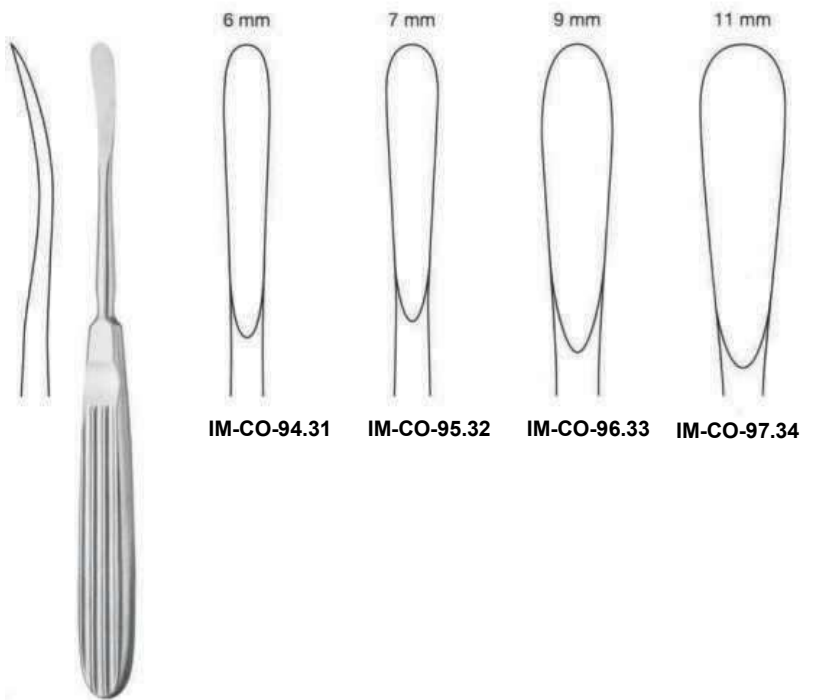

OBWEGESER
17.5 cm / 7"

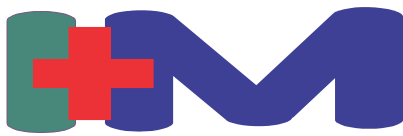

CHISELS & OSTEOTOMES



FOMON



IM-CO-98.17
17 cm / 6 3/4"

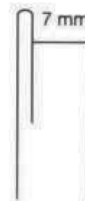

IM-CO-99.19
17 cm / 6 3/4"



IM-CO-100.20
17 cm / 6 3/4"



SILVER
18 cm / 7 1/8"



IM-CO-101.01

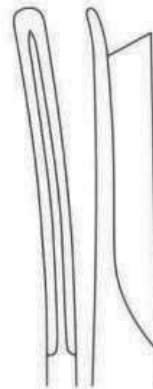

IM-CO-102.02

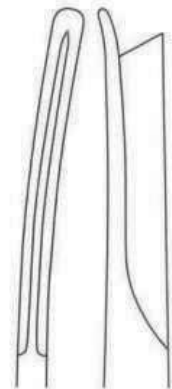

IM-CO-103.03



CINELLI
16 cm / 6 1/4"



IM-CO-104.10



IM-CO-105.12



IM-CO-106.14



IM-CO-107.16



BLUME
IM-CO-108.20
18 cm / 7 1/8"

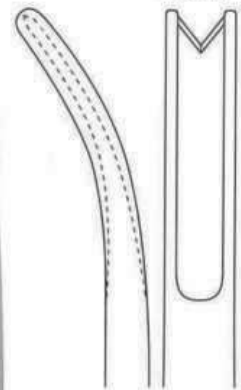

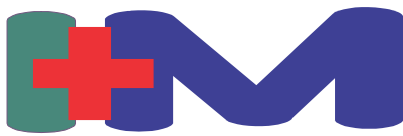

CHISELS & OSTEOTOMES



GUBISCH
IM-CO-109.53
18.5 cm / 7 1/4"



OBWEGESER
15 cm / 6"

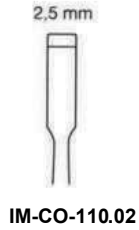

IM-CO-110.02

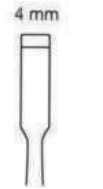

IM-CO-111.04



IM-CO-112.39



OBWEGESER
22 cm / 8 3/4"

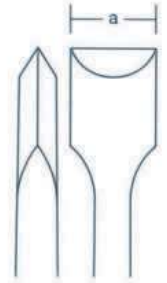

a = 8 mm
a = 12 mm
a = 16 mm

IM-CO-113.12
IM-CO-114.13
IM-CO-115.14



OBWEGESER
21.5 cm / 8 1/2"

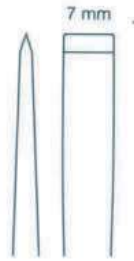

IM-CO-116.07

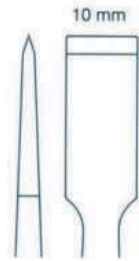

IM-CO-117.10



OBWEGESER
22 cm / 8 3/4"

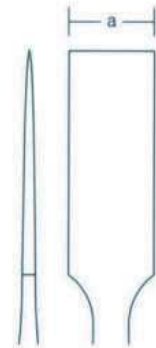

a = 8 mm
a = 12 mm
a = 16 mm
a = 20 mm

IM-CO-118.16
IM-CO-119.17
IM-CO-120.18
IM-CO-121.20

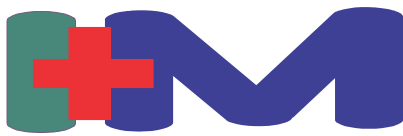

CHISELS & OSTEOTOMES

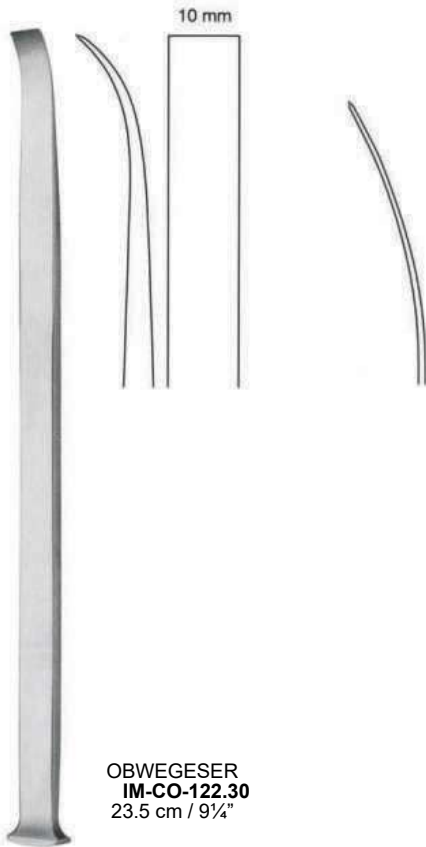

OBWEGESER
IM-CO-122.30
23.5 cm / 9 1/4"



IM-CO-123.34



8 mm



10 mm

IM-CO-124.35



a = 10 mm
a = 15 mm
a = 20 mm
a = 30 mm

TESSIER
20.5 cm / 8"

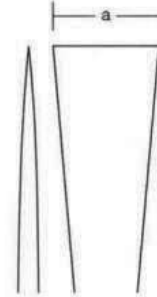

IM-CO-125.50
IM-CO-126.52
IM-CO-127.54
IM-CO-128.56

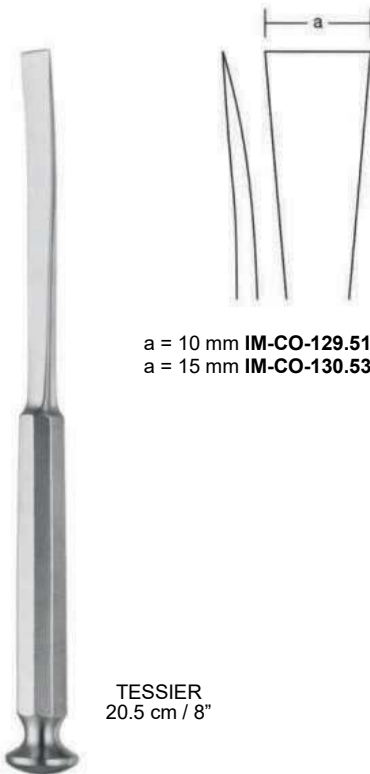

a = 10 mm IM-CO-129.51
a = 15 mm IM-CO-130.53

TESSIER
20.5 cm / 8"



TESSIER
16 cm / 6 1/4"



10 mm

IM-CO-131.60

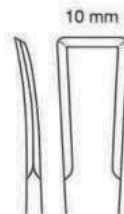

10 mm

IM-CO-132.61

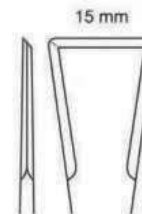

15 mm

IM-CO-133.62

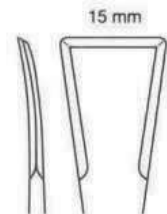

15 mm

IM-CO-134.63

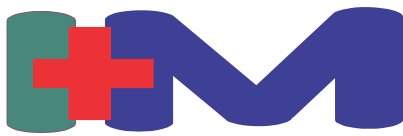

CHISELS & OSTEOTOMES



OBWEGESER
IM-CO-135.29
11 cm / 9"

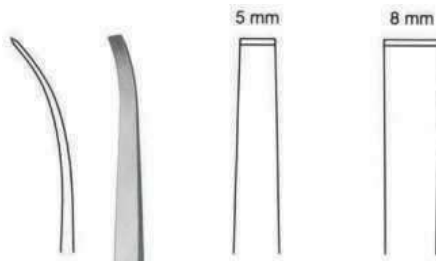

IM-CO-136.87 IM-CO-137.88



STEINHAUSER
22.5 cm / 9"



OBWEGESER
18.5 cm / 7 1/4"

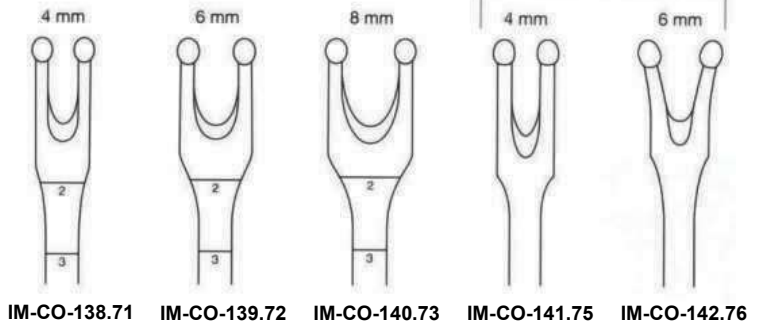

IM-CO-138.71 IM-CO-139.72 IM-CO-140.73 IM-CO-141.75 IM-CO-142.76

Maxilla Mobilizer
Movilizador maxilar
Mobilisateur pour maxillaire
Mobilizzatore per mascella

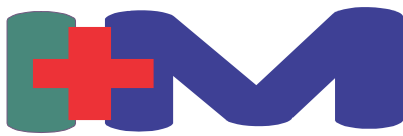

CHISELS & ELEVATORS

Mucosa knife

Cuchillo para mucosa
Septotome
Cotello per mucosa



FREER
IM-CE-200.16
16 cm / 6 1/4"



BALLENGER
16 cm / 6 1/4"

4 mm



IM-CE-201.16

6 mm



IM-CE-202.17



FREER
15.5 cm / 6 1/8"

4 mm



IM-CE-203.16

6 mm



IM-CE-204.17



KILLIAN
IM-CE-205.46
17.5 cm / 7"

6 mm



KILLIAN CLAU
IM-CE-206.47
17 cm / 6 3/4"

6 mm



IM-CE-207.50
20 cm / 8"

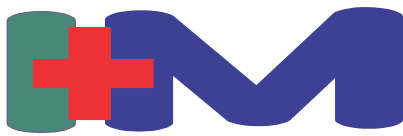

ELEVATORS

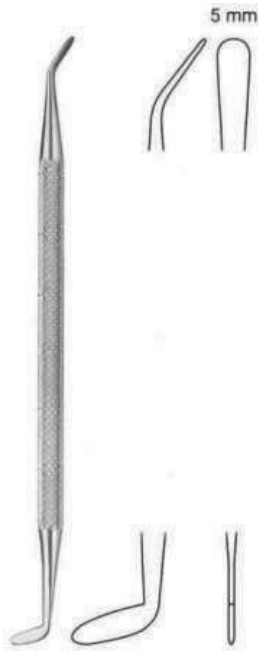

NAGATA
IM-E-300.26
16 cm / 6 1/4"

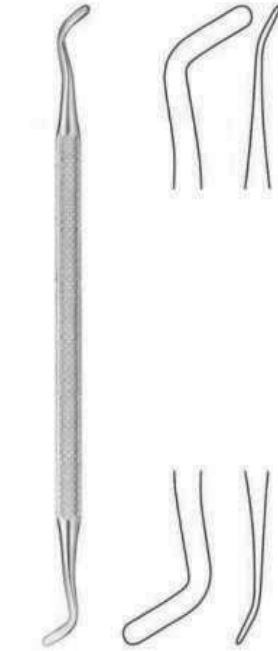

NAGATA
IM-E-301.27
17 cm / 6 3/4"



LANGENBECK
IM-E-302.04
23 cm / 9"

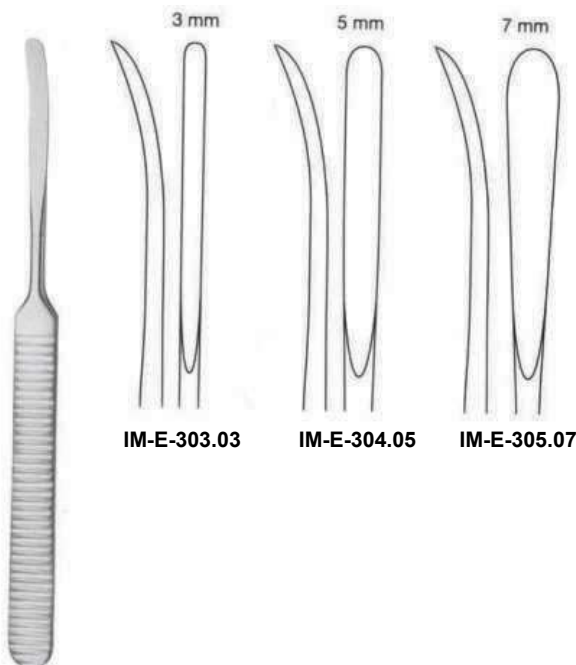

IM-E-303.03

IM-E-304.05

IM-E-305.07

WILLIGER
16 cm / 6 1/4"



IM-E-306.04

MCKENTY
15 cm / 6"



IM-E-307.05



FREER
IM-E-308.01
19 cm / 7 1/2"

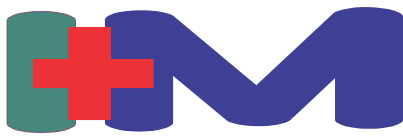

IBRAHIM MEDS

WE SERVE HUMANITY WITH EXCELLENCE

ELEVATORS

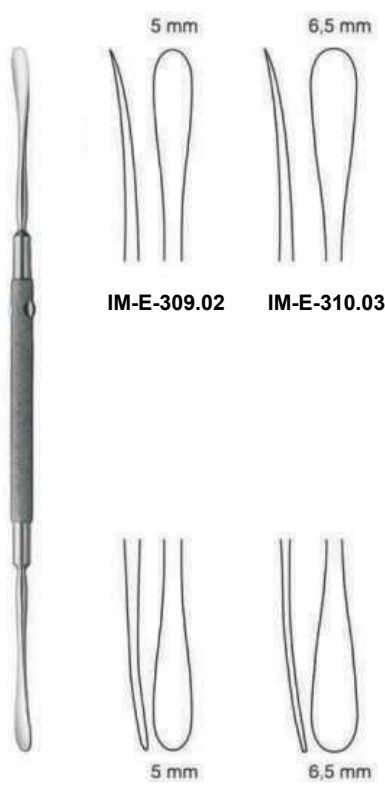

IM-E-309.02

IM-E-310.03

FREER
19 cm / 7½"

Raspatories
Legras
Rugines
Periostotomi



COHEN
PE-311.24
24 cm / 9½"



WALTER
IM-E-312.38
14.5 cm / 5¾"



WILLIGER WALTER
IM-E-313.14
14 cm / 5½"



LEMPERT
17 cm / 6¾"

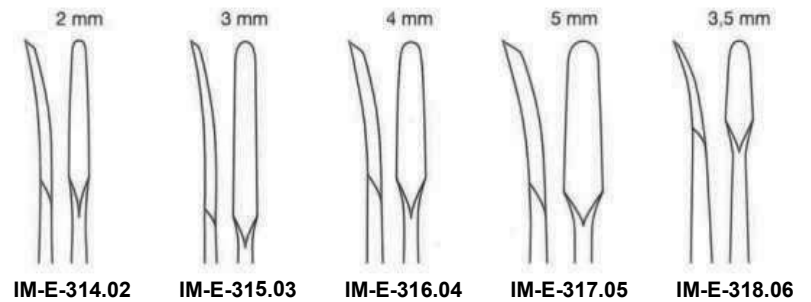

IM-E-314.02

IM-E-315.03

IM-E-316.04

IM-E-317.05

IM-E-318.06

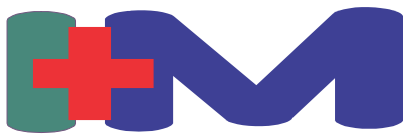

RASPATORIES & ELEVATORS



IM-RE-600.65

30 cm / 11 3/4"

IM-RE-601.66

30 cm / 11 3/4"



OBWEGESER

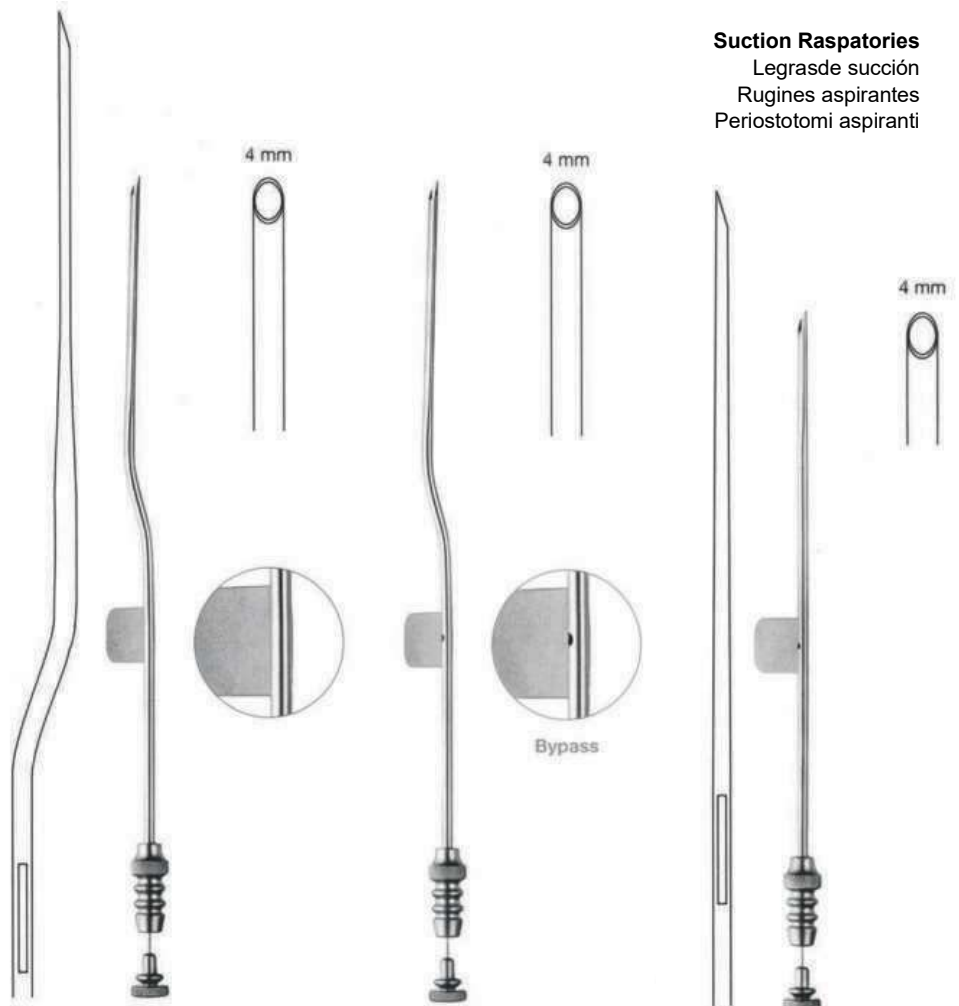

Suction Raspatories

Legrasde succión
Rugines aspirantes
Periostotomi aspiranti

IM-RE-602.93
20 cm / 8"

GUBISCH
IM-RE-603.94
20 cm / 8"

GUBISCH
IM-RE-604.97
17cm / 6 3/4"

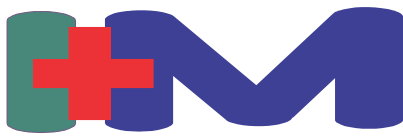

RASPATORIES & ELEVATORS



COTTLE
IM-RE-605.19
18 cm / 7 1/8"



COTTLE
IM-RE-606.20
18 cm / 7 1/8"

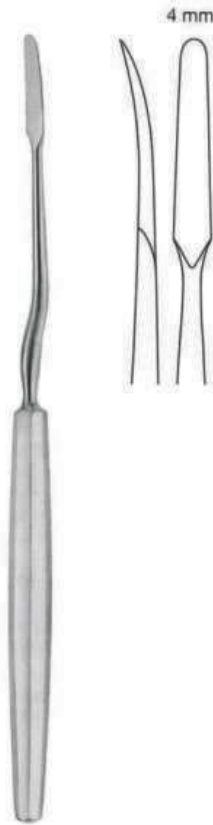

JOSEPH MASING
IM-RE-607.48
22 cm / 8 3/4"



IM-RE-608.55
18 cm / 7 1/8"

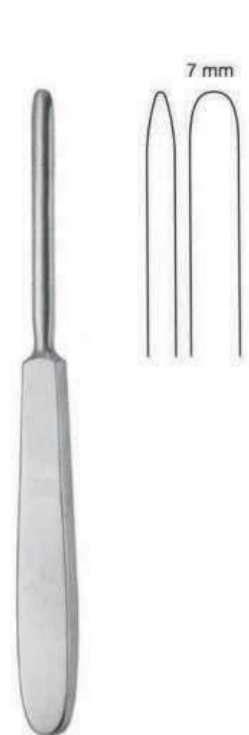

IM-RE-609.60
17 cm / 6 3/4"



CONVERSE
IM-RE-610.65
18 cm / 7 1/8"

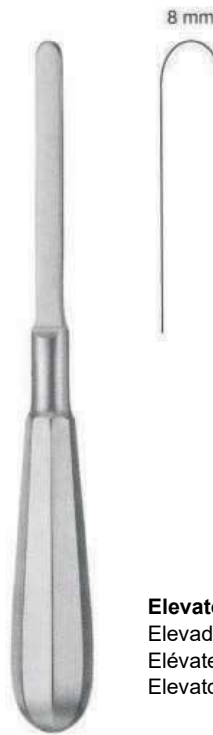

BOIES
IM-RE-611.69
19 cm / 7 1/2"



GOLDMAN
IM-RE-612.75
17 cm / 6 3/4"

Elevators
Elevadores
Elévateurs
Elevatori

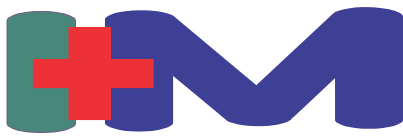

IBRAHIM MEDS

WE SERVE HUMANITY WITH EXCELLENCE

RASPATORIES & ELEVATORS

Mucosa knife and Raspatories

Cuchillo para mucosa y legbras

Septotome et rugines

Cotello per mucosa e periostotomi

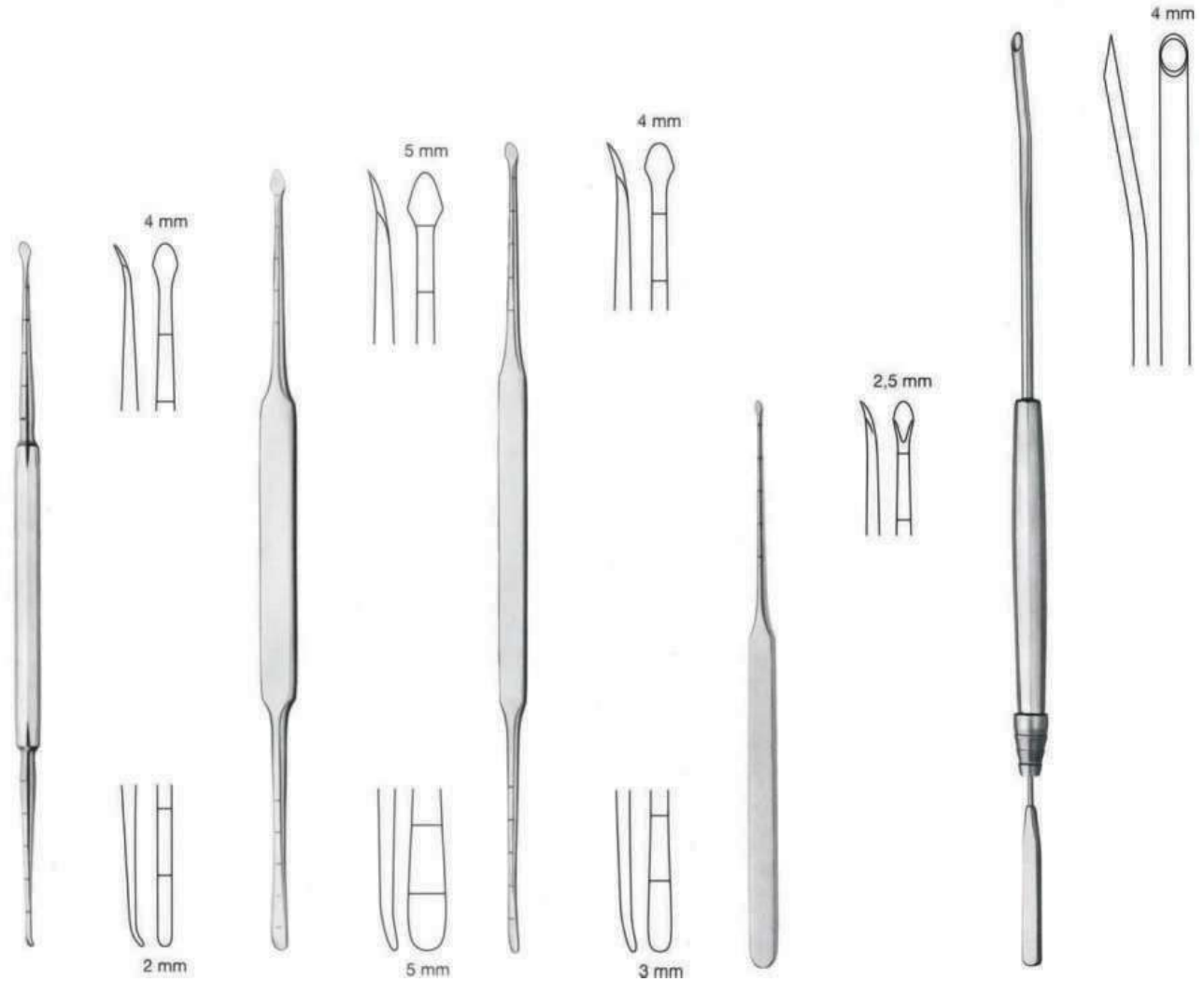

COTTLE
IM-RE-613.20
20 cm / 8"

MASING
IM-RE-614.22
22 cm / 8¾"

MASING
IM-RE-615.23
23 cm / 9"

COTTLE
IM-RE-616.12
16 cm / 6¼"

IM-RE-617.21
21 cm / 8¼"

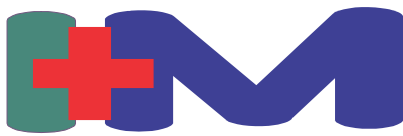

IBRAHIM MEDS

WE SERVE HUMANITY WITH EXCELLENCE

RASPATORIES & ELEVATORS

Elevators
Elevadores
Elévateurs
Elevatori

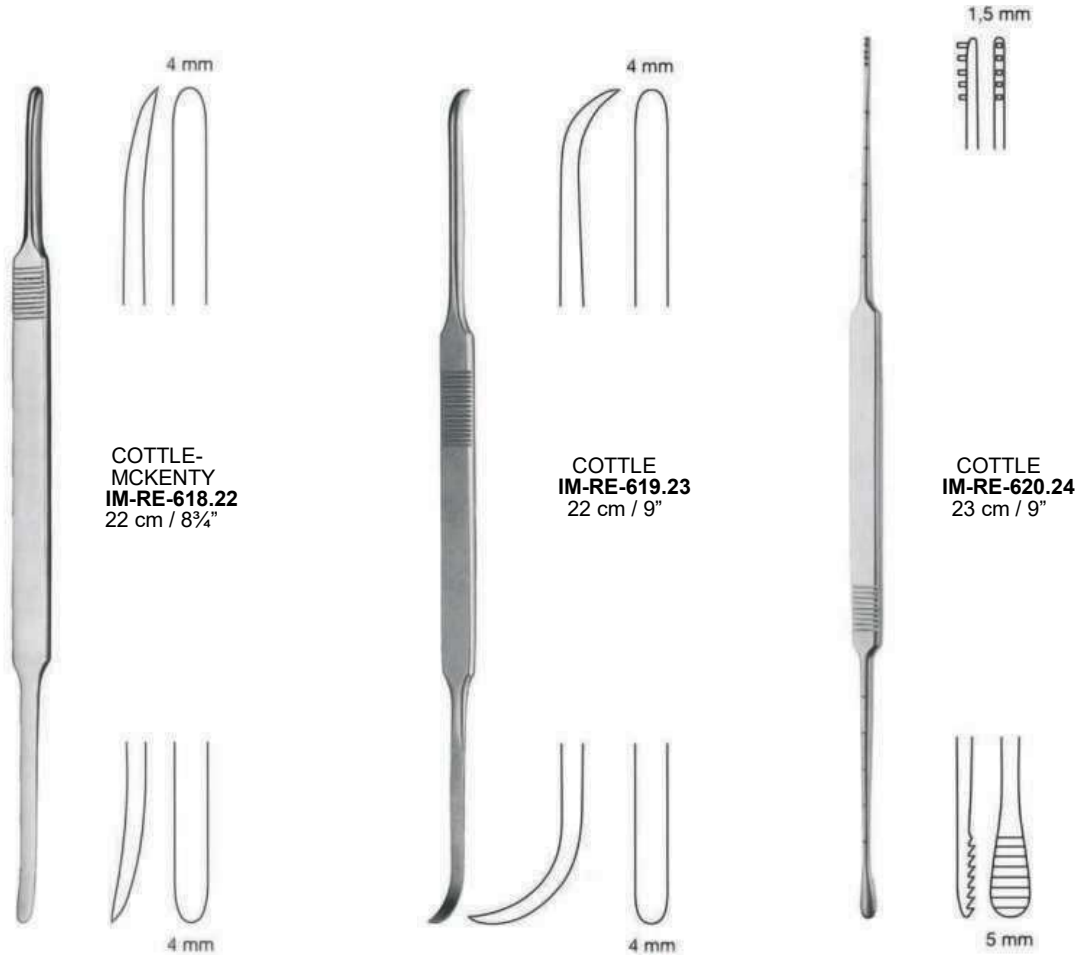

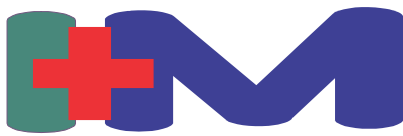

RASPATORIES & ELEVATORS



HARGIS
IM-RE-621.35
19 cm / 7½"



OBWEGESER
18 cm / 7 1/8"



IM-RE-622.36



IM-RE-623.37



OBWEGESER
IM-RE-624.38
17.5 cm / 7"

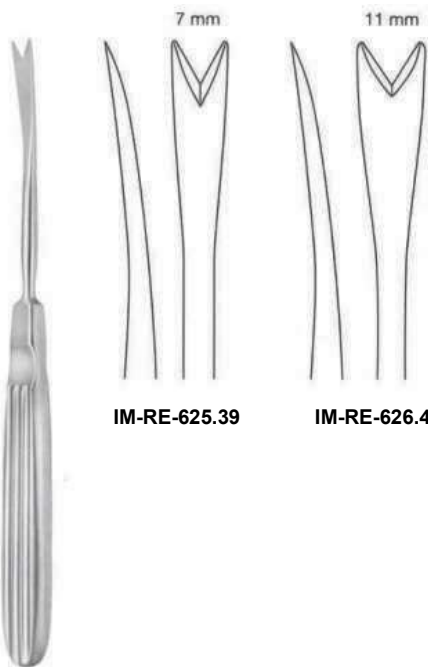
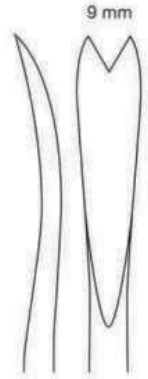

IM-RE-625.39

IM-RE-626.40



OBWEGESER
20 cm / 8"

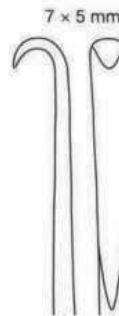

IM-RE-627.41



IM-RE-628.42

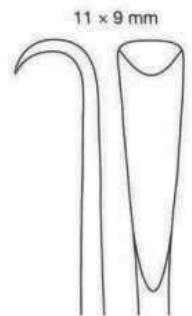

IM-RE-629.43

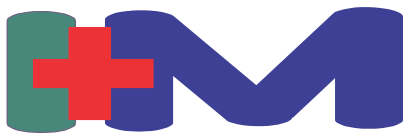

IBRAHIM MEDS

WE SERVE HUMANITY WITH EXCELLENCE

RASPATORIES & ELEVATORS

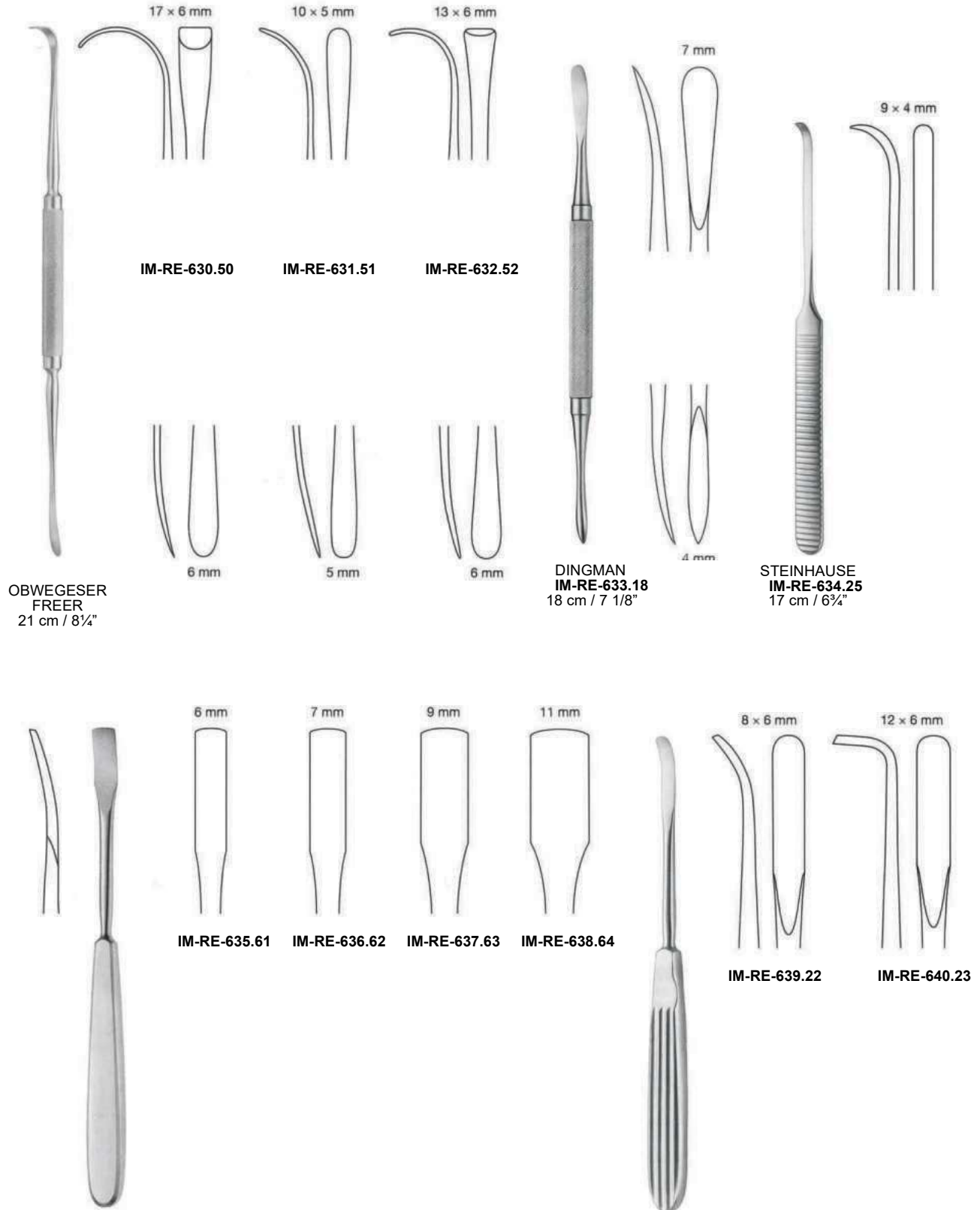

OBWEGESER
FREER
21 cm / 8 1/4"

IM-RE-630.50

IM-RE-631.51

IM-RE-632.52

DINGMAN
IM-RE-633.18
18 cm / 7 1/8"

STEINHAUSE
IM-RE-634.25
17 cm / 6 3/4"

OBWEGESER
18 cm / 7 1/8"

TESSIER
18 cm / 7 1/8"

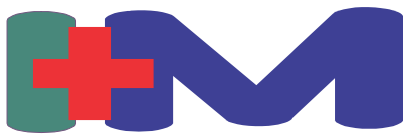

RASPATORIES & ELEVATORS



IM-RE-641.03 IM-RE-642.05

25 cm / 10"



IM-RE-643.04

IM-RE-644.06



25 cm / 10"

Dissectors
Disectores
Dissecteurs
Dissettori

IM-RE-645.08
25 cm / 10"



IM-RE-646.09
25 cm / 10"

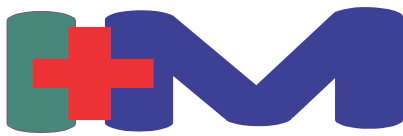

RASPATORIES & ELEVATORS



IM-RE-647.11
20 cm / 8"



IM-RE-648.12
20 cm / 8"

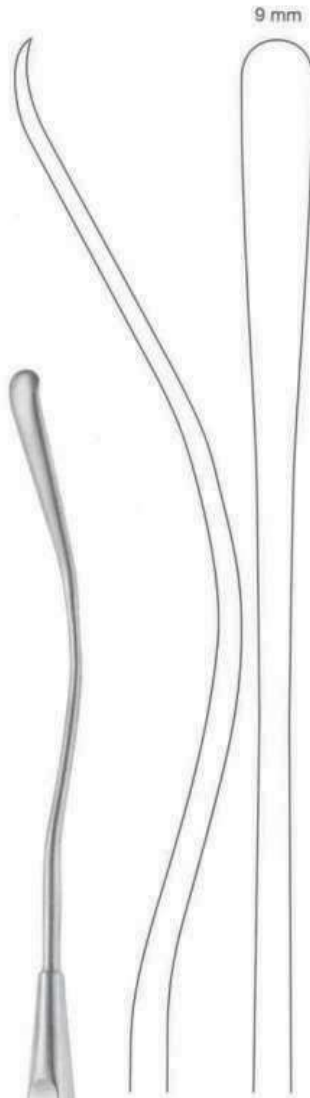

9 mm

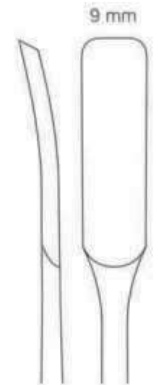

9 mm



a



a = 7 cm - 2¾"
IM-RE-649.07

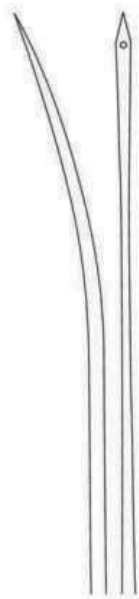

a = 12 cm - 4¾"
PRE-650.12



Elevators
Elevadores
Elévateurs
Elevatori

IM-RE-651.43
27 cm / 10"



IM-RE-652.45
27.5 cm / 10¾"

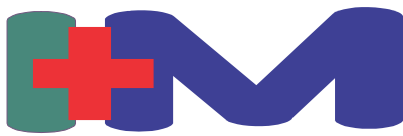

IBRAHIM MEDS

WE SERVE HUMANITY WITH EXCELLENCE

RASPATORIES & ELEVATORS



IM-RE-653.47
27.5 cm / 10 $\frac{3}{4}$ "

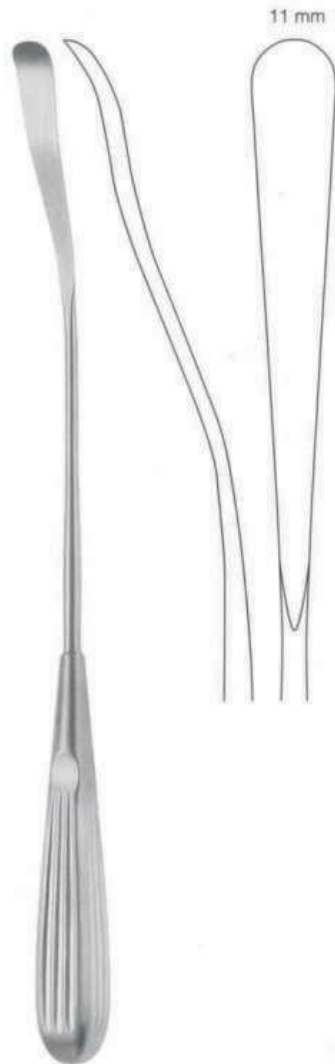

IM-RE-654.49
27.5 cm / 10 $\frac{3}{4}$ "



IM-RE-655.51
27.5 cm / 10 $\frac{3}{4}$ "

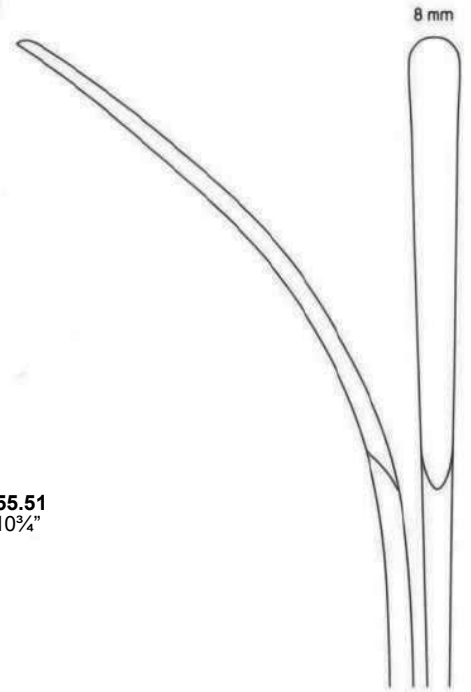

IM-RE-656.53
25.5 cm / 10"

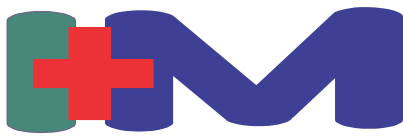

IBRAHIM MEDS

WE SERVE HUMANITY WITH EXCELLENCE

RASPATORIES & ELEVATORS

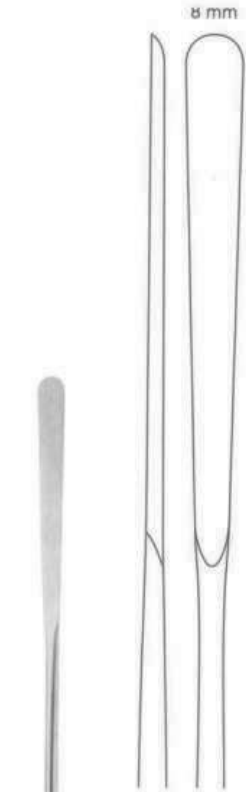

IM-RE-657.54
28 cm / 11"

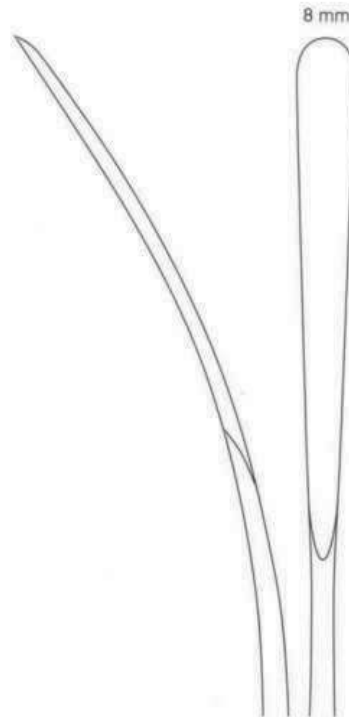

IM-RE-658.55
28 cm / 11"



Tubing connection
Empalme de tubo
Embout de tuyaux
Attacco di tubo

IM-RE-660.59
27.5 cm / 10 $\frac{3}{4}$ "

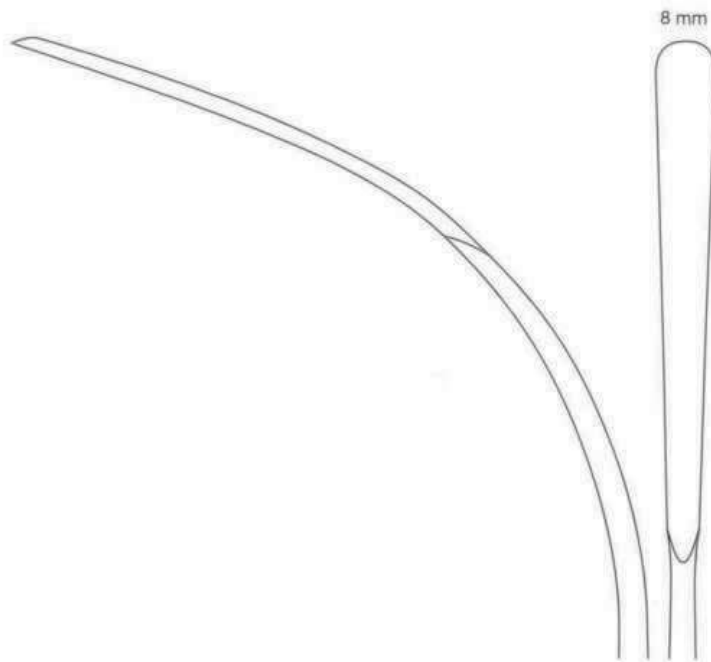

IM-RE-659.57
24 cm / 9 $\frac{1}{2}$ "

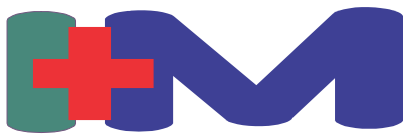

IBRAHIM MEDS

WE SERVE HUMANITY WITH EXCELLENCE

CARTILAGE & BONE INSTRUMENTS

Bone mill with assembling wrench
Trituradora de hueso con llave de montaje
Moulin à os avec clé de montage
Trita ossa con chiave per montaggio



65 x 30 x 30 mm

COTTLE
IM-CBI-800.70



IM-CBI-801.75
Ø 68 x 110 mm

Enables crushing of compact bone pieces
Permite moler fragmentos óseos
Pour broyage des fragments d'os
Rende possibile triturare frammenti ossei



65 x 30 mm

GUBISCH
IM-CBI-802.01



85 x 55 x 10 mm

IM-CBI-803.75



IBRAHIM MEDS

WE SERVE HUMANITY WITH EXCELLENCE

LIP & CLEFT PLATE INSTRUMENTS



WANG
18 cm / 7 1/8"

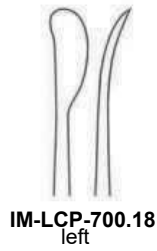

IM-LCP-700.18
left

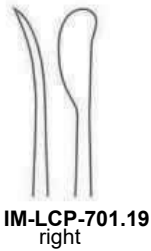

IM-LCP-701.19
right



WANG
18 cm / 7 1/8"

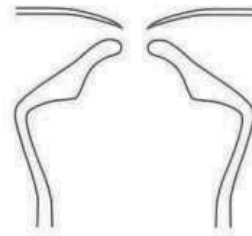

IM-LCP-702.28
left



IM-LCP-703.29
right



LANGENBECK
20 cm / 8"



IM-LCP-704.08

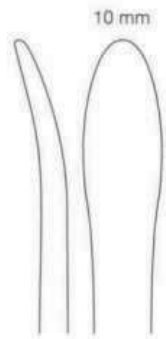

IM-LCP-705.10

Elevators
Elevadores
Elévateurs
Elevatori

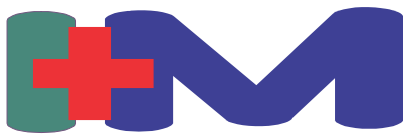

IBRAHIM MEDS

WE SERVE HUMANITY WITH EXCELLENCE

LIP & CLEFT PLATE INSTRUMENTS



BLOCKSMA
18 cm / 7 1/8"

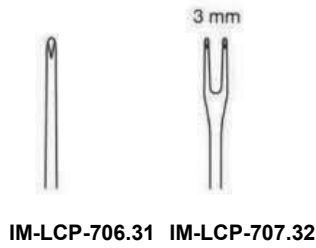

IM-LCP-706.31 **IM-LCP-707.32**



14 cm / 5 1/2"

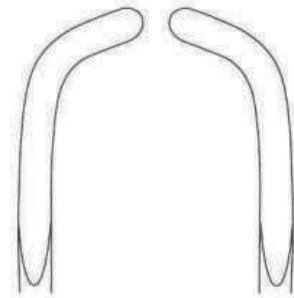

IM-LCP-708.11
left

IM-LCP-709.12
right



KAHERE
IM-LCP-710.20
17 cm / 6 3/4"



MCINDOE
IM-LCP-711.25
16.5 cm / 6 1/2"



WANG
IM-LCP-712.80
15.5 cm / 6 1/8"

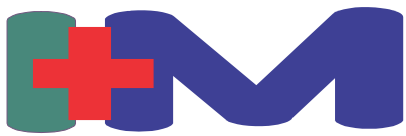

IBRAHIM MEDS

WE SERVE HUMANITY WITH EXCELLENCE

LIP & CLEFT PLATE INSTRUMENTS



IM-LCP-713.35
19 cm / 7½"



IM-LCP-715.36
19 cm / 7½"



IM-LCP-714.37
19 cm / 7½"

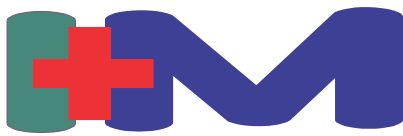

LIP & CHEEK RETRACTORS

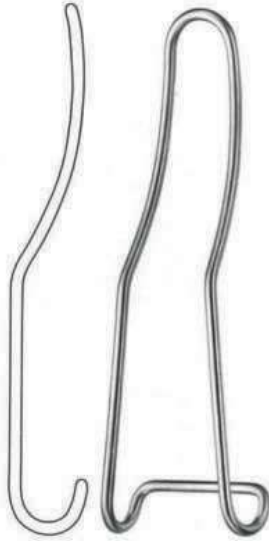

STERNBERG
IM-LCR-900.15
14.5 cm / 5 3/4"



UNIV. MINNESOTA
IM-LCR-901.34
15.5 cm / 6 1/8"

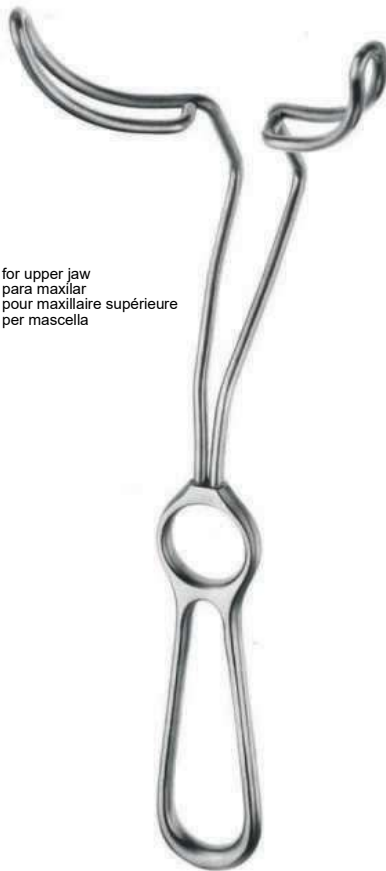

for upper jaw
para maxilar
pour maxillaire supérieure
per mascella

IM-LCR-902.21
21 cm / 8 1/4"



for lower jaw
para mandibula
pour maxillaire intérieure
per mandibola

IM-LCR-903.26
26 cm / 10 1/4"



Univer
univers
univers
univers

IM-LCR-904.27
15 cm / 6"

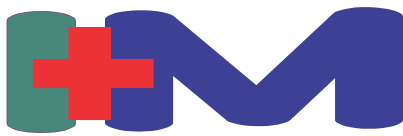

MOUTH GAGS



MOLT

IM-MG-400.10
10 cm / 4"
for children

IM-MG-401.15
15 cm / 6"
for adults



ROSER KONIG
IM-MG-402.45
16 cm / 6¼"



DENHART
IM-MG-403.60
13 cm / 5 1/8"

MOUTH GAGS



DINGMAN
IM-MG-404.00



IM-MG-405.11
55 x 25 mm
Fig.1

Tongue depressor
Bajalengua
Abaisse-langue
Abbassalingua

IM-MG-406.12
60 x 27 mm
Fig.2

IM-MG-407.13
70 x 30 mm
Fig.3

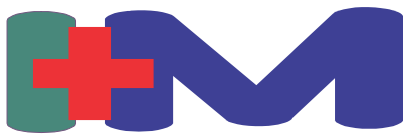

INSTRUMENT BOXES

Style A



	L	W	D
IM-IB-500-46	165 x	90 x	35 mm
IM-IB-500-50	200 x	100 x	35 mm
IM-IB-500-51	200 x	100 x	50 mm
IM-IB-500-53	230 x	130 x	50 mm
IM-IB-500-56	260 x	150 x	50 mm
IM-IB-500-58	280 x	140 x	60 mm
IM-IB-500-60	300 x	200 x	50 mm

Style B



	L	W	D
IM-IB-501-46	165 x	90 x	35 mm
IM-IB-501-48	180 x	80 x	50 mm
IM-IB-501-50	200 x	100 x	35 mm
IM-IB-501-51	200 x	100 x	50 mm
IM-IB-501-53	230 x	130 x	50 mm
IM-IB-501-55	250 x	120 x	60 mm
IM-IB-501-56	260 x	180 x	50 mm
IM-IB-501-58	280 x	140 x	60 mm
IM-IB-501-60	300 x	200 x	50 mm
IM-IB-501-62	320 x	150 x	60 mm
IM-IB-501-66	360 x	160 x	70 mm

L = Length W = Width D = Depth

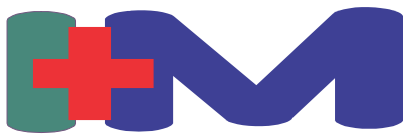

STERILIZATION INSTRUMENT



IM-SI-100.06
Ø = 6 cm (0.06l)



Kidney Trays

	L	W	D
IM-SI-400-17	170 x	100 x	35 mm
IM-SI-400-20	200 x	120 x	35 mm
IM-SI-400-25	250 x	140 x	40 mm
IM-SI-400-27	275 x	150 x	45 mm
IM-SI-400-30	305 x	140 x	50 mm



Mesh Trays Stainless Steel, 5X5mm Mesh

	L	W	D
IM-SI-800-01	250 x	250 x	50 mm
IM-SI-800-02	260 x	190 x	50 mm
IM-SI-800-03	380 x	250 x	50 mm
IM-SI-800-04	440 x	110 x	65 mm
IM-SI-800-05	480 x	250 x	50 mm
IM-SI-800-06	480 x	250 x	70 mm
IM-SI-800-07	500 x	150 x	100 mm

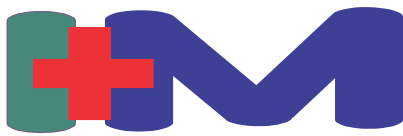

IBRAHIM MEDS

WE SERVE HUMANITY WITH EXCELLENCE

STERILIZATION INSTRUMENT

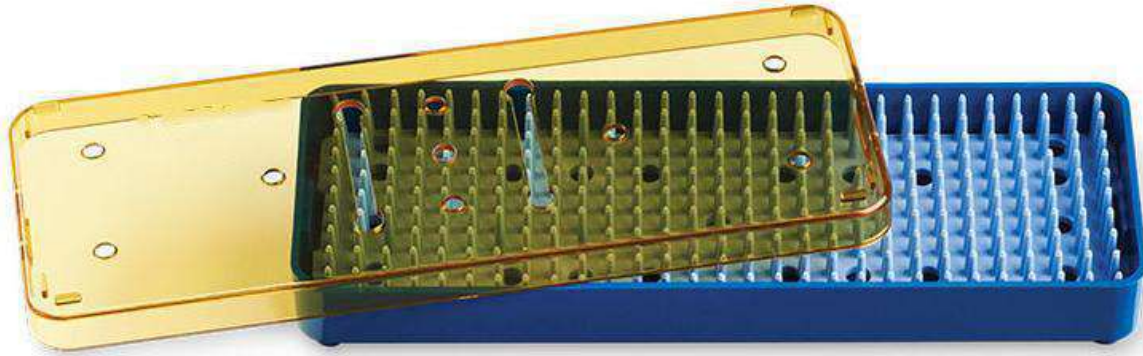

Sterilization Tray Fiber Material, With Silicon Mat

Item Code	Description
IM-SI-900.00	Size in inch: 7" x 2.5" x 0.75"

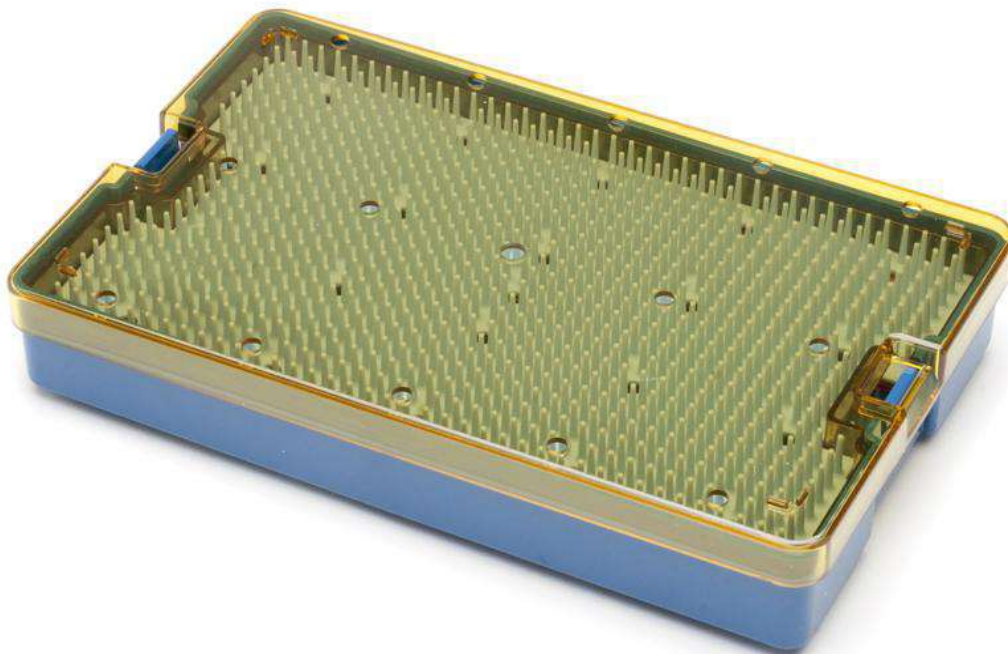

Sterilization Tray Fiber Material, With Silicon Mat

Item Code	Description
IM-SI-901.01	Size in inch: 10" x 6" x 0.75"
IM-SI-902.02	Size in inch: 10" x 6" x 1.5" With Double Silicon Mat

HAND RETRACTOR

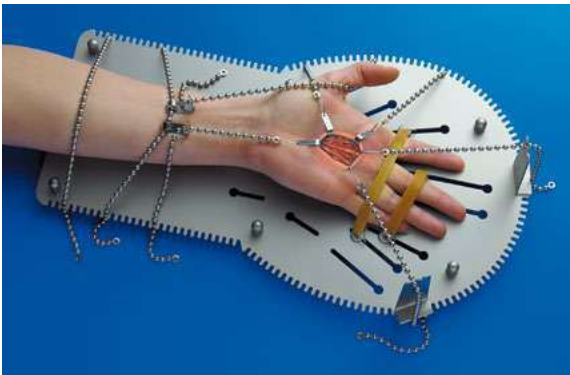
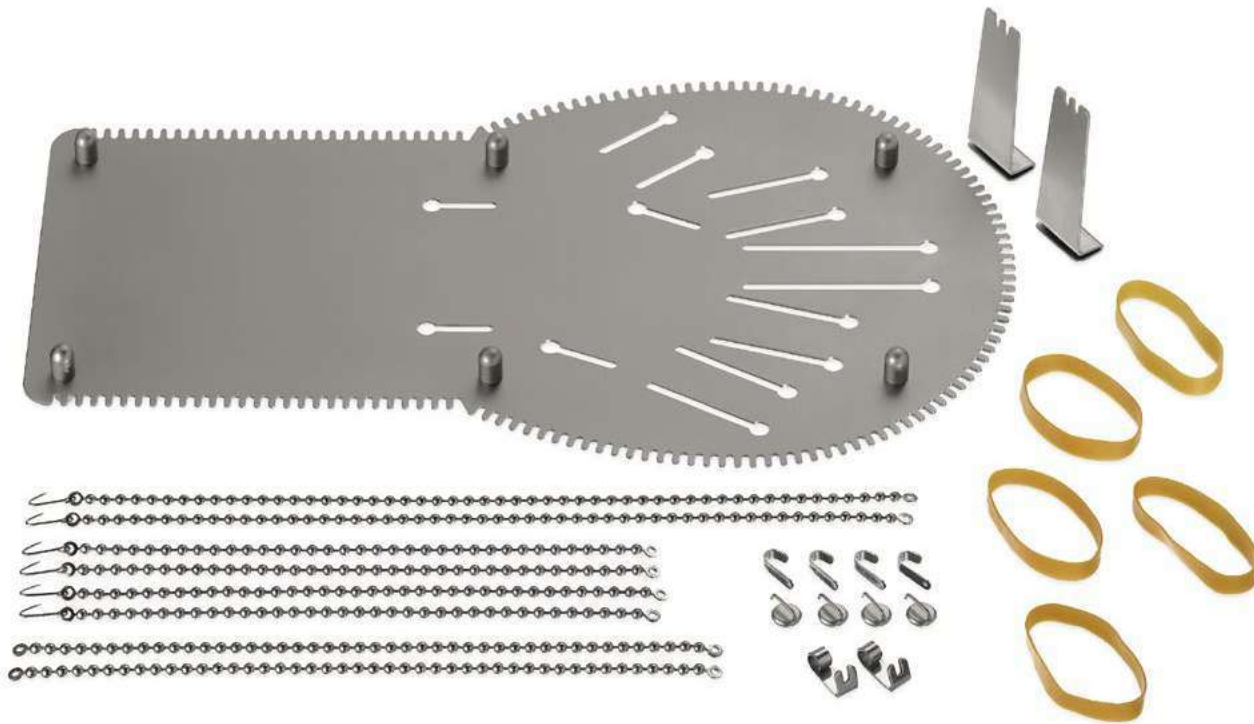

Tupperts Universal Hand Holder and Retractor Set enables the surgeon to fixate the hand in any position needed.

The patient's hand is held absolutely firm and allows unhindered work under the microscope.

Ball chains of varying length with skin or tendon hooks fixate the hand and lower arm on the Hand Holder.

Due to the slots around the Hand Holder, retraction in every direction is possible.

Upward retraction is easily achieved with the elevated chain holders.

The special container is designed for easy handling and safe storage.

Tupperts Hand Retarctor Set

IM-HR-1000.00



IBRAHIM MEDS

WE SERVE HUMANITY WITH EXCELLENCE

ABDOMINOPLASTY SET

IM-AS-101.00



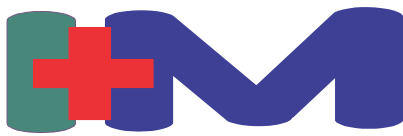

ABDOMINOPLASTY SET

IM-AS-101.00

Abdominoplasty Instruments Set Consisting of;

Scalpel blades #15

Scalpel blades #21

Scalpel handle, #7

Scalpel handle, #4l long

Ragnell kilner scissors, 13cm, curved – flattened at distal end

Adson delicate tissue and suture forceps, 15cm, 1×2 teeth

Adson brown delicate tissue forceps, 12cm, 9×9 teeth, straight – atraumatic

Potts smith tissue forceps, 20cm, 1×2 teeth – delicate

Allis Tissue Forcep 5X6 teeth, 16cm

Wright derf t.c. needle holder, 12.5cm, serrated

Mayo hegar t.c. needle holder, 15cm

Mayo hegar t.c. needle holder, 23cm

Backhaus towel clamp, 8.5cm

Joseph skin hook, double prong, sharp, 16cm, 10mm wide

Stevens Supercut Tenotomy Scissors, 10.5cm, Curved, Blunt – Delicate

Supercut mayo scissors, 14cm, straight

Supercut gorney scissors, 23cm, curved

Supercut gorney freeman scissors, 23cm, curved “gold tip”

Supercut scissors, 20cm, curved, slight bevel on shank, “gold tip”

Supercut scissors, 20cm, curved, strong bevel on shank

Farabeuf baby retractors, 12cm, double ended, set of 2

Israel retractor, 25cm, 6 blunt prongs, 60mm wide x 50mm deep

Saldanha solz abdominal retractor, 37cm

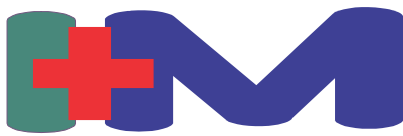

IBRAHIM MEDS

WE SERVE HUMANITY WITH EXCELLENCE

ABDOMINOPLASTY SET (Tummy Tuck)

IM-AS-102.00



ABDOMINOPLASTY SET (Tummy Tuck)

IM-AS-102.00

Abdominoplasty Set (Tummy Tuck), Consisting of;

Ruler Stainless
Knife Handle No #3
Halsted Mosquito Forceps Curved 12.5cm (4PC)
Mayo-Hegar Tc Needle Holder 16cm (2PC)
Webster Tc Needle Holder Plain Tip 12.5cm
Adson Tissue Forceps 1×2 teeth With Cross Serrated 12cm (2PC)
Joseph Hook Sharp Double Prong 10mm (2PC)
Mayo Scissors Straight 14cm Tc
Gorney Freeman Scissors TC Curved 23cm
Metzenbaum Scissors SuperCut Curved 15cm
Stevens Tenotomy Scissors Supercut Curved 11.5cm
Lahey Forceps 3×3 teeth 16cm (3PC)
Allis Tissue Forceps 5×6 teeth 16cm (2PC)
Adson Brown 9×9 Teeth 12cm
Us Army Retractor 2/set
Tissue Forceps 1×2 teeth 15cm
Iris Scissors Tc 10cm
Yancoskie Retractor 6 prongs
Freeman Retractor 4 prongs 22mm
Freeman Retractor 4 prongs 38mm
Meyerding Retractor Large 50mm x 90mm 23cm (2PC)
Lockwood Abdominal Demarcator 32cm

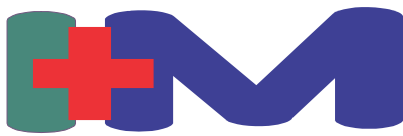

IBRAHIM MEDS

WE SERVE HUMANITY WITH EXCELLENCE

BLEHAROPLASTY SET A

IM-BSA-103.00



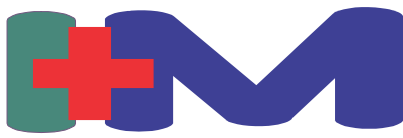

BLEPHAROPLASTY SET A

IM-BSA-103.00

BLEPHAROPLASTY SET A, Consisting of;

Gillies Delicate Retractor 19cm (2PC)
Joseph Skin Hook 16cm 2mm Double Prong Sharp (2PC)
Desmarres Lid retractor 9x12mm 13 cm
Scalpel handle No #3 12.5cm
Jaeger Lid Plate Stainless Steel
Mayo Scissors Straight T.C 14.5cm
Steven Delicate scissors curved sharp 11.5cm
Neivert Needle holders smooth 12.5cm
Halsted Mosquito Hemostatic forceps curved 12.5cm (4PC)
Backhaus Towel clamp 8.5cm (2PC)
Micro Adson Delicate forceps Tissue 1×2 teeth 12cm
Micro Adson Delicate forceps Tissue 1×2 teeth 15cm
Castroviejo Calipers Measuring Range 20mm 7cm
Castroviejo Needle Holder 14cm
Castroviejo Scissors 14cm
Putterman Eyelid Clamp
Gladstone Transmarginal Clamp
Berke Ptosis Froscep 12 cm

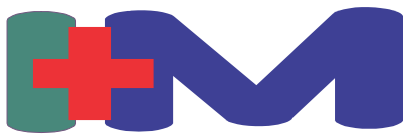

IBRAHIM MEDS

WE SERVE HUMANITY WITH EXCELLENCE

BLEHAROPLASTY SET B

IM-BSB-104.00



BLEPHAROPLASTY SET B

IM-BSB-104.00

BLEPHAROPLASTY SET B, Consisting of;

Scalpel Handle #3 Standard
Stevens Scissors 11.5cm Curved Sharp
Stevens Scissors 11.5cm Curved Blunt
Neivert Needle Holder 12.5cm
Halsted Mosquito Forceps 12.5cm Curved
Backhaus Towel Clamp 8.5cm
Gillies Dura And Skin Retractor Hook 19cm Small
Joseph Delicate Retractor 17cm 2 Prong 5mm Sharp
Joseph Delicate Tracheal Retractor 16cm 2 Prong 8mm Blunt
Supercut Mayo Scissors 14cm Straight
Desmarres Lid Retractor #1 14cm Small 9x12mm
Castroviejo Measuring guage 7 cm Measuring Guage 20mm
Bishop Harmon Iris Forceps 1X2 teeth 0.3mm
Castroviejo Suturing Forceps 1X2 teeth 0.9mm

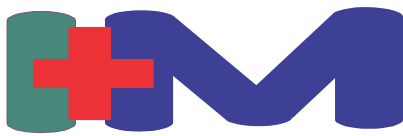

IBRAHIM MEDS

WE SERVE HUMANITY WITH EXCELLENCE

BREAST AUGMENTATION SET

IM-BAS-105.00



BREAST AUGMENTATION SET

IM-BAS-105.00

BREAST AUGMENTATION SET, Consisting of;

Scalpel Handle No. #3
Halsted Mosquito Forceps Curved 12.5cm (4PC)
Metzenbaum Scissors Supercut 18cm Curved (2PC)
Gorney Freeman Scissors Supercut curved 23cm
Mayo Scissors 18cm straight (2PC)
Iris Scissors TC straight 11.5cm (2PC)
Yankauer Suction Tube 28cm
Frazier Suction Tube 12 FR (2PC)
Adson Dressing Forceps 12cm (2PC)
Adson Tissue & Suture Forceps 1×2 teeth with tying platform (2PC)
Brown-Adson Forceps 9×9 teeth 12cm (2PC)
Tissue Forceps 1×2 teeth 15cm
Dressing Forceps serrated 15cm
Freeman Areola Marker 38mm
Freeman Areola Marker 42mm
Freeman Areola Marker 45mm
Freeman Areola Marker 50mm
McKissock Breast Marker 38mm Keyhole pattern
McKissock Breast Marker 42mm Keyhole pattern
McKissock Breast Marker 45mm Keyhole pattern
Mayo-Hegar Needle Holder TC 16cm
Webster Needle Holder TC smooth jaws 13cm
Halsey Needle Holder TC smooth jaws 14cm
McKissock Mammoplasty Caliper
Stainless Steel Ruler 15cm
Tebbetts Spatulated Breast Dissector 33cm
Silverstein Breast Dissector
Joseph Hook sharp 5mm 16cm (2PC)
Senn Muller Retractor Insulated sharp
US Army Retractor set of 2 Insulated
Freeman Retractor 4 prong 38mm (2PC)
Pediatric Ribbon Retractor malleable
Ferreira Fiber Optic Retractor 150x25mm Insulated
Deaver Fiber Optic Retractor
Tebbetts Fiber Optic Retractor 150x25mm Insulated

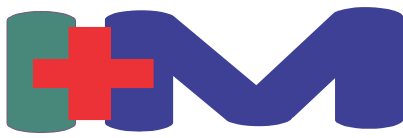

IBRAHIM MEDS

WE SERVE HUMANITY WITH EXCELLENCE

CHIN AUGMENTATION SET

IM-CAS-106.00



CHIN AUGMENTATION SET

IM-CAS-106.00

CHIN AUGMENTATION SET, Consisting of;

Scalpel Handle, #3 Standard

Iris Scissors, 9cm, Curved – Delicate

Baby Metzenbaum T.C. Scissors, 11.5cm, Curved

Metzenbaum T.C. Scissors, 14cm, Curved

Collier Needle Holder, 13cm

Neivert T.C. Needle Holder, 12.5cm, Smooth

Halsted Mosquito Forceps, 12.5cm, Curved

Joseph Skin Hook, Double Prong, Sharp, 16cm, 7mm Wide

Walter Bone Elevator, 14.5cm, 8mm, Curved

Walter Raspatory, 14.5cm, 8mm, Curved

Walter Alar And Nasal Retractor With Fiber Optic Illumination, 18.5cm

Aufricht Walter Nasal Retractor, 13.5cm, Double Ended, Sharp, 42x7mm

Aufricht Walter Nasal Retractor, 13.5cm, Double Ended, Blunt, 38x7mm

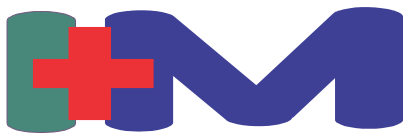

IBRAHIM MEDS

WE SERVE HUMANITY WITH EXCELLENCE

CLEFT & PALATE INSTRUMENTS SET

IM-CPIS-107.00

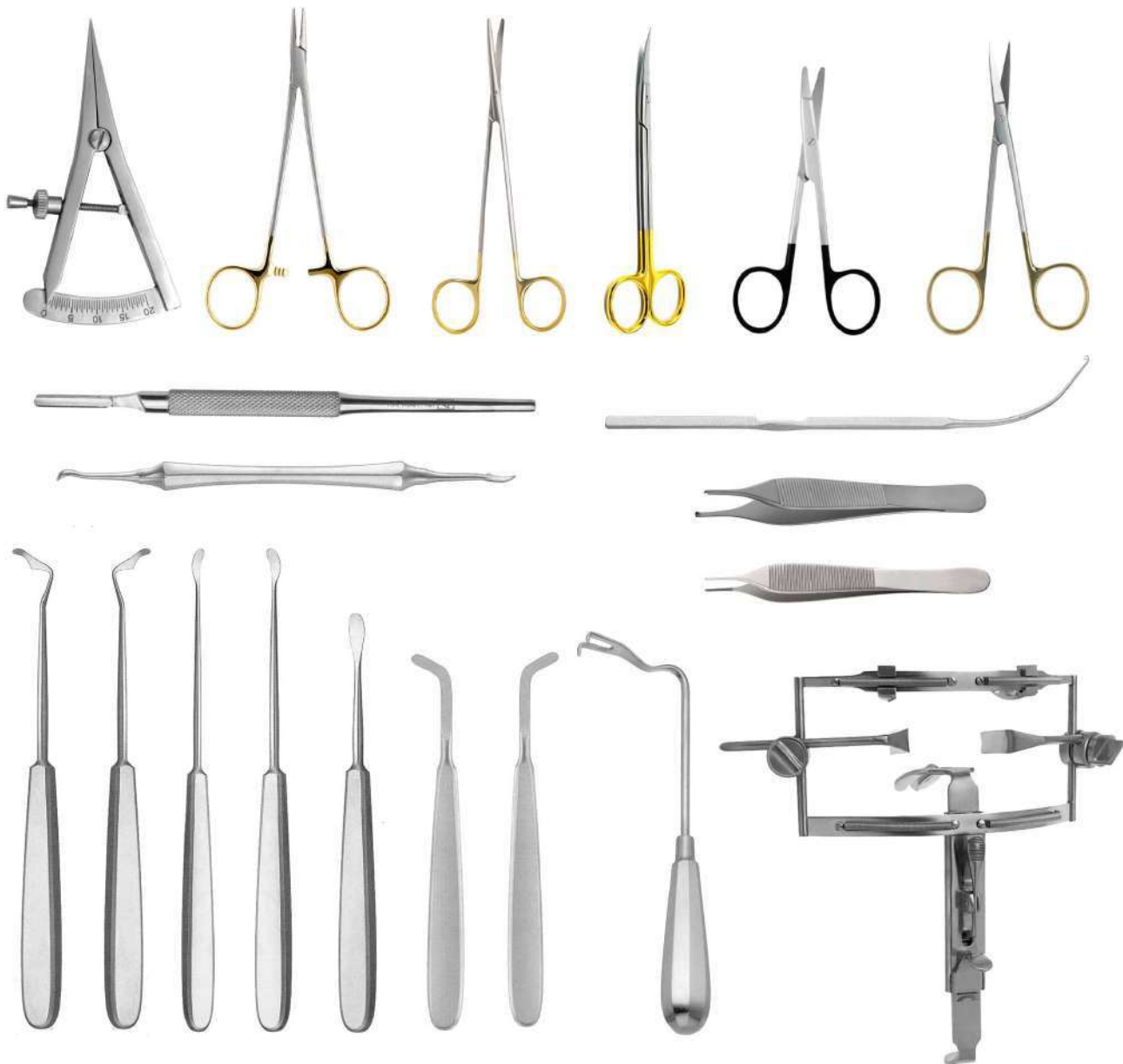

CLEFT & PALATE INSTRUMENTS SET

IM-CPIS-107.00

CLEFT & PALATE INSTRUMENTS SET, Consisting of;

Scalpel Round Handle 16cm
Adson Forceps 15cm Serrated
Adson Forceps 15cm 1×2 Teeth
Iris Supercut Scissors 11.5cm Straight
Iris Supercut Scissors 11.5cm Curved
Ragnell Kilner Scissors 13cm Curved
Supercut Plus Kelly T.C. Scissors 16cm Curved
Metzenbaum T.C. Scissors 18cm Curved
Crile Wood T.C. Needle Holder 15cm
Blocksma Cleft Palate Hook 18cm 3mm 2 Prong
Cleft Palate Raspatory 14cm #1 Left
Cleft Palate Raspatory 14cm #2 Right
Kahre Cleft Palate Raspatory 17cm
Mcindoe Cleft Palate Raspatory 16.5cm
Muco-Periosteal Retractor 19cm
Wang Cleft Palate Elevator 15.5cm
Wang Cleft Palate Elevator 18cm Right
Wang Cleft Palate Elevator 18cm Left
Wang Cleft Palate Elevator 18cm Right Angled
Wang Cleft Palate Elevator 18cm Left Angled
Castroviejo Caliper 7cm 20mm Measuring Range
Dingman Mouth Gag Complete

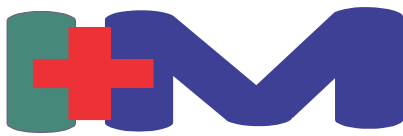

IBRAHIM MEDS

WE SERVE HUMANITY WITH EXCELLENCE

FACE & FORHEAD LIFT SET

IM-FFLS-108.00



FACE & FOREHEAD LIFT SET

IM-FFLS-108.00

FACE & FOREHEAD LIFT SET, Consisting of;

Scalpel Blades #15 – Sterile, 100/Box

Scalpel Handle, #7

Micro Adson Forceps 12cm 1×2 Teeth – 0.8mm Tips

Adson Brown Delicate Tissue Forceps 12cm 7×7 Teeth Straight – Atraumatic

Select Tissue Forceps 20cm 1×2 Teeth – Extremely Fine

Nagata T.C. Needle Holder 12.5cm Extra Fine

Baby Crile Wood T.C. Needle Holder 15cm

Backhaus Towel Clamp 8.5cm

Gillies Dura And Skin Retractor Hook 19cm Small

Joseph Delicate Retractor 17cm 2 Prong 5mm Sharp

Iris Supercut Scissors 12.5cm Curved

Supercut Mayo Scissors 14cm Straight

Gold Tip Supercut Scissors 20cm Curved Slight Bevel On Shank

Gold Tip Supercut Scissors 20cm Curved Strong Bevel On Shank

Farabeuf Baby Retractors 12cm Double Ended Set Of 2

Walter Retractor 19cm 4 Prongs 38mm

Langenbeck Kocher Retractor #13 15mm Wide X 80mm Deep 21cm

Solz Racket Retractor 12.5cm 45x100mm

Pitanguy Facelift Marker 16cm 5mm Wide

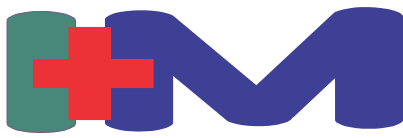

IBRAHIM MEDS

WE SERVE HUMANITY WITH EXCELLENCE

FACELIFT SET

IM-FLS-109.00



FACELIFT SET

IM-FLS-109.00

FACELIFT SET, Consisting of;

Adson Dressing Forcep TC 12cm (2PC)
Allis Forceps 15cm 5×6 teeth (4PC)
Facelift SuperCut Scissors 16.5cm Curved (2PC)
Face Lift SuperCut Scissors 20.5cm Curved (2PC)
Backhaus Towel Forceps 9cm (4PC)
Adson Brown 7×7 Forcep Tc 12cm
Adson Brown 7×7 Forcep TC 15cm (2PC)
Crile Forceps Curved 16cm (3PC)
Crow Coagulation Insulated Forcep TC 23cm (3PC)
Gillies Skin Hook 18cm (3PC)
Halstead Mosquito Forceps Curved 12.5cm (8PC)
Halstead Mosquito Forceps Curved 12.5cm 1×2 teeth (4PC)
Adson Horton 12cm TC 1×2 teeth (2PC)
Adson Horton 15cm Tc 1×2 teeth
Knife Handle #3 (2PC)
Knife Handle #4 (2PC)
Light Weight Straight Skin Hook 15cm Delicate (3PC)
Mayo SuperCut Scissors 17 cm Curved
Metzenbaum Delicate SuperCut Scissors 18 cm Curved
Nasal Tip Retractor 11cm 8mm
PAR Needle Holder 11.5cm TC (4PC)
Pitanguy Flap Grasping Forceps 14cm
Ribbon Iris Scissors 9cm Curved
Ruler 15cm

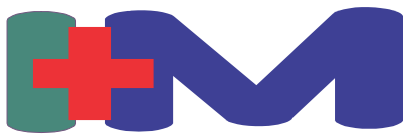

IBRAHIM MEDS

WE SERVE HUMANITY WITH EXCELLENCE

MAMMAPLASTY SET

IM-MPS-110.00



MAMMAPLASTY SET

IM-MPS-110.00

Mammaplasty Set, Consisting of;

Scalpel Blades #15 – Sterile 100/Box
Scalpel Handle #7
Jabeley Scissors 13cm Curved Sharp/Sharp
Metzenbaum Scissors 20cm Curved Standar Pattern
Micro Adson Forceps 12cm 1×2 Teeth 0.8mm Tips
Gruenwald Nasal Bayonet Forceps 19.5cm Serrated Tips
Baby Crile Wood Needle Holder 15cm
Baby Crile Wood T.C. Needle Holder 15cm
Jabeley Supercut Scissors 13cm Curved Sharp/Sharp
Solz Gold Tip TC with Supercut Scissors 20cm Curved Slight Bevel On Shank
Solz Gold Tip TC with Supercut Scissors 20cm Curved Strong Bevel On Shank
Farabeuf Baby Retractors 12cm Double Ended Set Of 2
Langenbeck Kocher Retractor #13 15mm Wide X 80mm Deep 21cm
Atraumatic Breast Dissector 34cm
Breast Hook Dissector Curved to Left 36cm
Breast Hook Dissector Curved to Right 36cm
Areola Marker Blunt 36mm Diameter
Areola Marker Blunt 40mm Diameter
Areola Marker Blunt 42mm Diameter
Areola Marker Blunt 45mm Diameter
Marx Breast Retractor 27cm 125 X 30mm
Round Bowl For Solutions/Marking Color 60x30mm 60cc

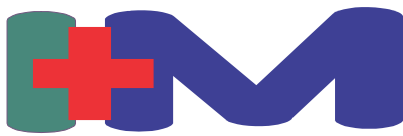

IBRAHIM MEDS

WE SERVE HUMANITY WITH EXCELLENCE

PLASTIC SURGERY INSTRUMENTS SET

IM-PSIS-111.00

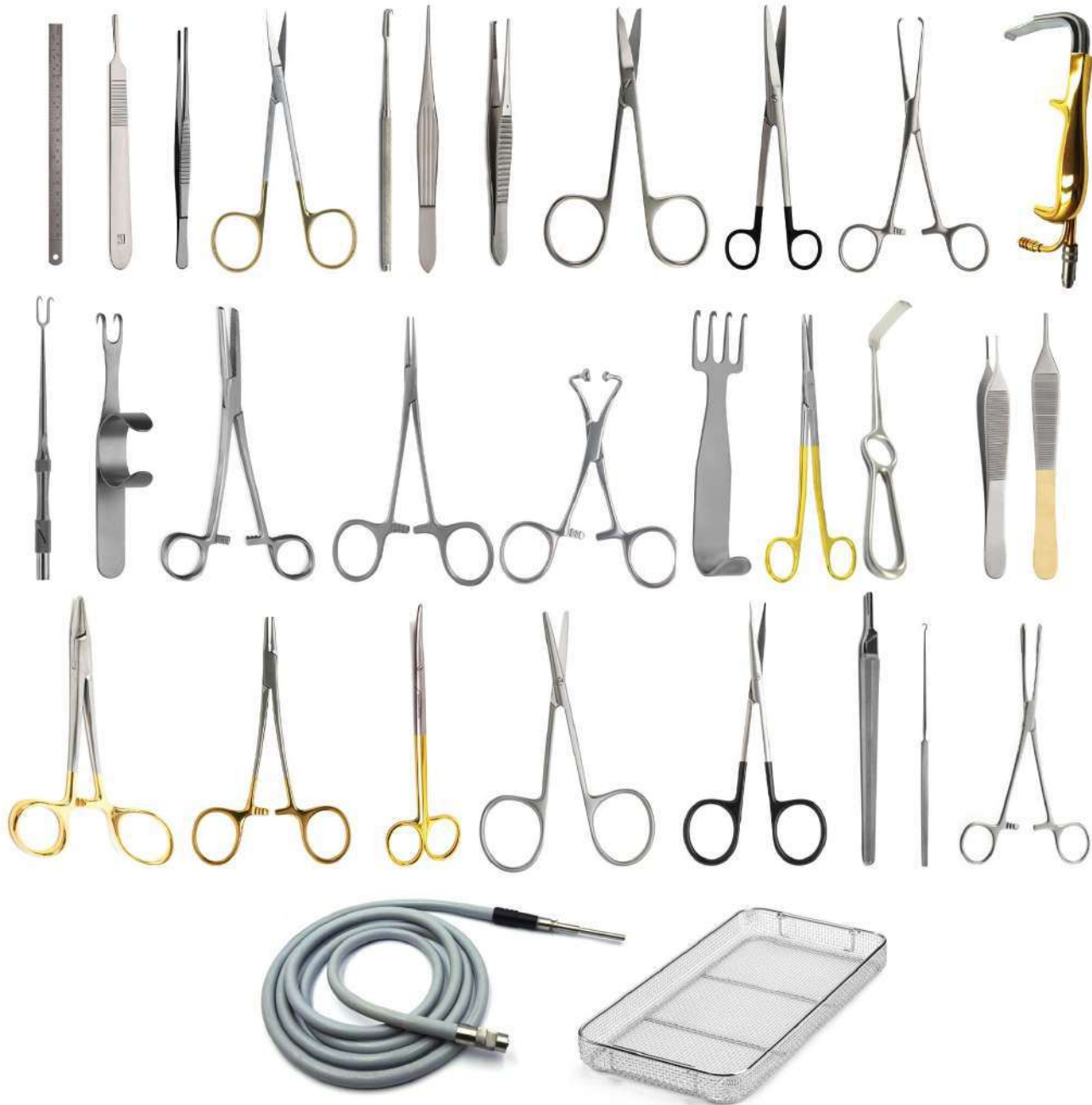

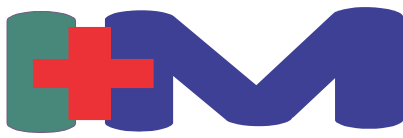

IBRAHIM MEDS

WE SERVE HUMANITY WITH EXCELLENCE

PLASTIC SURGERY INSTRUMENTS SET

PSS-111.00

PLASTIC SURGERY INSTRUMENTS SET, Consisting of;

Rampley Sponge Holder 9”(2PC)
Barron Scalpel Handle(2PC)
Steven Tenotomy Scissor 4.5” Supercut Curved
Strabismus Scissor 4.5”
Metzenbaum Scissor 8” Curved
Adson Dressing Forcep 12cm TC
Adson Tissue Forcep 1 x 2 teeth 12cm
Nagata Needle Holder 12.5cm TC (2PC)
Neivert Needle Holder 12.5cm
Gillies Skin Hook 6” (2PC)
Langenbeck Retractor 21cm 8x25mm (2PC)
Langenbeck Retractor 21cm 12x45mm (2PC)
Joseph Skin Hook 2mm 2 Prongs (2PC)
Joseph Skin Hook 2mm 5 Prongs (2PC)
Joseph Skin Hook 7mm 2 Prongs
Tebbetts Self Retaining Skin Hook 6” (4PC)
Nasal Tip Retractor 11cm (4PC)
Tebbetts Retractor 90x27cm with Fiber Optic Light Guide
Gorney Freemann Supercut Scissor Curved 23cm
Maxwell Flap Retractor 10cm 22mm wide
Mesh Wire Basket 480x250x70mm
Ball & Socket Towel 12cm (2PC)
Halsted Mosquito Curved 12.5cm (3PC)
Halsted Mosquito Straight 12.5cm (2PC)

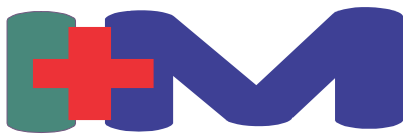

IBRAHIM MEDS

WE SERVE HUMANITY WITH EXCELLENCE

MICRO SURGERY INSTRUMENTS SET

IM-MSIS-112.00

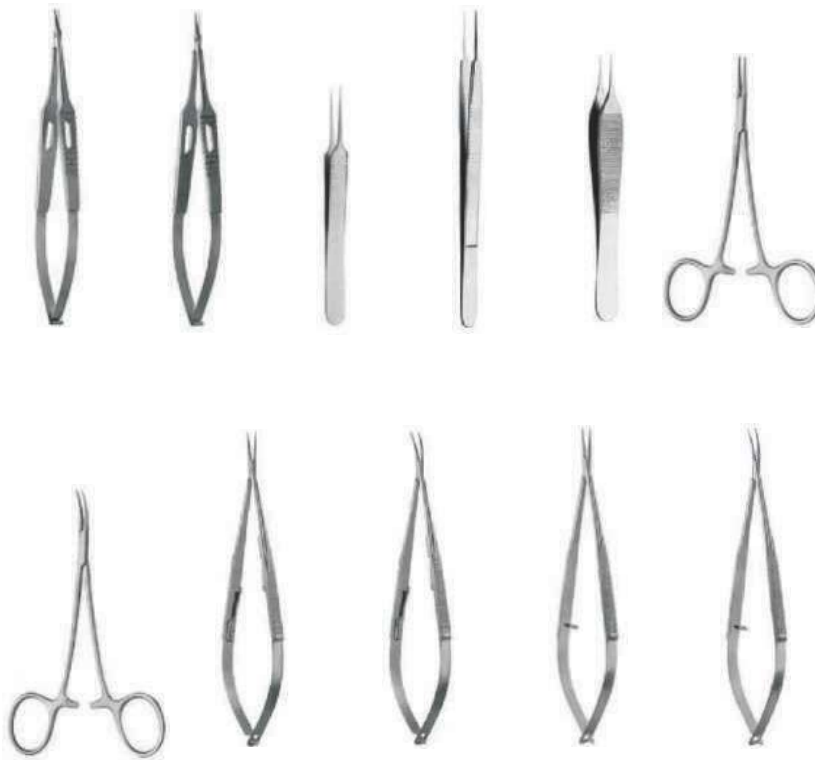

KOSHIMA Micro instruments set - complete Consisting of :

- KOSHIMA Micro scissors . curved . vanna-type cutting edges (15cm)
- KOSHIMA Micro scissors . straight . vanna-type cutting edges (15cm)
- KOSHIMA Micro forceps (11 cm)
- MICRO 2000 (KOSHIMAZ) micro forceps (14cm)
- JACOBSON ADSON (KOSHIMA) Micro needle holder, straight .
with catch (14.5 cm)
- MICRO JACOBSON (KOSHIMA) Hemostatic forceps,
straight (12.5cm)
- MICRO JACOBSON (KOSHIMA) Hemostatic forceps,
curved (12.5cm).
- CASTROVIEJO (KOSHIMA) Micro needle holder, curved .
with catch (14.5 cm)
- CASTROVIEJO (KOSHIMA) Micro needle holder, curved,
with catch (14.5cm)
- CASTROVIEJO (KOSHIMA) Micro needle holder, straight, (14.5cm)
- CASTROVIEJO (KOSHIMA) Micro needle holder, curved, (14.5cm)

RHINOPLASTY INSTRUMENTS (WALTER SET)

IM-RIS-113.00

RhinoPlasty Instruments Set (Walter Set), Consisting of;

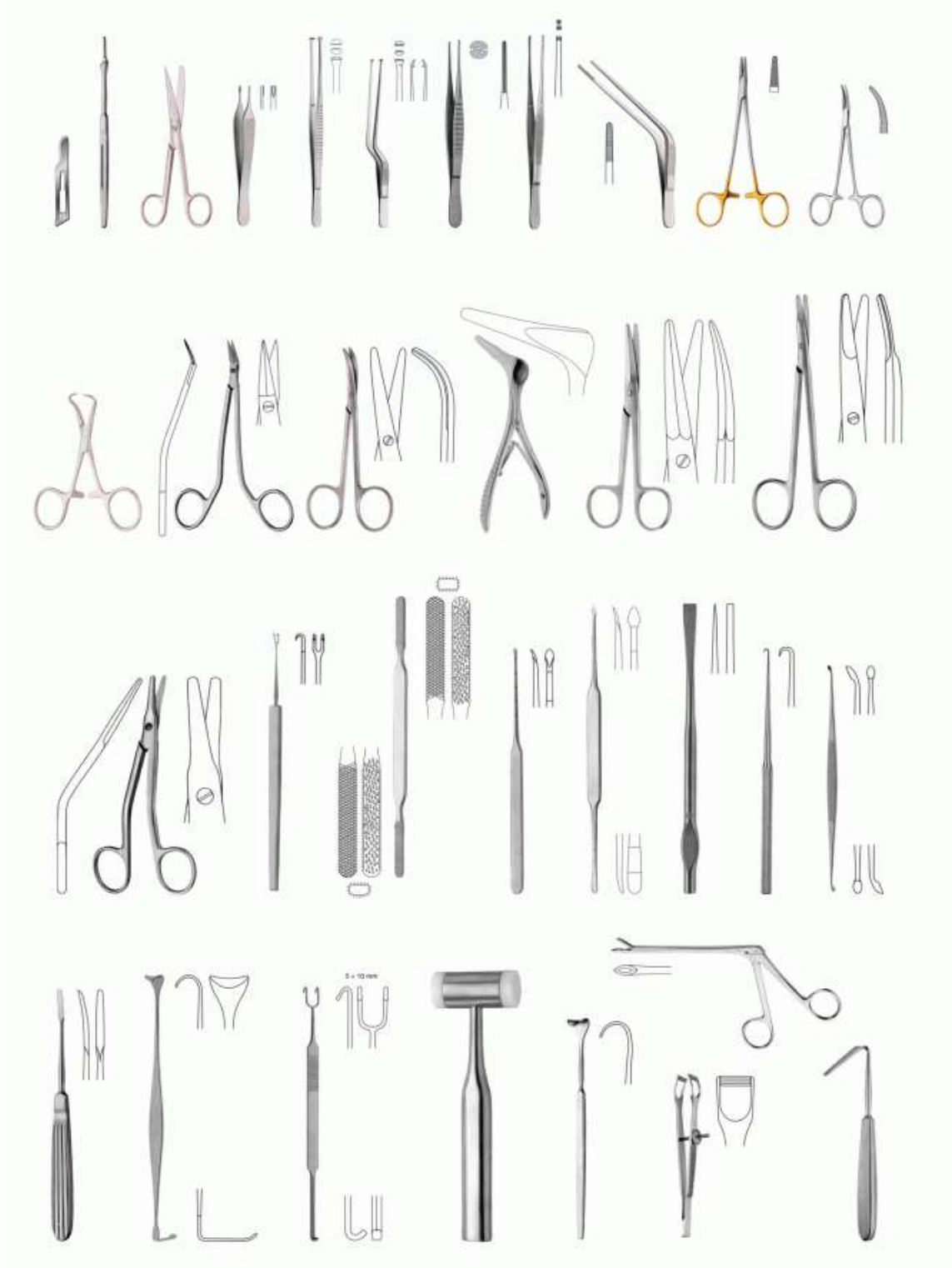

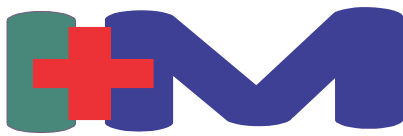

RHINOPLASTY INSTRUMENTS (WALTER SET)

IM-RIS-113.00

RhinoPlasty Instruments Set (Walter Set), Consisting of;

Scalpel Handle, #7k,
Surgical Operating Scissors, 14.5cm, Curved - Sharp/Blunt
Ragnell Kilner Scissors, 15cm, Curved - Flattened At Distal End
Fox T.C. Gum And Tissue Scissors, 13cm, Curved, 1 Serrated Blade
Adson Brown Delicate Tissue Forceps, 12cm, 7x7 Teeth, Straight
Adson Brown Delicate Tissue Forceps, 12cm, 9x9 Teeth, Straight
Semken Delicate Tissue Forceps, 12.5cm, 2x3 Teeth, Straight
Debakey At Vascular Forceps, 15cm - 1.5mm Tips
Bayonet Grasping Forceps, 16cm
Bayonet Grasping Forceps, 16cm, 1x1 Teeth
Troeltsch Wilde Angular Forceps, 13cm, Adult Size - Serrated
Grooved Director And Tongue Tie, 11.5cm
Frazier Fergusson Suction Tube, 18cm, Angled, 10 French e
Senning T.C. Needle Holder, 17cm, Serrated
Halsted Micro Mosquito Forceps, 12.5cm, Curved
Backhaus Towel Clamp, 8.5cm
Gross Dressing Forceps, 20cm, Straight - Without Catch, Box Lock
Walter Cope Retractor, 17.5cm
Joseph Skin Hook, 16cm, Single Prong, Sharp
Guthrie Double Retractor Hook, 13cm, 2mm Wide, Sharp
Lempert Raspatory, 17cm, 4mm, Delicate, Sharp
Supercut Walter Dorsal Scissors, 14cm, Angular
Supercut Walter Cottle Dorsal Scissors, 16cm, Curved
Medicon Mallet, 18.5cm, Plastic Facings, 200 Grams, 25mm Diameter
Walter Williger Bone Curette, 13.5cm, 2/2mm, Double Ended, Sharp, Angled
Defourmentel Bone Rongeur, 19cm, Straight, Slender Beaks - Jaws 3mm Wide
Weil Blakesley Wilde Ethmoid Bone Forceps #3, 120mm Shaft, 4.2mm
Weil Blakesley Wilde Ethmoid Bone Forceps #2, 45 Degree Angle, 120mm Shaft, 3.6mm
Myles Nasal Through Cutting Forceps #4, 120mm Shaft
Cottle Nasal Septum Speculum, 14cm, 50mm
Cottle Elevator, 16cm, 2.5mm
Masing Septum Elevator, 22cm, 5/5mm, Double Ended
Aufrecht Walter Nasal Retractor, 13.5cm, Double Ended, Sharp, 42x7mm
Aufrecht Walter Nasal Retractor, 13.5cm, Double Ended, Blunt, 38x7mm
Walter Chisel/Osteotome, 19cm, 3mm, Modified
Walter Chisel/Osteotome, 19cm, 5mm, Modified
Walter Osteotome, 19cm, 2mm, Straight
Walter Osteotome, 19cm, 12mm, Straight
Walter Chisel/Osteotome, 19cm, 12mm, Modified
Walter Osteotome, 19cm, 6mm, Curved
Walter Cantanares Lifting Scissors, 16cm, Curved
Fomon Rhinoplasty Scissors, 12.5cm
Cottle Columella Forceps, 11cm
Fomon Bone And Nasal Rasp, 20cm
Asch Septum Straightening Forceps, 22cm, Angled
Brunings Tongue Depressor, 19cm, 14mm

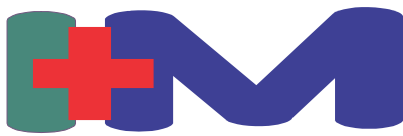

IBRAHIM MEDS

WE SERVE HUMANITY WITH EXCELLENCE

RHINOPLASTY INSTRUMENTS (GUBISCH SET)

IM-RIS-114.00

RHINOPLASTY INSTRUMENTS SET (Gubisch Set), Consisting of;

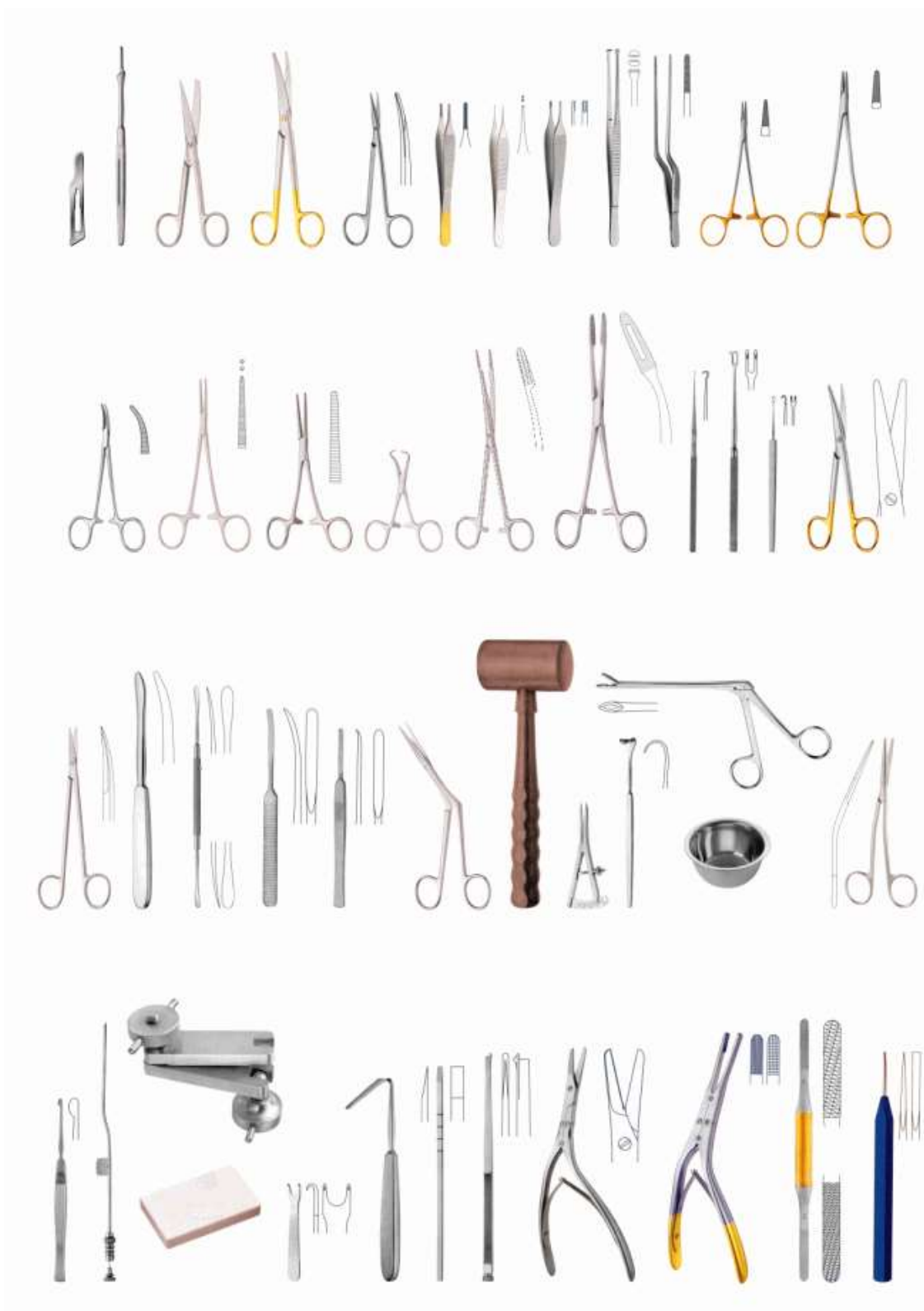

IM-RIS-114.00**RHINOPLASTY INSTRUMENTS (GUBISCH SET)****RHINOPLASTY INSTRUMENTS SET (Gubisch Set), Consisting of;**

Scalpel Blades #15 - Sterile,
Scalpel Handle, #7
Surgical Operating Scissors, 13cm, Straight - Sharp/Blunt
Mayo Stille T.C. Operating Scissors, 17cm, Curved
Reynolds Jameson Scissors, 14cm, Curved - With Fine, Rounded Points
Adson T.C. Tissue Forceps, 12cm
Micro Adson Forceps, 12cm, 1x2 Teeth - 0.8mm Tips
Adson Brown Delicate Tissue Forceps, 12cm, 7x7 Teeth, Straight - Atraumatic
Dressing Forceps, 20cm - Modified Swedish Pattern
Nelson Tissue Forceps, 15cm
Gruenwald Jansen Nasal Dressing Bayonet Forceps, 16cm, Serrated
Gubisch T.C. Needle Holder, 12.5cm, Extra Fine
Crile Wood T.C. Needle Holder, 15cm
Halsted Micro Mosquito Forceps, 12.5cm, Curved
Leriche Artery Forceps, 15cm, 1x2 Teeth, Straight
Pean Hemostatic Forceps, 14cm, Straight
Backhaus Towel Clamp, 13cm
Dressing Forceps, 17.5cm, Curved, Delicate
Gross Dressing Forceps, 20cm, Curved - With Catch, Box Lock
Barsky Skin Hook, 15cm, Single Prong, Sharp
Joseph Delicate Retractor, 17cm, 2 Prong, 5mm, Sharp
Guthrie Double Retractor Hook, 13cm, Sharp
Supercut Plus T.C. Mayo Scissors, 14cm, Straight
Supercut Plus T.C. Mayo Scissors, 17cm, Curved
Supercut Plus Metzenbaum T.C. Scissors, 18cm, Curved
Supercut Plus Kelly T.C. Scissors, 16cm, Curved
Langenbeck Bone Elevator, 20cm, 7mm, Blunt
Freer Raspatory, 19cm, 5/5mm, Double Ended, Sharp / Sharp
Williger Raspatory, 16cm, 5mm, Sharp
Mckenty Raspatory, 15cm, 4mm, Sharp, Light Curve
Supercut Heymann Nasal Scissors, 18cm
Supercut Plus Fomon T.C. Dorsal Scissors, 13cm, Angular
Mallet, 26cm, Novotex Plastic, 240 Grams, 45mm Diameter
Round Bowl For Solutions, 40x20mm, 20cc
Round Bowl For Solutions/Marking Color, 60x30mm, 60cc
Round Bowl For Solutions, 80x40mm, 160cc
Round Bowl For Solutions, 110x55mm, 400cc
Castroviejo Caliper, 7cm, 20mm Measuring Range
Desmarres Lid Retractor #2, 14cm, Medium, 10x14mm
Killian Asept Nasal Speculum, #4, 90mm (Modified)
Weil Blakesley Wilde Ethmoid Bone Forceps #3, 120mm Shaft, 4.2mm
Freer Septum Knife (Mucosa Scalpel), 16cm
Cottle Nasal Speculum, Delicate, 15cm, 55mm
Gubisch Suction Raspatory With Guide And Bypass Hole, 20cm, 4mm
Gubisch Suction Raspatory With Guide, 17cm, 4mm
Cartilage Cutting Block, Teflon, 85x55x10mm
Gubisch Cartilage Crusher, 65x30mm
Gubisch Kilner Double Nasal Hook (Alar Retractor), 8cm, Sharp, 5x10mm
Gubisch Aufrecht Nasal Retractor, 17cm, 50x6-12mm
Cottle Gubisch Chisel, 18cm, 5mm, Graduated, Hollow Cut
Cottle Gubisch Chisel, 18cm, 12mm, Graduated, Hollow Cut
Gubisch Osteotome, 18.5cm, 3mm, Aluminium Handle
Fanous Osteotome, 19.5cm, 4mm, Straight, With Guide Thorn - 1)
Caplan Nasal Septum Scissors, 20cm, Serrated
Gubisch Fomon T.C. Nasal Rasp, 20cm
Rubin T.C. Septal Morselizer Forceps, 20cm, With Protective Guard
Buchwald Tongue Spatula, 18cm, 18x23mm

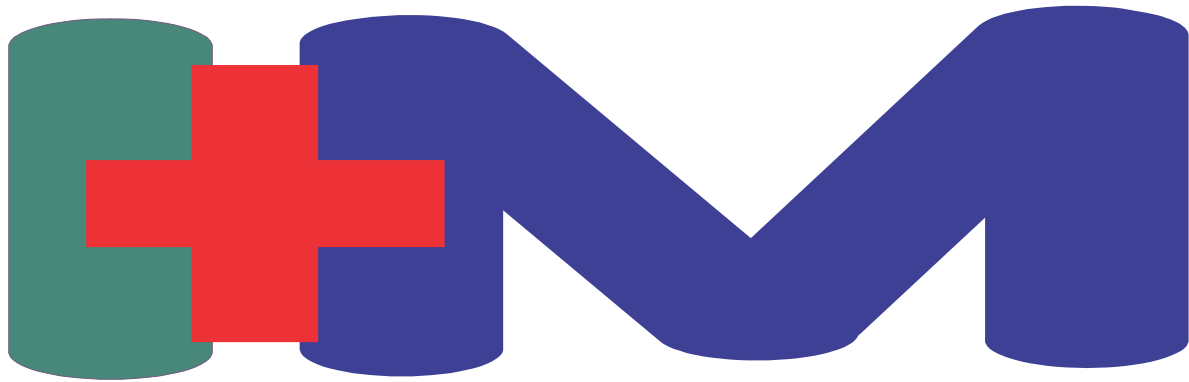

IBRAHIM MEDS

I N S T R U M E N T S

 77 A Model Town Ugoki Sialkot

 +92 52 3571235

 +92 52 4007564

 +92 300 7163508 , +92 307 6427547

 info@ibrahimmeds.com

 amjad@ibrahimmeds.com

 www.ibrahimmeds.com