

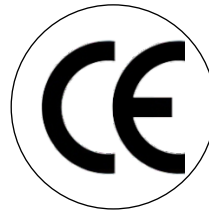

WE SERVE HUMANITY WITH EXCELLENCE

IBRAHIM MEDS



22- ORAL MAXILLO FACIAL SURGERY

Oral Maxillo Facial Surge

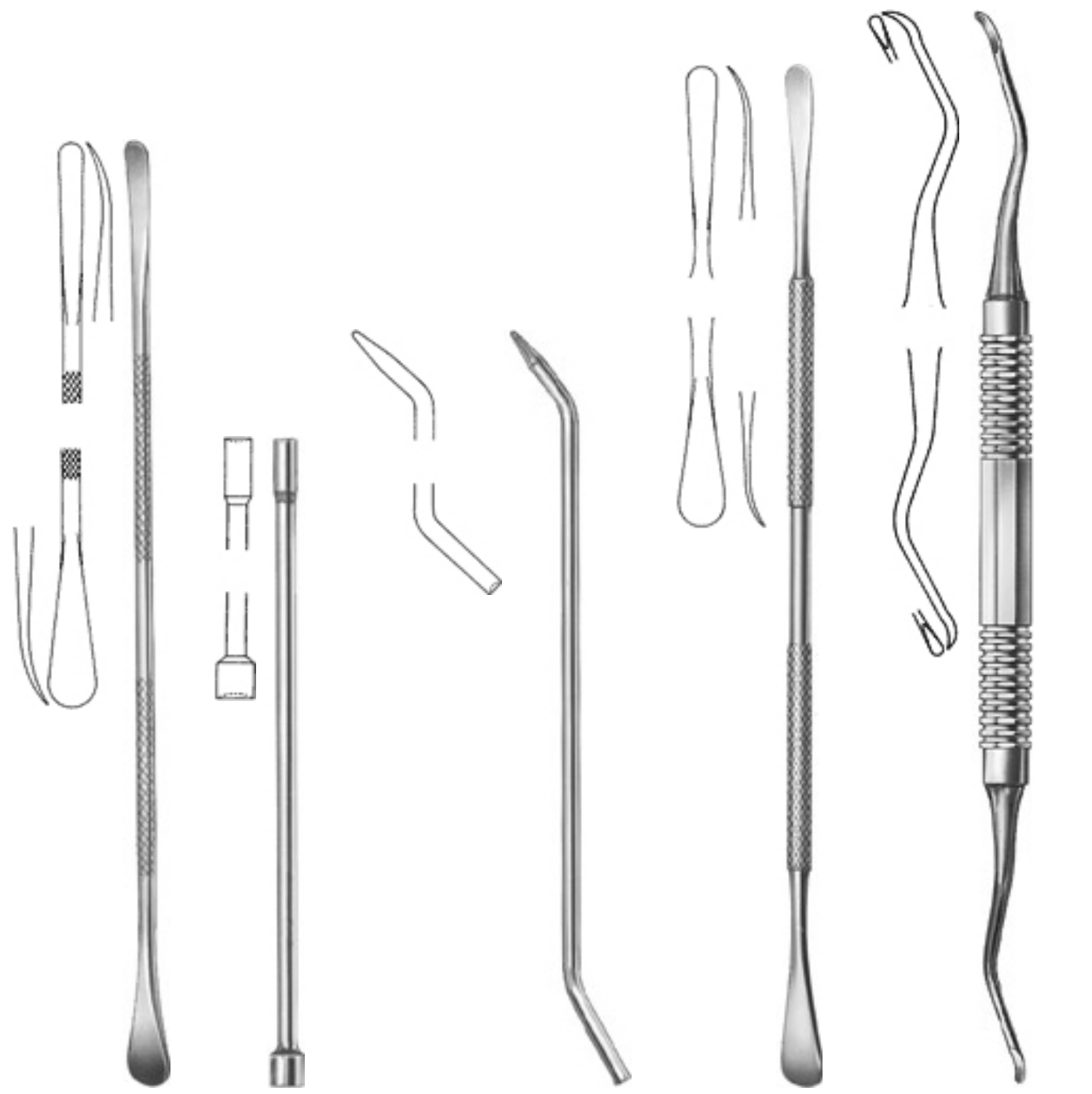

IM-22-011-17
Terry
17cm 6 3/4"
Elevator
5,0 / 8,0 mm
for elevation of
alveolar flaps

IM-22-012-11
Terry
11cm 4 1/4"
Graft Packer
Graft Packer

IM-22-013-13
13cm 5"
Graft Packer
Graft Packer

IM-22-014-18
Terry
18cm 7"
Periosteal
Elevator
3,0 / 7,0 mm
for subperio
steal tunnels

IM-22-015-18
18cm 7"
Sinus Lift Curette
2,6 / 2,6 mm

Oral Maxillo Facial Surge



IM-22-015-02
17.5cm 7"
Sinus Lift Curette
2,6 / 2,6 mm

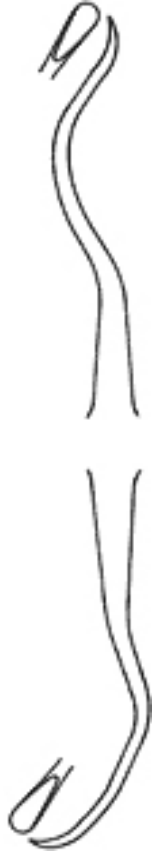

IM-22-015-03
18cm 7"
Sinus Lift Curette
4,1 / 4,1 mm

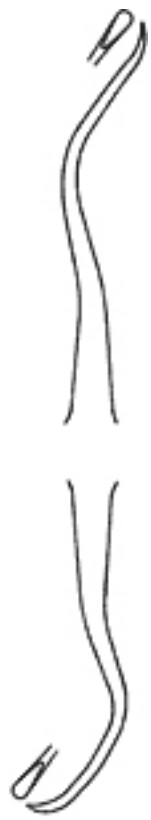

IM-22-015-04
18.5cm 7 1/4"
Sinus Lift Curette
4,1 / 4,1 mm



IM-22-015-05
18.5cm 7 1/4"
Sinus Lift Curette
6,7 / 6,7 mm



Oral Maxillo Facial Surge

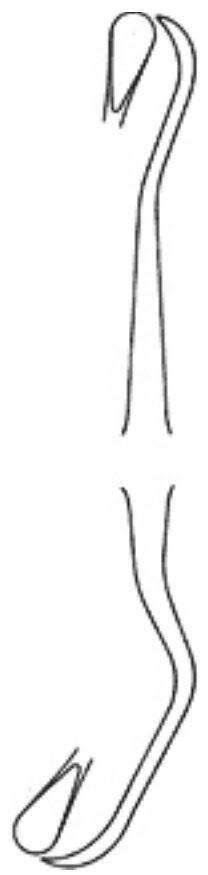

IM-22-015-07
19cm 7 1/2"
Sinus Lift Curette
6,7 / 6,7 mm

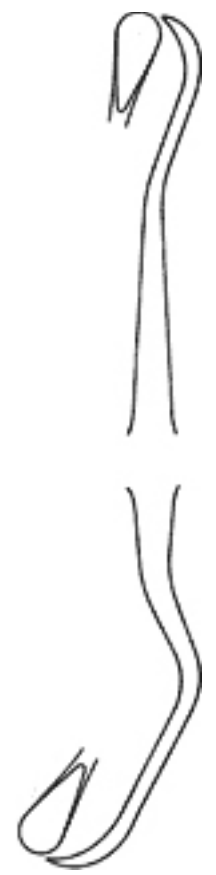

IM-22-015-08
16cm 6 1/4"
Sinus Lift Curette
2,8 / 6,2 mm



IM-22-015-09
16cm 6 1/4"
Sinus Lift Curette
2,8 / 6,2 mm



Oral Maxillo Facial Surge



IM-22-015-10
15cm 6"
Sinus Lift Curette
3,1 / 3,1 mm

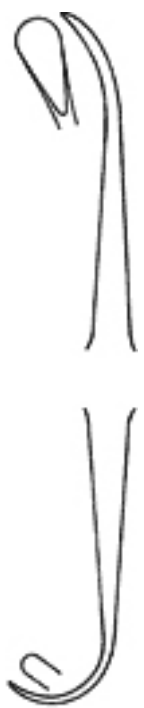

IM-22-015-11
17cm 6 3/4"
Sinus Lift Curette
5,6 / 5,6 mm



IM-22-016-01
16.5cm 6 1/2"
Sinus Lift Curette
Fig. 1



IM-22-016-02
16.5cm 6 1/2"
Sinus Lift Curette
Fig. 2



Oral Maxillo Facial Surge

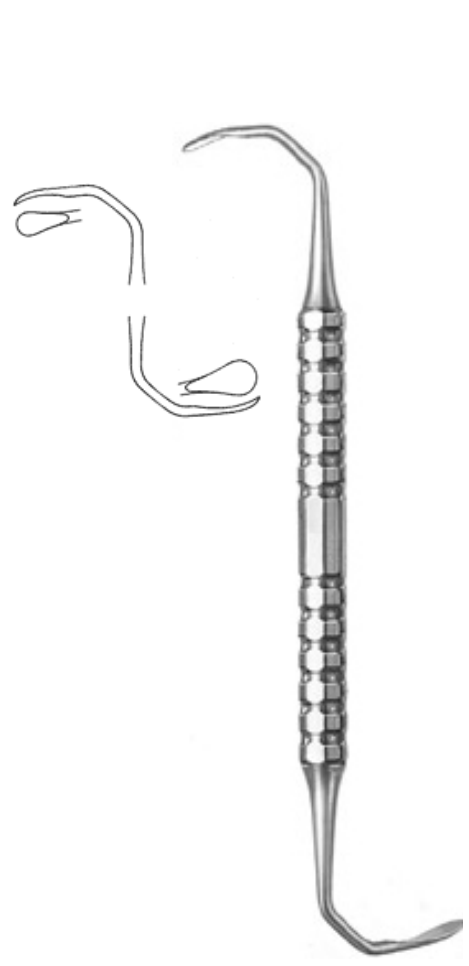

IM-22-016-03
14cm 5 1/2"
Sinus Lift Curette
Fig. 3

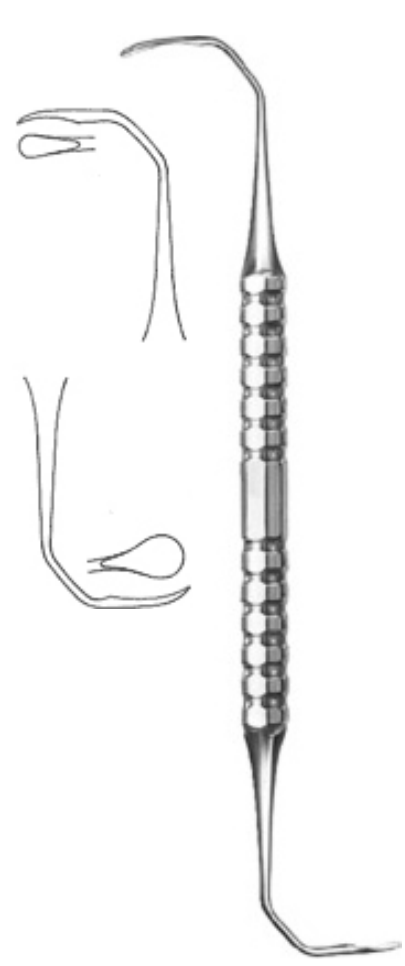

IM-22-016-04
15cm 6"
Sinus Lift Curette
Fig. 4

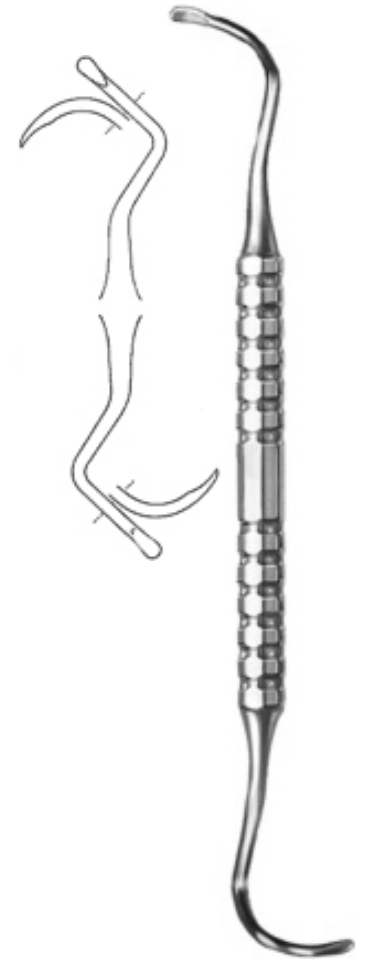

IM-22-016-05
15cm 6"
Sinus Lift Curette
Fig. 5

Oral Maxillo Facial Surge



IM-22-017-01
Lindemann
4.5cm 1 3/4"
Burrworking length
10 mm
for vertical cuts
in the buccal
aspect of the mandible



IM-22-017-02
Lindemann
6.5cm 2 1/2"
Burrworking length
22 mm
for vertical cuts in
the buccal aspect of the
mandible



IM-22-017-03
Lindemann
8cm 3 1/4"
Burrworking length
35 mm
for vertical cuts in
the buccal aspect of the
mandible

Oral Maxillo Facial Surge



IM-22-020-01
Adams
Napkin Holder
Napkin Holder
consisting of chain
and two crocodile forceps



IM-22-020-02
Langenbeck
7cm 2 3/4"
Finger Protector
21 mm Ø

IM-22-022-01
Mauder
9.5cm 3 3/4"
Mouth Gag
wood



IM-22-022-02
Pitha
Mouth Gag
28 x 30 mm
with chain silicone



Oral Maxillo Facial Surge



IM-22-024-13
Heister
13cm 5"
Mouth Gag



IM-22-024-11
Obwe geser
11cm 4 1/4"
Mouth Gag

Oral Maxillo Facial Surge



IM-22-026-11
Molt
11cm 4 1/4"
Mouth Gag



IM-22-026-14
Molt
13cm 5"
Mouth Gag

Oral Maxillo Facial Surge

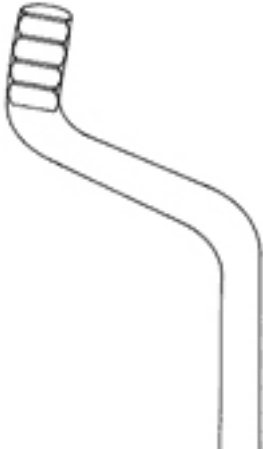

IM-22-030-16
Roser-König
16cm 6 1/4"
Mouth Gag

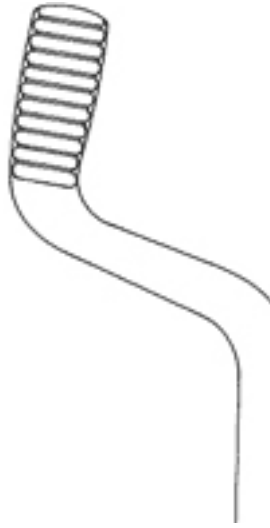

IM-22-030-20
Roser-König
20cm 8"
Mouth Gag



IM-22-030-13
Denhart
13cm 5"
Mouth Gag
jaws 16 mm

Oral Maxillo Facial Surge



IM-22-035-00
Kilner-Doughty
Mouth Gag
complete with frame,
3 tongue depressors,
2 tooth plates and 1 palate plate

Oral Maxillo Facial Surge



IM-22-040-01
Kilner-Doughty
13.5cm 5 1/4"
Tongue Depressor
70 x 29 mm
fenestrated blade for
suction Tongue Depressor



IM-22-040-02
Kilner-Doughty
13.5cm 5 1/4"
Tongue Depressor
80 x 34 mm
fenestrated blade for
suction Tongue Depressor



IM-22-040-03
Kilner-Doughty
13.5cm 5 1/4"
Tongue Depressor
85 x 38 mm
fenestrated blade for
suction Tongue Depressor

Oral Maxillo Facial Surge



IM-22-045-14
Kilner-Doughty
14.5cm 5 3/4"
Frame for Mouth Gag
Frame for Mouth Gag

Oral Maxillo Facial Surge



IM-22-050-00
Davis-Boyle
Mouth Gag complete,
consisting of frame
and five tongue
depressors no. 1 to 5

Oral Maxillo Facial Surge



IM-22-055-01
Davis-Boyle
13.5cm 5 1/4"
Tongue Depressor
110 x 26 mm
with fixed suction tube
Tongue Depressor

Oral Maxillo Facial Surge

IM-22-055-02
Davis-Boyle
13.5cm 5 1/4"
Tongue Depressor
95 x 25 mm
with fixed suction tube
Tongue Depressor



IM-22-055-03
Davis-Boyle
13.5cm 5 1/4"
Tongue Depressor
80 x 24 mm
with fixed suction tube
Tongue Depressor



IM-22-055-04
Davis-Boyle
13.5cm 5 1/4"
Tongue Depressor
65 x 23 mm
with fixed suction tube
Tongue Depressor



IM-22-055-05
Davis-Boyle
13.5cm 5 1/4"
Tongue Depressor
30 x 20 mm
without suction tube
Tongue Depressor

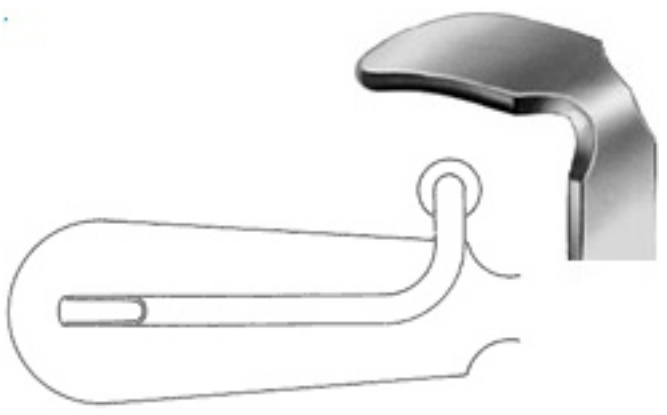

Oral Maxillo Facial Surge



IM-22-060-00
Davis-Boyle
13.5cm 5 1/4"
Tongue Depressor
30 x 20 mm
without suction tube
Tongue Depressor

IM-22-060-01
Davis-Boyle
14.5cm 5 3/4"
Frame for Mouth Gag
Frame for Mouth Gag

Oral Maxillo Facial Surge

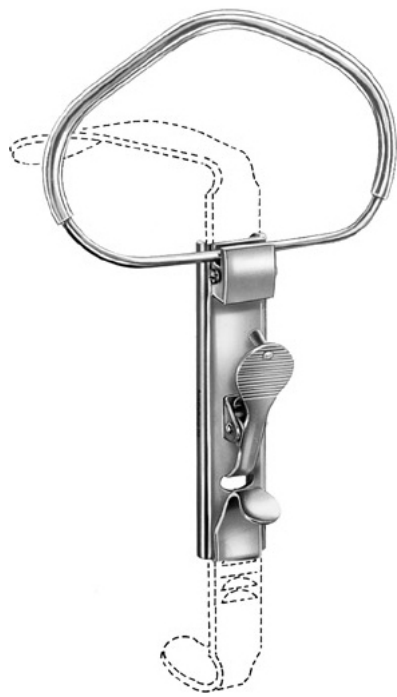

IM-22-065-00
Mclvor
Mouth Gagcomplete



IM-22-065-01
Mclvor
13.5cm 5 1/4"
Tongue Depressor
100 x 26 mm
Tongue Depressor

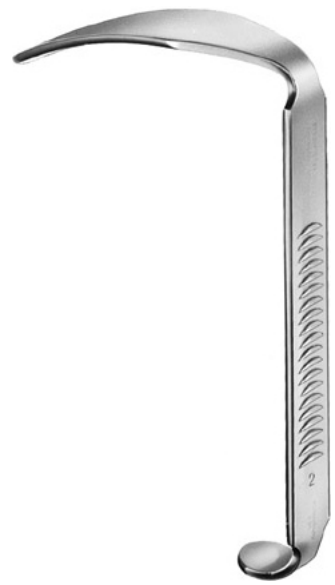

IM-22-065-02
Mclvor
13.5cm 5 1/4"
Tongue Depressor
85 x 25 mm
Tongue Depressor

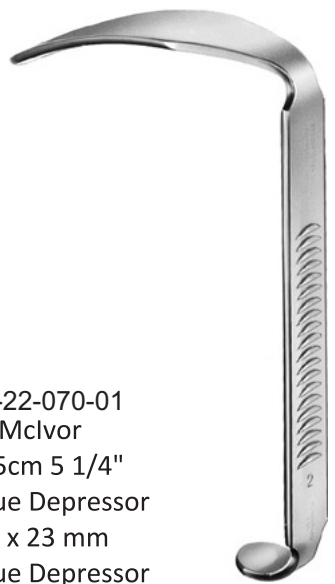

IM-22-070-01
Mclvor
13.5cm 5 1/4"
Tongue Depressor
75 x 23 mm
Tongue Depressor

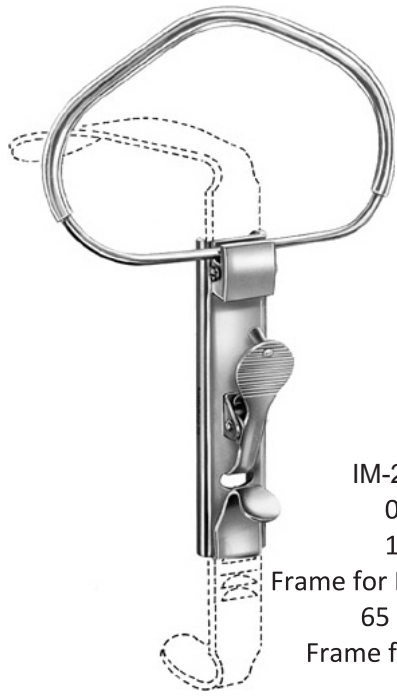

IM-22-070-00
OMclvor
15cm 6"
Frame for Mouth Gagframe
65 x 100 mm
Frame for Mouth Gag

Oral Maxillo Facial Surge

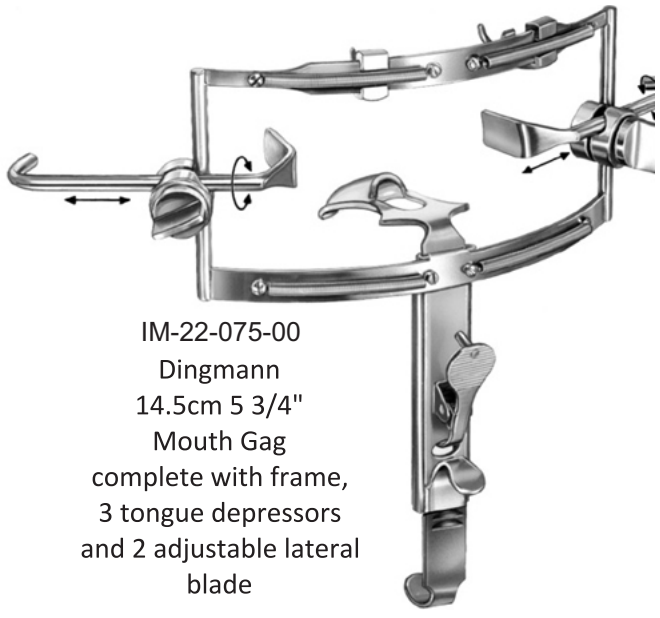

IM-22-075-00
Dingmann
14.5cm 5 3/4"
Mouth Gag
complete with frame,
3 tongue depressors
and 2 adjustable lateral
blade

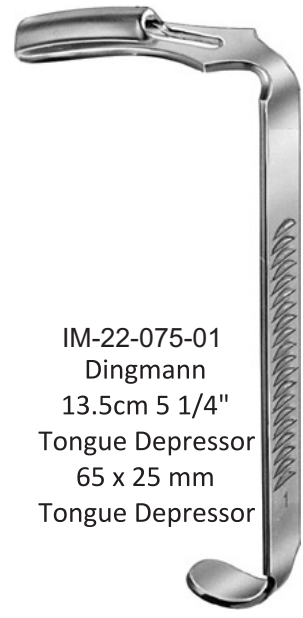

IM-22-075-01
Dingmann
13.5cm 5 1/4"
Tongue Depressor
65 x 25 mm
Tongue Depressor

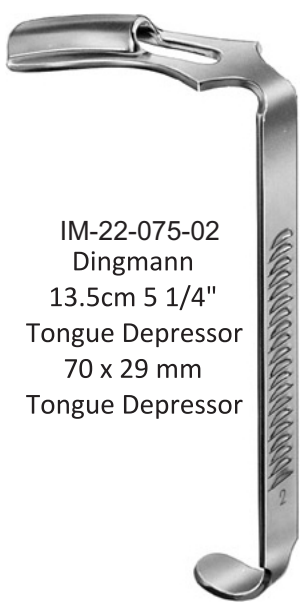

IM-22-075-02
Dingmann
13.5cm 5 1/4"
Tongue Depressor
70 x 29 mm
Tongue Depressor



IM-22-075-03
Dingmann
13.5cm 5 1/4"
Tongue Depressor
80 x 32 mm
Tongue Depressor

Oral Maxillo Facial Surge



IM-22-080-09
Jennings
10.5cm 4"
Mouth Gag

IM-22-080-11
Jennings
12.5cm 5"
Mouth Gag

IM-22-080-13
Jennings
14.5cm 5 3/4"
Mouth Gag

IM-22-080-15
Jennings
16.5cm 6 1/2"
Mouth Gag

Oral Maxillo Facial Surge

IM-22-085-00
ringer
9.5cm 3 3/4"
Lip and Cheek Retractor
95 mm
for childrenself-retaining



IM-22-085-01
Oringer
10cm 4 "
Lip and Cheek Retractor
110 mm
self-retaining

IM-22-085-02
ringer
10.5cm 4"
Lip and Cheek Retractor
115 mm
self-retaining

IM-22-085-03
Oringer
11cm 4 1/4"
Lip and Cheek Retractor
120 mm
self-retaining

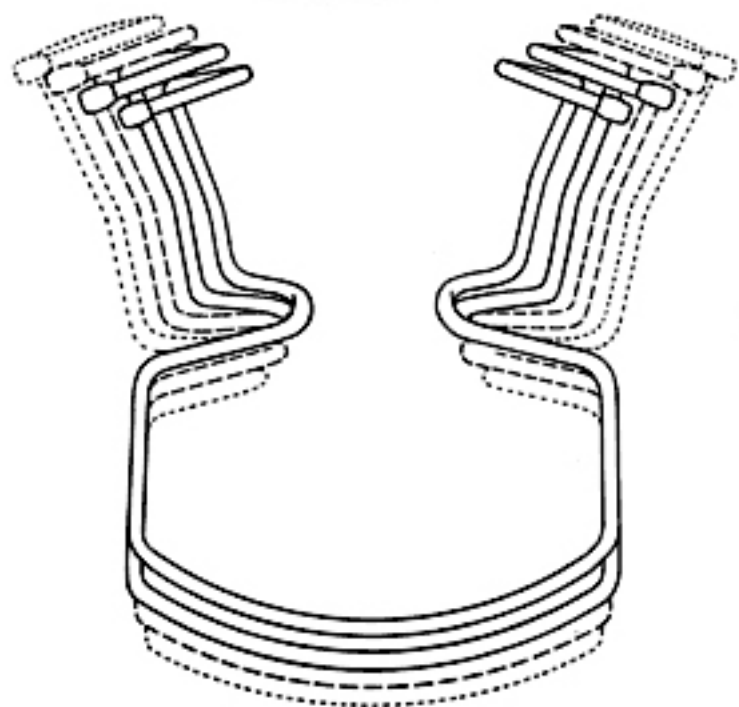

IM-22-087-03
Oringer
Lip and Cheek Retractor
set with no. 1-3
self-retaining

Oral Maxillo Facial Surge



IM-22-090-11
Martin-Simplex
10.5cm 4"
Cheek Retractor



IM-22-090-14
14cm 5 1/2"
Vestibulum Retractor
Vestibulum Retractor



IM-22-092-14
Sternberg
14cm 5 1/2"
Lip and Cheek
Retractor
26 / 37 mm

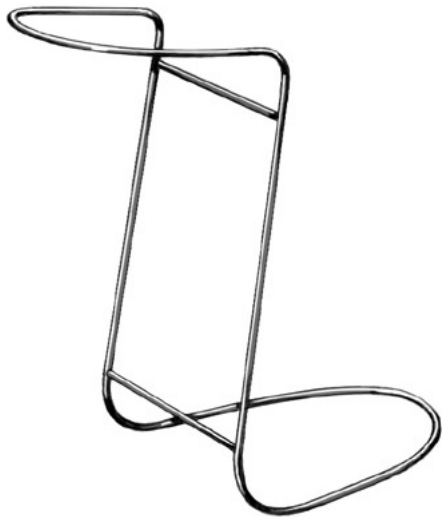

IM-22-093-12
Obwegeser
12cm 4 3/4"
Cheek Retractor



IM-22-094-13
Bishop
13.5cm 5 1/4"
Lip and Cheek Retractor

Oral Maxillo Facial Surge



IM-22-095-15
Cawood-Minnesota
15cm 6"
Cheek Retractor
20 mm



IM-22-097-00
14.5cm 5 3/4"
Cheek Retractor
fenestrated



Oral Maxillo Facial Surge



IM-22-100-15
Hartmann
15cm 6"
Tongue Depress or blade
72 x 23 mm

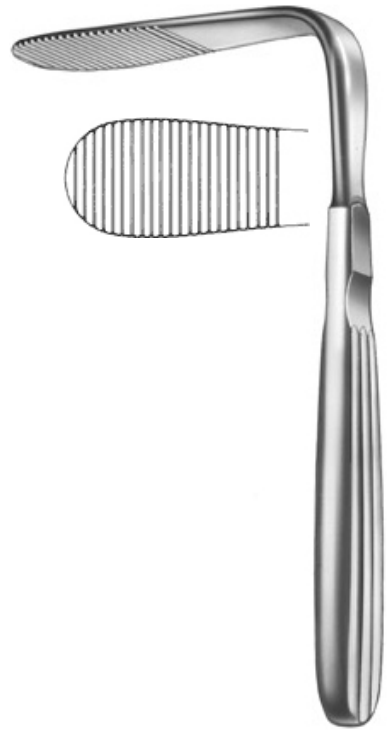

IM-22-100-14
Tobold
15cm 6"
Tongue Depress or blade
88 x 25 mm

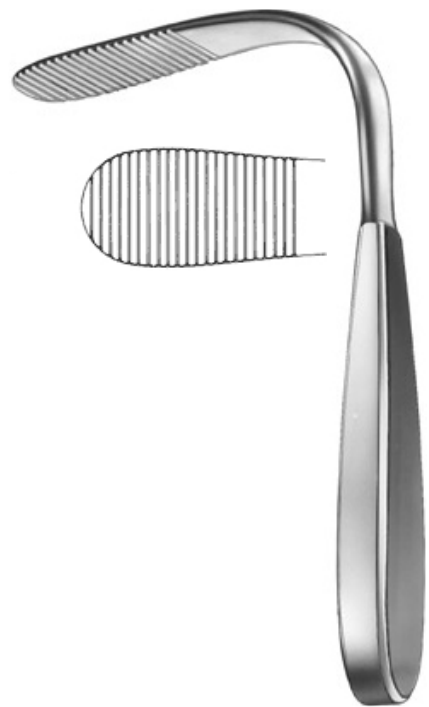

IM-22-102-14
Tobold
14.5cm 5 3/4"
Tongue Depress or blade
85 x 24 mm

Oral Maxillo Facial Surge

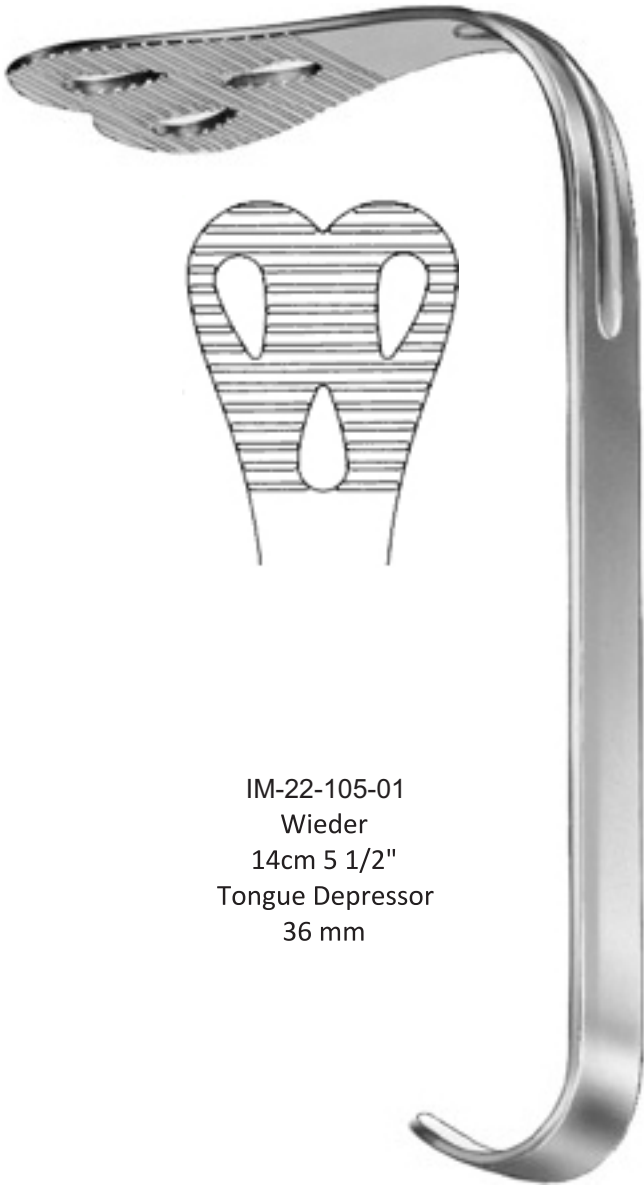

IM-22-105-01
Wieder
14cm 5 1/2"
Tongue Depressor
36 mm

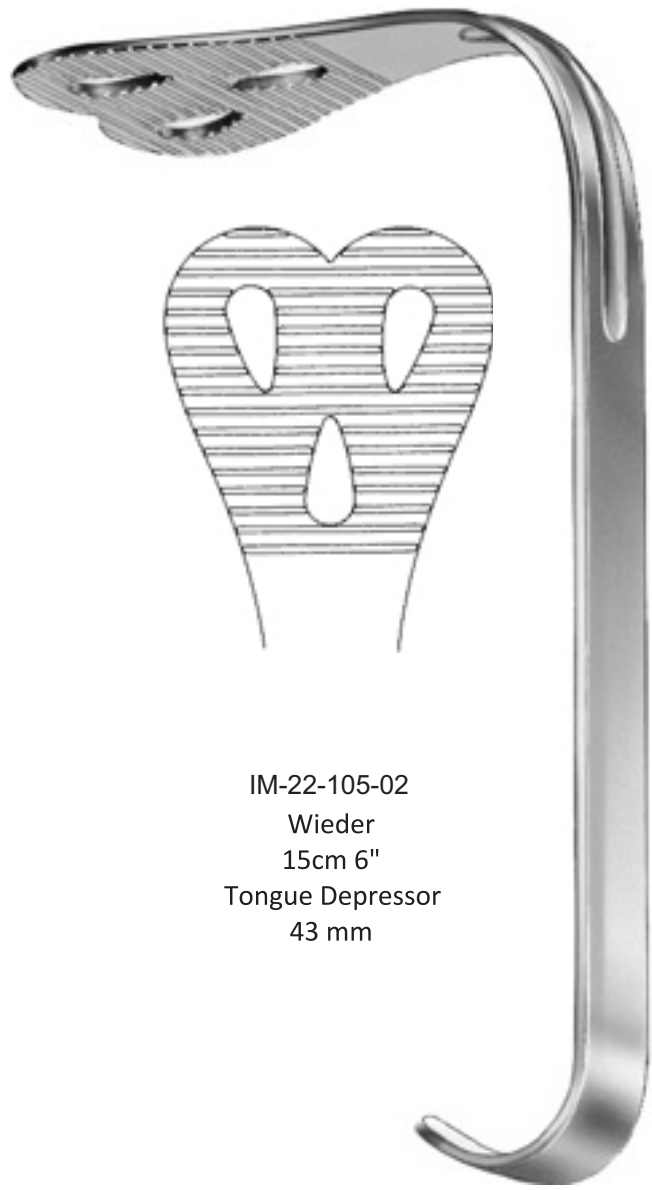

IM-22-105-02
Wieder
15cm 6"
Tongue Depressor
43 mm

Oral Maxillo Facial Surge



IM-22-110-16
16cm 6 1/4"
Tongue Spatula
package of 100
pieces wood



IM-22-110-15
15cm 6"
Tongue Spatula
package of 100
pieces plastic

Oral Maxillo Facial Surge



IM-22-115-18
Martin
18.5cm 7 1/4"
Tongue Spatula
nylon

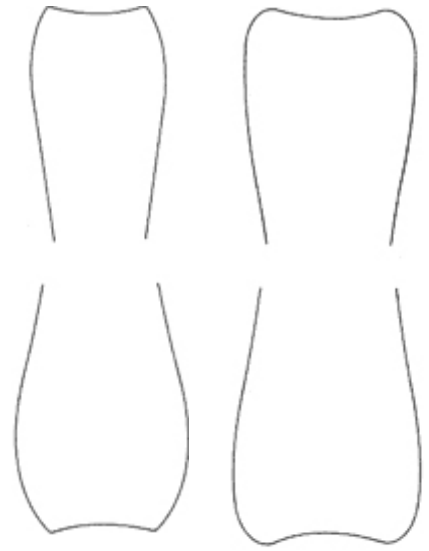

IM-22-115-13
Doyen
13.5cm 5 1/4"
Tongue Spatula

IM-22-115-16
Doyen
16cm 6 1/4"
Tongue Spatula



IM-22-115-19
Brünings
19cm 7 1/2"
Tongue Spatula

Oral Maxillo Facial Surge



IM-22-120-17
Collin
17cm 6 3/4"
Tongue Holding Forceps
jaw 24 x 27 mm

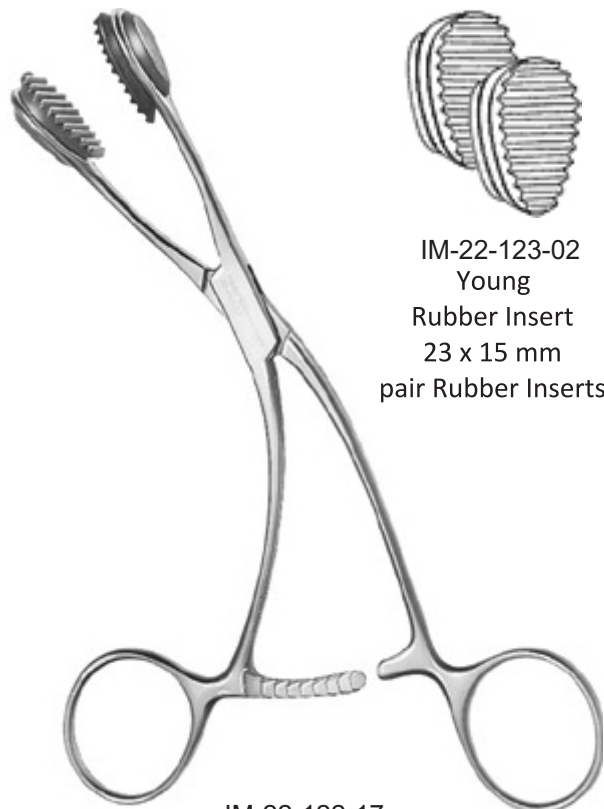

IM-22-123-02
Young
Rubber Insert
23 x 15 mm
pair Rubber Inserts

IM-22-122-17
Young
15cm 6"
Tongue Holding Forceps

Oral Maxillo Facial Surge



IM-22-125-24
22cm 8 3/4" Extra Oral Retractor
9,5 mm / 16 mm
concave blade, fully bent tip

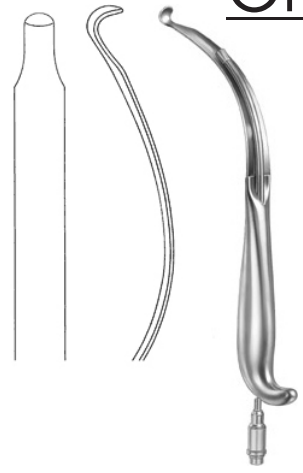

IM-22-125-27
25.5cm 10" Extra Oral Retractor
9,5 mm / 16 mm concave blade,
fully bent tip with fiber optic light carrier

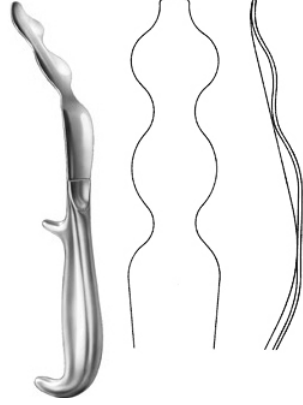

IM-22-127-24
23cm 9"
Intra Oral Retractor
25,5 mm
for LeFort osteotomies



IM-22-127-27
27cm 10 3/4"
Intra Oral Retractor 25,5 mm
for LeFort osteotomies
with fiber optic light carrier



IM-22-127-21R
21cm 8 1/4" Intra Oral Retractor
26,5 / 16 mm right



IM-22-127-21L
21cm 8 1/4" Intra Oral Retractor
26,5 / 16 mm left

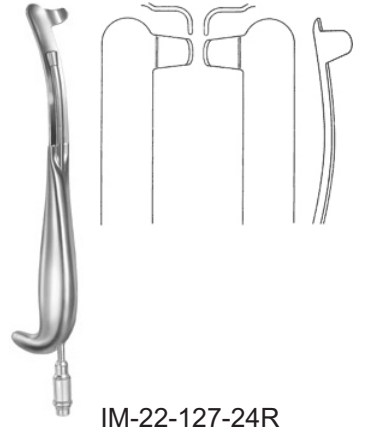

IM-22-127-24R
24.5cm 9 3/4" Intra Oral Retractor
26,5 / 16 mm right with
fiber optic light carrier

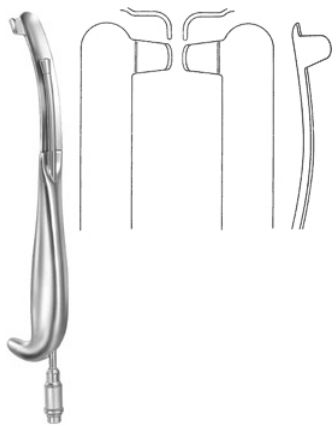

IM-22-127-24L
24.5cm 9 3/4" Intra Oral Retractor
26,5 / 16 mm left with
fiber optic light carrier

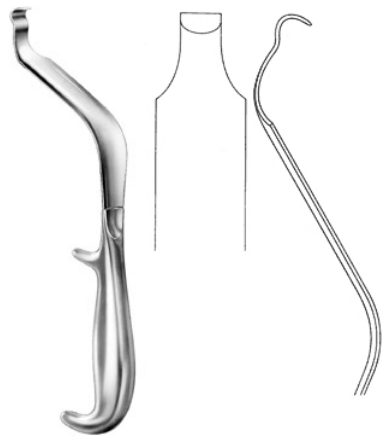

IM-22-130-25
25cm 9 3/4" Intra Oral Retractor
12,5 / 27 mm L&M,
for vertical osteotomy

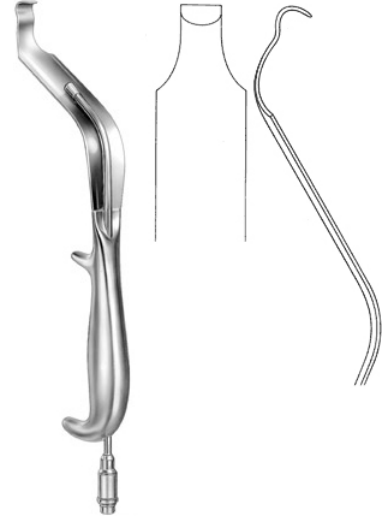

IM-22-130-28
28cm 11" Intra Oral Retractor
12,5 / 27 mm L&M, for vertical osteoto
my with fiber optic light carrier

Oral Maxillo Facial Surge

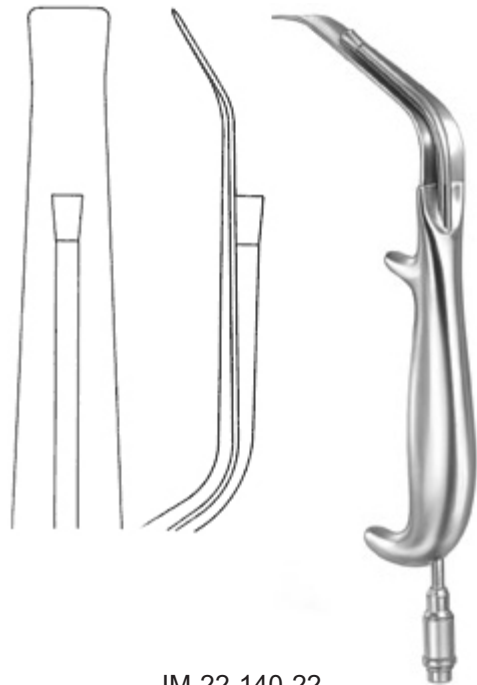

IM-22-140-22
Shea
22cm 8 3/4"
Multi purpose
Retractor 14,5 mm
with fiber optic light carrier
Multi Purpose Retractor



IM-22-145-24
bwegeser
21.5cm 8 1/2"
Soft Tissue Retractor
blade 43 x 11 mm

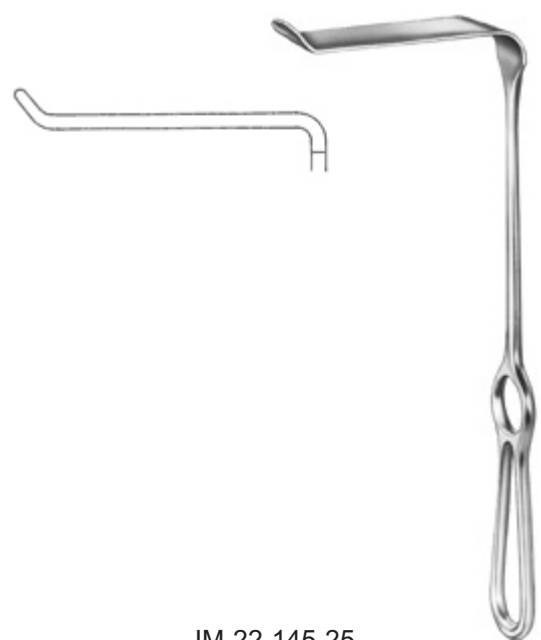

IM-22-145-25
Obwegeser
21.5cm 8 1/2"
Soft Tissue Retractor
blade 57 x 11 mm

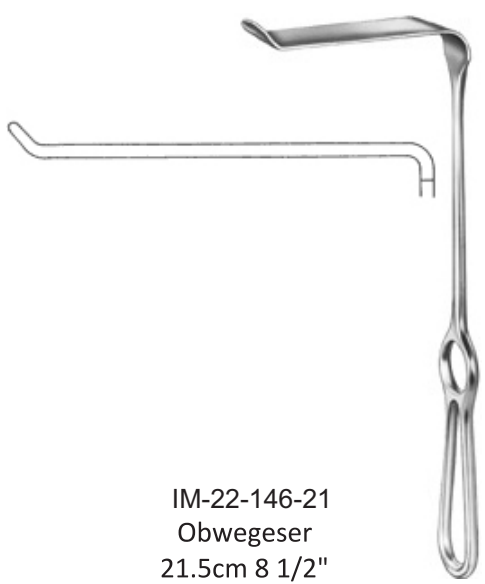

IM-22-146-21
Obwegeser
21.5cm 8 1/2"
Soft Tissue Retractor
blade 83 x 16 mm

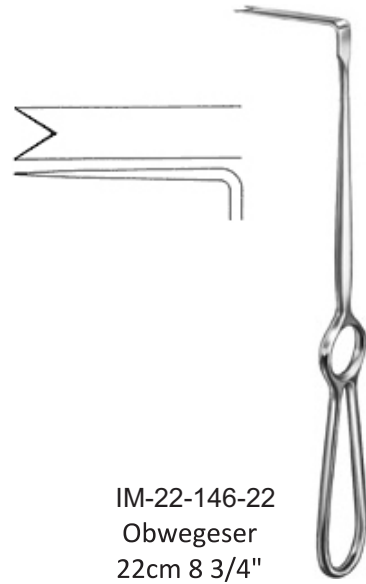

IM-22-146-22
Obwegeser
22cm 8 3/4"
Nasal Spine Retractor
blade 45 x 10 mm
Nasal Spine Retractor

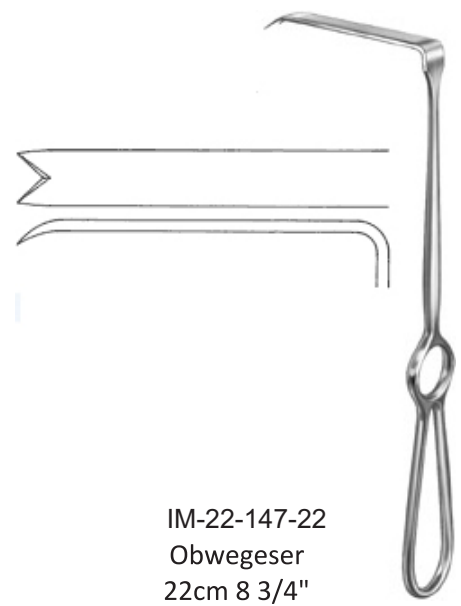

IM-22-147-22
Obwegeser
22cm 8 3/4"
Ramus Retractor
blade 72 x 10 mm

Oral Maxillo Facial Surge



IM-22-150-16
Obwegeser
16.5cm 6 1/2"
Chin Retractor



IM-22-155-01
Obwegeser
17cm 6 3/4"
Channel Retractor
8 mm

IM-22-155-02
Obwegeser
17cm 6 3/4"
Channel Retractor
10 mm

Oral Maxillo Facial Surge

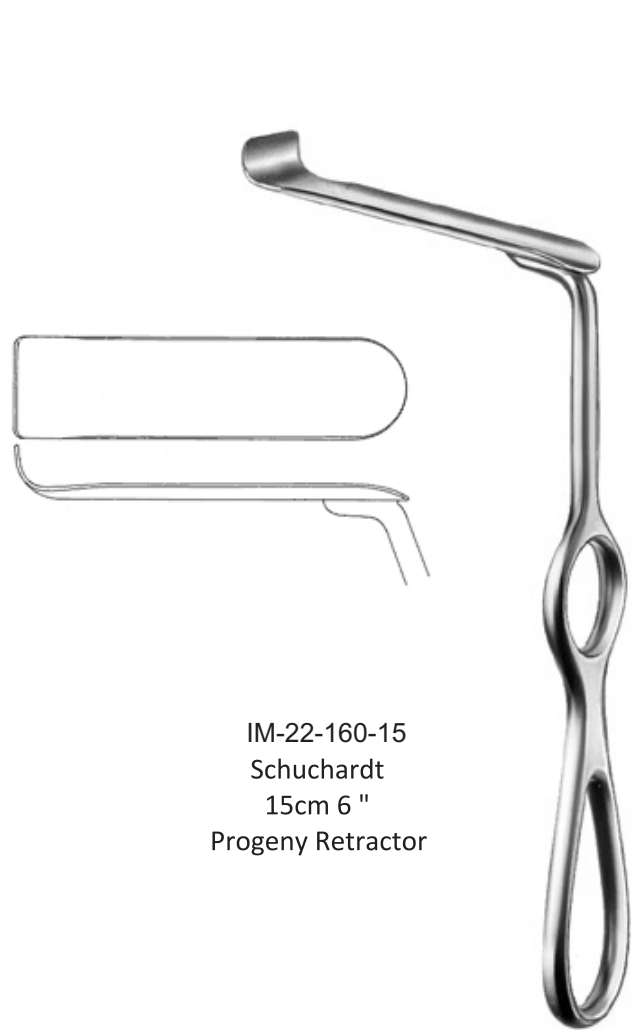

IM-22-160-15
Schuchardt
15cm 6 "
Progeny Retractor



IM-22-160-20
Metz
15cm 6 "
Progeny Retractor

Oral Maxillo Facial Surge



IM-22-165-01
18.5cm 7 1/4"
Retractor 14 x 7 mm

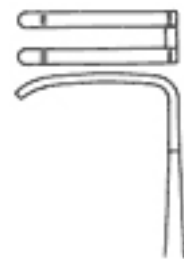

IM-22-165-02
Koberg, mod.
18.5cm 7 1/4"
Retractor 20 x 7 mm

Oral Maxillo Facial Surge



IM-22-170-01
18cm 7"
Periosteal Elevator
3 x 18 mm

IM-22-170-02
18cm 7"
Periosteal Elevator
3,5 x 23 mm

Oral Maxillo Facial Surge

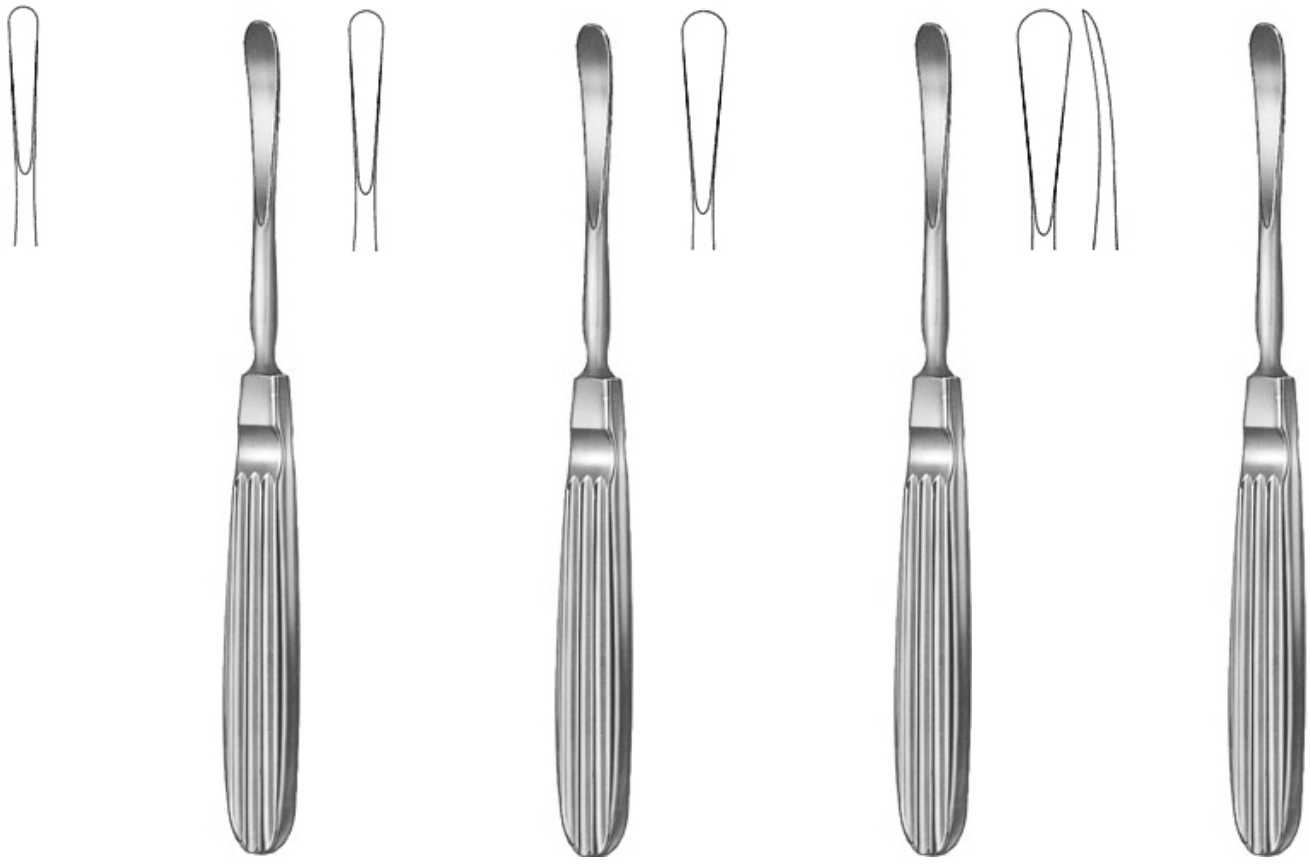

IM-22-175-01
Obwegeser
17.5cm 7"
Periosteal Elevator
6 mm

IM-22-175-02
Obwegeser
17.5cm 7"
Periosteal Elevator
7 mm

IM-22-175-03
Obwegeser
17.5cm 7"
Periosteal Elevator
9 mm

IM-22-175-04
Obwegeser
17.5cm 7"
Periosteal Elevator
11 mm

Oral Maxillo Facial Surge



IM-22-180-01
Obwegeser
20.5cm 8"
Periosteal Elevator
5 mm

IM-22-180-02
Obwegeser
20.5cm 8"
Periosteal Elevator
7 mm

IM-22-180-03
Obwegeser
20.5cm 8"
Periosteal Elevator
9 mm

Oral Maxillo Facial Surge

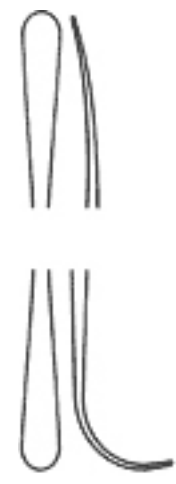
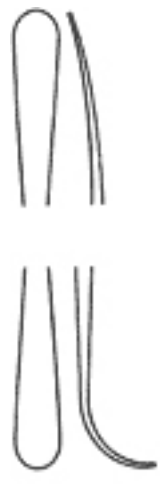

IM-22-185-01
Obwegeser
17.5cm 7"
Periosteal Elevator

IM-22-185-02
Obwegeser
17.5cm 7"
Periosteal Elevator

IM-22-190-21
Obwegeser
20.5cm 8"
Elevator

IM-22-190-20
Obwegeser
20.5cm 8"
Elevator

Oral Maxillo Facial Surge

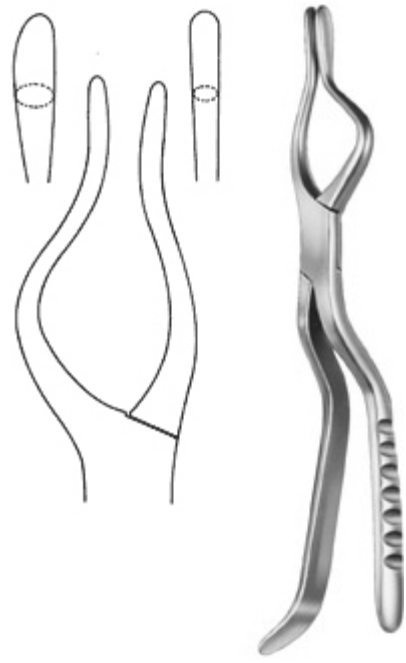

IM-22-200-01
Rowe
22.5cm 9"
Disimpaction Forceps
left L

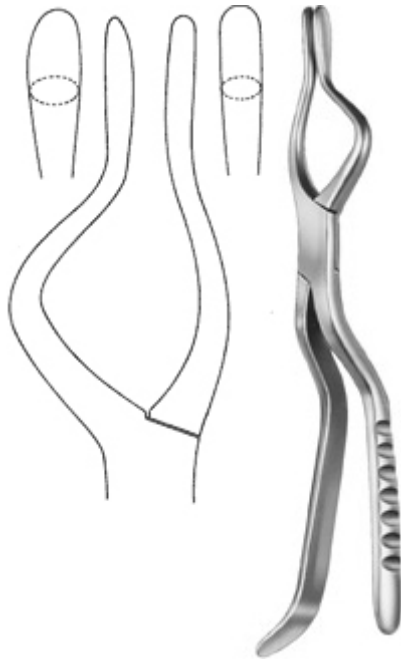

IM-22-200-02
Rowe
23.5cm 9 1/4"
Disimpaction Forceps
left L

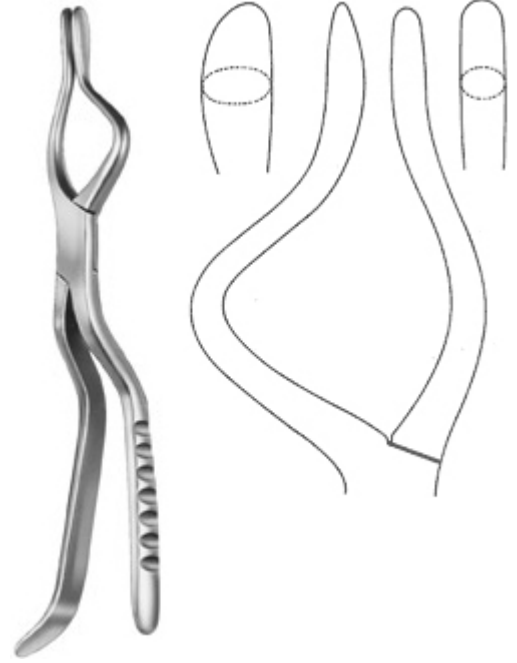

IM-22-200-03
Rowe
24cm 9 1/2"
Disimpaction Forceps
left L

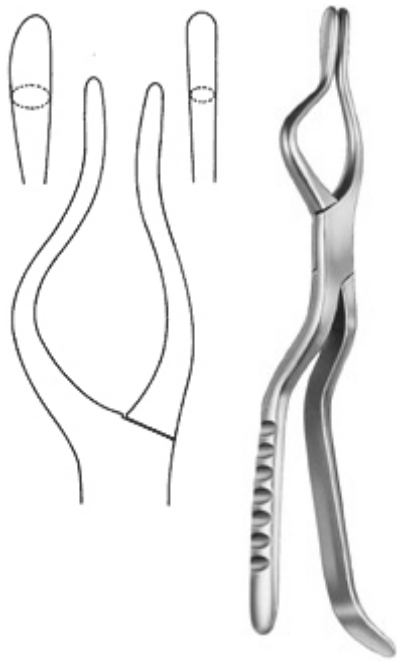

IM-22-205-01
Rowe
22.5cm 9"
Disimpaction Forceps
right R

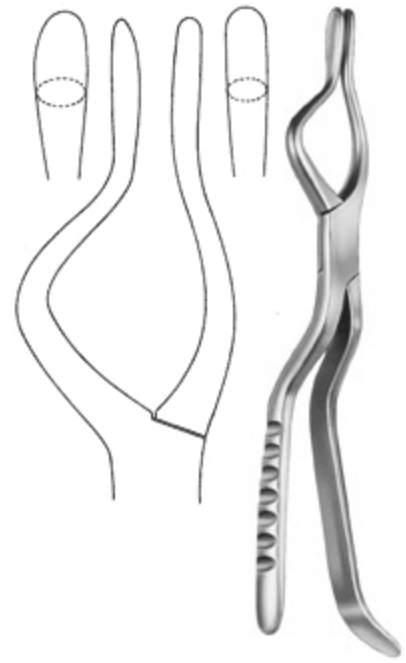

IM-22-205-02
Rowe
23.5cm 9 1/4"
Disimpaction Forceps
right R

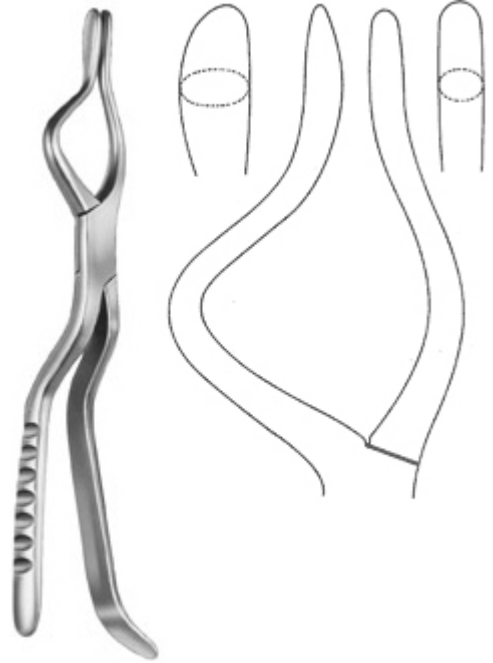

IM-22-205-03
Rowe
24cm 9 1/2"
Disimpaction Forceps
right R

Oral Maxillo Facial Surge



IM-22-210-21
Gillies
20cm 8"
Zygoma Elevator



IM-22-215-20
Dingmann
21cm 8 1/4"
Zygoma Elevator
tip 5,0 mm Ø



IM-22-220-20
Dingmann-Wilk
20cm 8"
Retractor
ZI-38-718-01
Jeter-Van Sickels
18cm 7"
Bone Holding Forceps
light pattern
for sagittal split procedure

Oral Maxillo Facial Surge



IM-22-225-18
Jeter-Van Sickels
18cm 7"
Bone Holding Forceps
heavy pattern
for sagittal split procedure

Oral Maxillo Facial Surge



IM-22-230-01
Keen
17.5cm 6 3/4"
Bone Holding Forceps
left

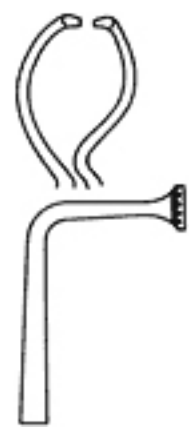

IM-22-230-02
Keen
17.5cm 6 3/4"
Bone Holding Forceps
right



Oral Maxillo Facial Surge



IM-22-235-01
Steinhäuser
13cm 5"
Bone Holding Forceps



IM-22-235-02
Steinhäuser
13cm 5"
Bone Holding Forceps
bent downwards

Oral Maxillo Facial Surge

IM-22-240-00
Arnhem
22cm 8 3/4"
LeFort I Retractor
right LeFort I Retractor

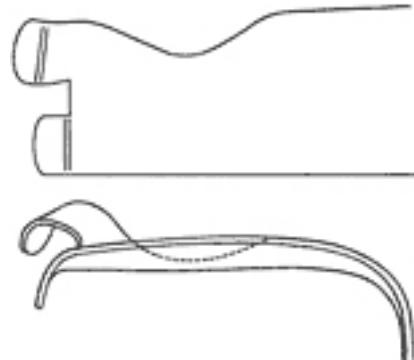

IM-22-240-01
Arnhem
22cm 8 3/4"
LeFort I Retractor
left LeFort I Retractor

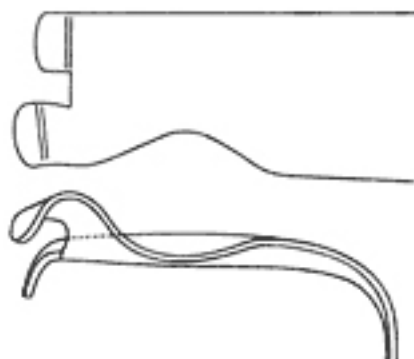

IM-22-240-02
Arnhem
22cm 8 3/4"
Sinus Lift Retractor right
Sinus Lift Retractor

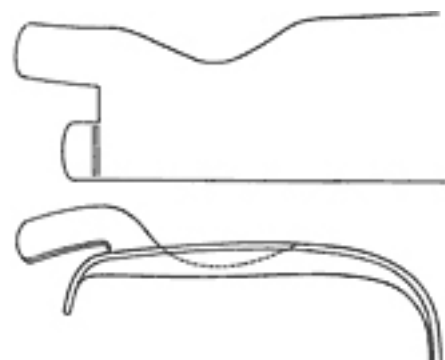

IM-22-240-03
Arnhem
22cm 8 3/4"
Sinus Lift Retractor left

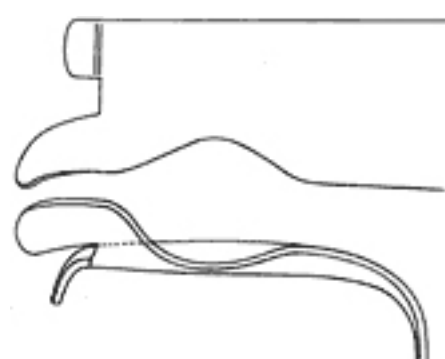

Oral Maxillo Facial Surge



IM-22-245-00
Bauer
20.5cm 8"
Osteotome
6 mm



IM-22-245-01
Bauer
20.5cm 8"
Osteotome
8 mm



IM-22-247-00
Bauer
20.5cm 8"
Osteotome
6 mm



IM-22-247-01
Bauer
20.5cm 8"
Osteotome
8 mm

Oral Maxillo Facial Surge



IM-22-245-00
Bauer
20.5cm 8"
Osteotome
6 mm

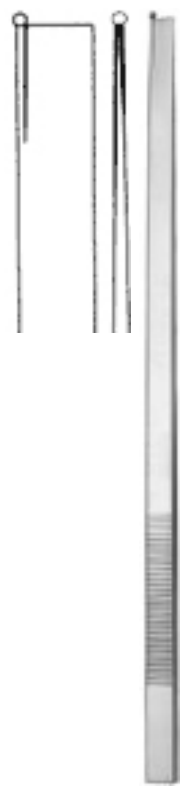

IM-22-245-01
Bauer
20.5cm 8"
Osteotome
8 mm



IM-22-247-00
Bauer
20.5cm 8"
Osteotome
6 mm



IM-22-247-01
Bauer
20.5cm 8"
Osteotome
8 mm

Oral Maxillo Facial Surge



IM-22-250-01
Epker-Bauer
17.5cm 7"
Osteotome
8 mm

Oral Maxillo Facial Surge



IM-22-255-01
Dautrey-Munro
16cm 6 1/4"
Osteotome 4 mm



IM-22-255-02
Dautrey-Munro
16cm 6 1/4"
Osteotome 6 mm



IM-22-255-03
Dautrey-Munro
16cm 6 1/4"
Osteotome 8 mm



IM-22-255-04
Dautrey-Munro
16cm 6 1/4"
Osteotome 10 mm



IM-22-255-05
Dautrey-Munro
16cm 6 1/4"
Osteotome 12 mm



IM-22-255-06
Dautrey-Munro
16cm 6 1/4"
Osteotome 14 mm



IM-22-255-07
Dautrey-Munro
16cm 6 1/4"
Osteotome 16 mm

Oral Maxillo Facial Surge



IM-22-260-04
Dunn-Dautrey
16.5cm 6 ½"
Osteotome
4 mm



IM-22-260-06
Dunn-Dautrey
16.5cm 6 ½"
Osteotome
6 mm



IM-22-260-08
Dunn-Dautrey
16.5cm 6 ½"
Osteotome
8 mm

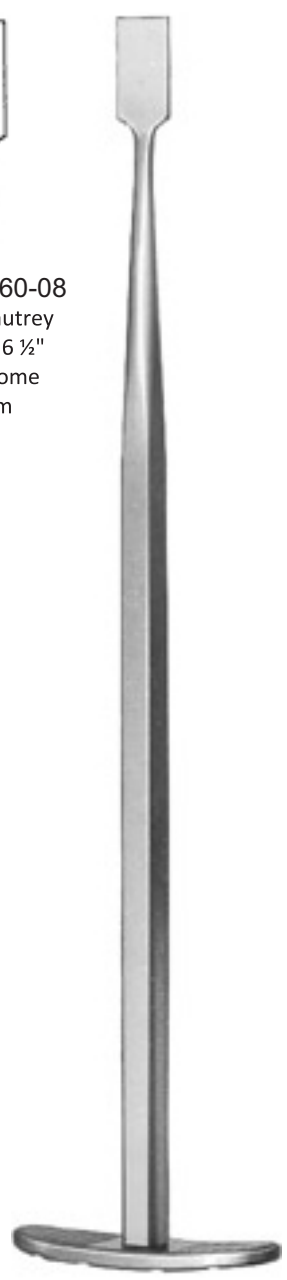

IM-22-262-01
Dunn-Dautrey
17cm 6 ¾"
Osteotome
6 mm



IM-22-262-02
Dunn-Dautrey
17cm 6 ¾"
Osteotome
6 mm



Oral Maxillo Facial Surge



IM-22-265-01
Epker
18cm 7"
Osteotome
4 x 1,2 mm



IM-22-265-02
Epker
18cm 7"
Osteotome
6 x 1,2 mm



IM-22-265-03
Epker
18cm 7"
Osteotome
8 x 1,2 mm



IM-22-267-01
Epker
18cm 7"
Osteotome
4 x 1,2 mm

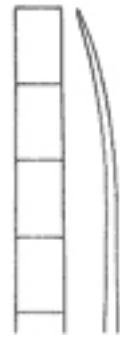

IM-22-267-01
Epker
18cm 7"
Osteotome
6 x 1,2 mm



Oral Maxillo Facial Surge



IM-22-270-01
Epker
18cm 7"
Osteotome
6 x 1,2 mm



IM-22-270-02
Epker
18cm 7"
Osteotome
8 x 1,2 mm



Oral Maxillo Facial Surge

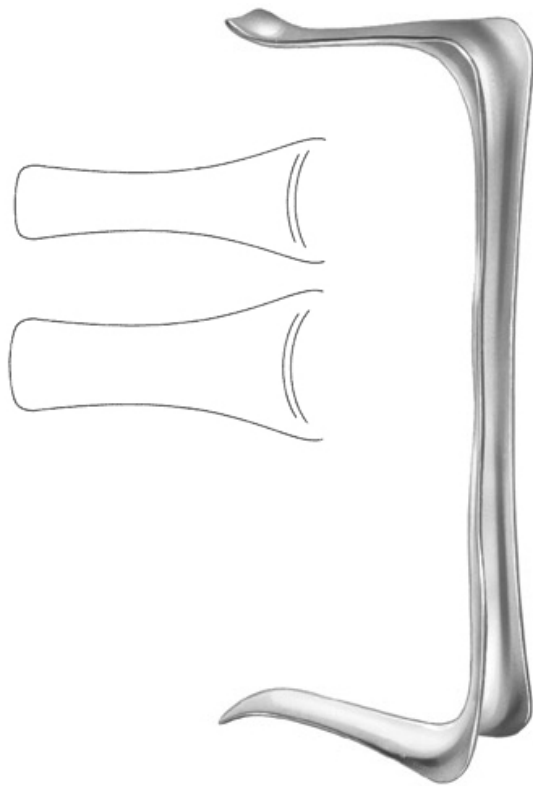

IM-22-275-16
Hargis
16cm 6 1/4"
Lip and Cheek Retractor

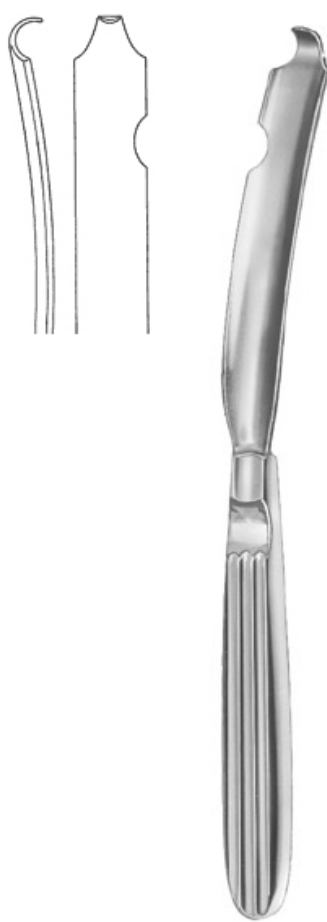

IM-22-280-01
Hargis
19.5cm 7 3/4"
Ramus Retractor right

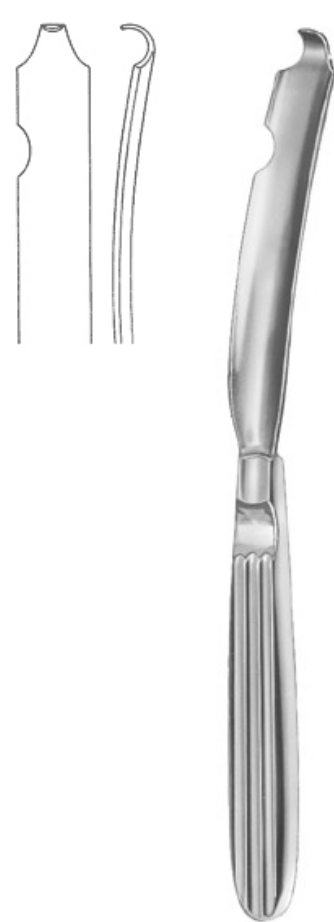

IM-22-280-01
Hargis
19.5cm 7 3/4"
Ramus Retractor left

Oral Maxillo Facial Surge



IM-22-285-01
Hargis
18cm 7"
Mandibular Body Retractor

IM-22-285-02
Hargis
19cm 7 1/2"
Anterior Border Stripper

Oral Maxillo Facial Surge

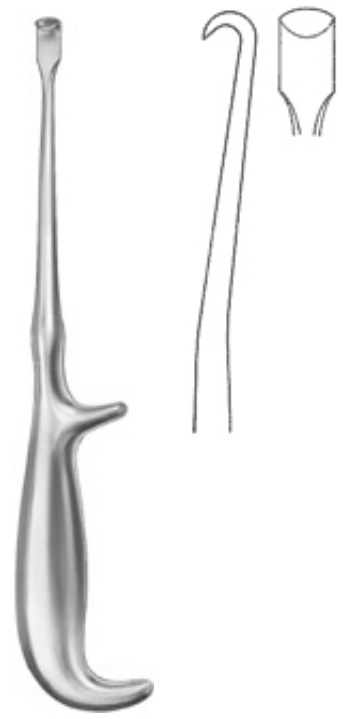

IM-22-290-01
Hargis
23cm 9"
Periosteal Elevator
6,5 mm right

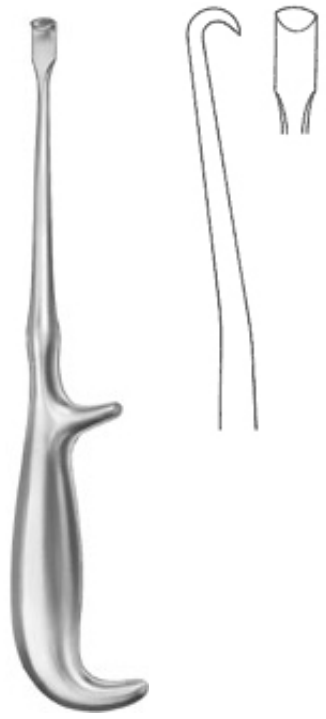

IM-22-290-02
Hargis
23cm 9"
Periosteal Elevator
9 mm right



IM-22-290-03
Hargis
23cm 9"
Periosteal Elevator
6,5 mm left

Oral Maxillo Facial Surge



IM-22-295-23
Hargis
23cm 9"
Periosteal Elevator
9 mm left

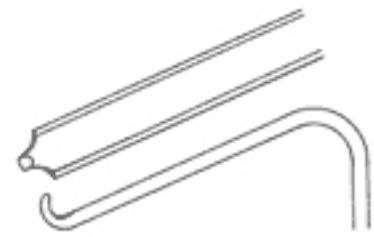

IM-22-300-18
Hargis
18.5cm 7 1/4"
Periform Rim Retractor

Oral Maxillo Facial Surge



IM-22-305-18
Hargis
22cm 8 3/4"
Pterygoid Osteotome

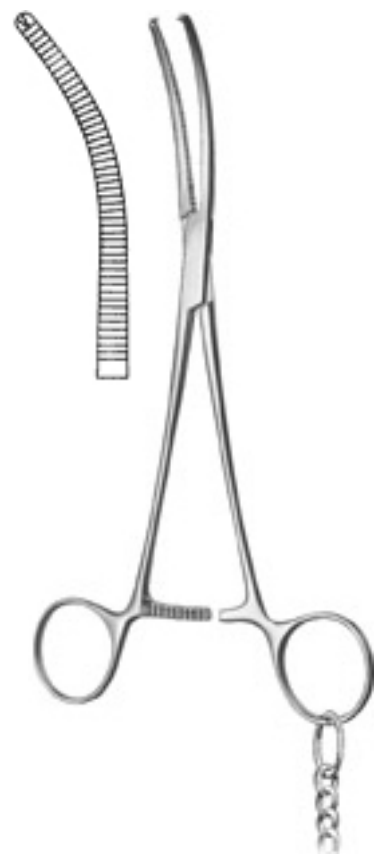

IM-22-310-19
Hargis
19cm 7 1/2"
Bone Holding Forceps
1:2 teeth with chain



IM-22-310-20
Hargis
Retractor Chain
Retractor Chain, only

Oral Maxillo Facial Surge

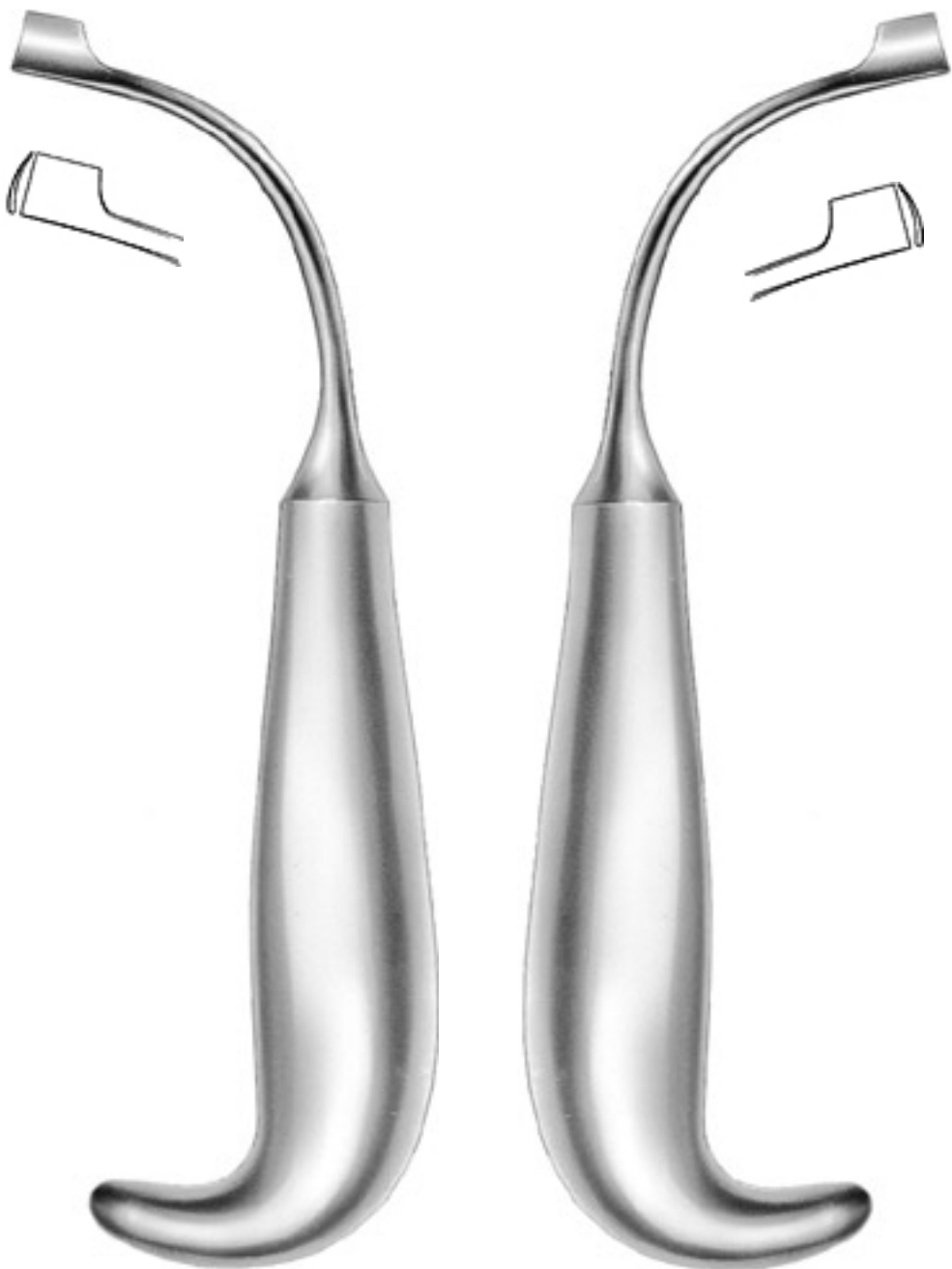

IM-22-315-01
Smith
18.5cm 7 1/4"
Sagittal Split Separator
9 mm right

IM-22-315-02
Smith
18.5cm 7 1/4"
Sagittal Split Separator
9 mm left



IM-22-320-24
Smith
23.5cm 9 1/4"
Ramus Separator

Oral Maxillo Facial Surge

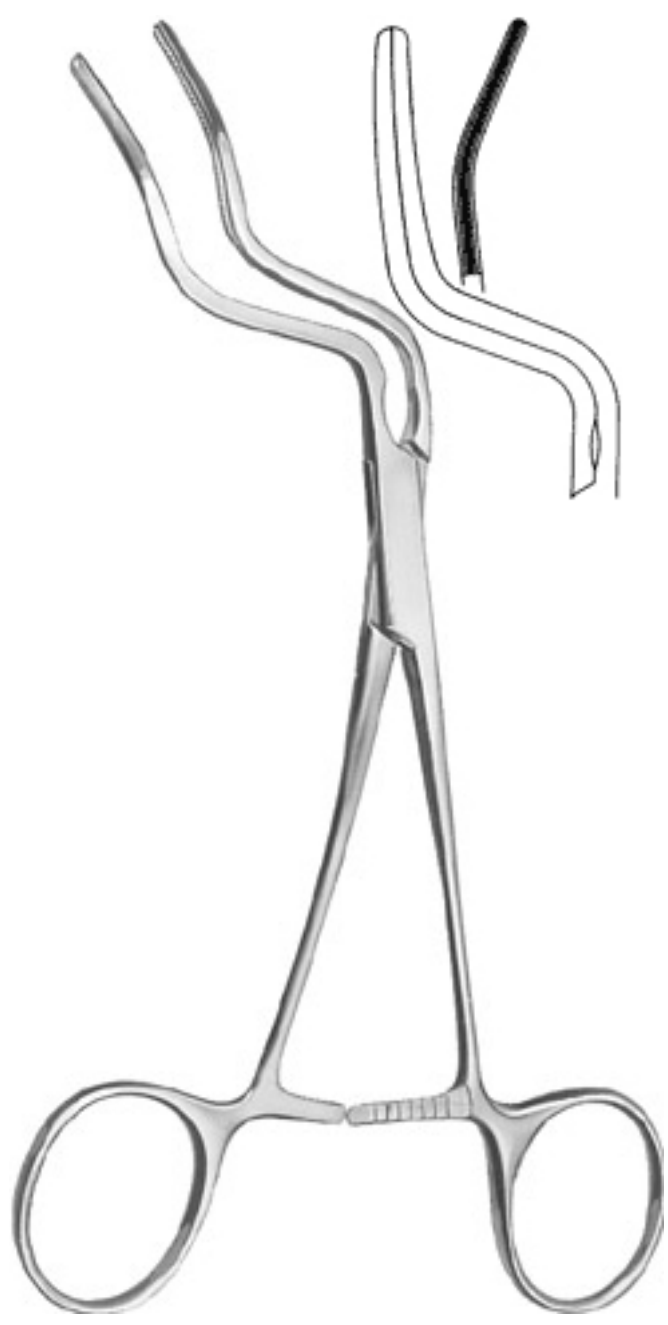

IM-22-325-01
Terry
17cm 6 3/4"
Mylohyoid Muscle Clamp left



IM-22-325-02
Terry
17cm 6 3/4"
Mylohyoid Muscle Clamp right

Oral Maxillo Facial Surge



IM-22-330-16
Terry
16.5cm 6 1/2"
Mandibular Retractor

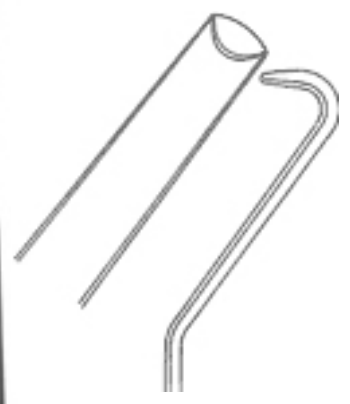

IM-22-335-24
Terry
24cm 9 1/2"
Ramus Pusher



IM-22-335-17
Terry
17cm 6 3/4"
Wire Introducer



Oral Maxillo Facial Surge



IM-22-340-19
Terry
19cm 7 1/2"
Septal Osteotome



IM-22-345-14
Terry
14cm 5 1/2"
Occlusal Wedge



IM-22-350-01
Terry
15cm 6"
Duct Retractor left



IM-22-350-01
Terry
15cm 6"
Duct Retractor right

Oral Maxillo Facial Surge



IM-22-355-17
Turvey
17cm 6 3/4"
Palatal Expander

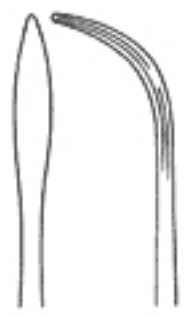

IM-22-360-18
Steinhäuser
18.5cm 7 1/4"
Elevator

Oral Maxillo Facial Surge

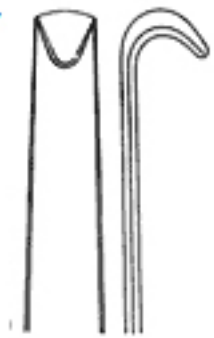

IM-22-365-27
Steinhäuser
27cm 10 1/2"
Mandibular Retractor
extra long

Oral Maxillo Facial Surge

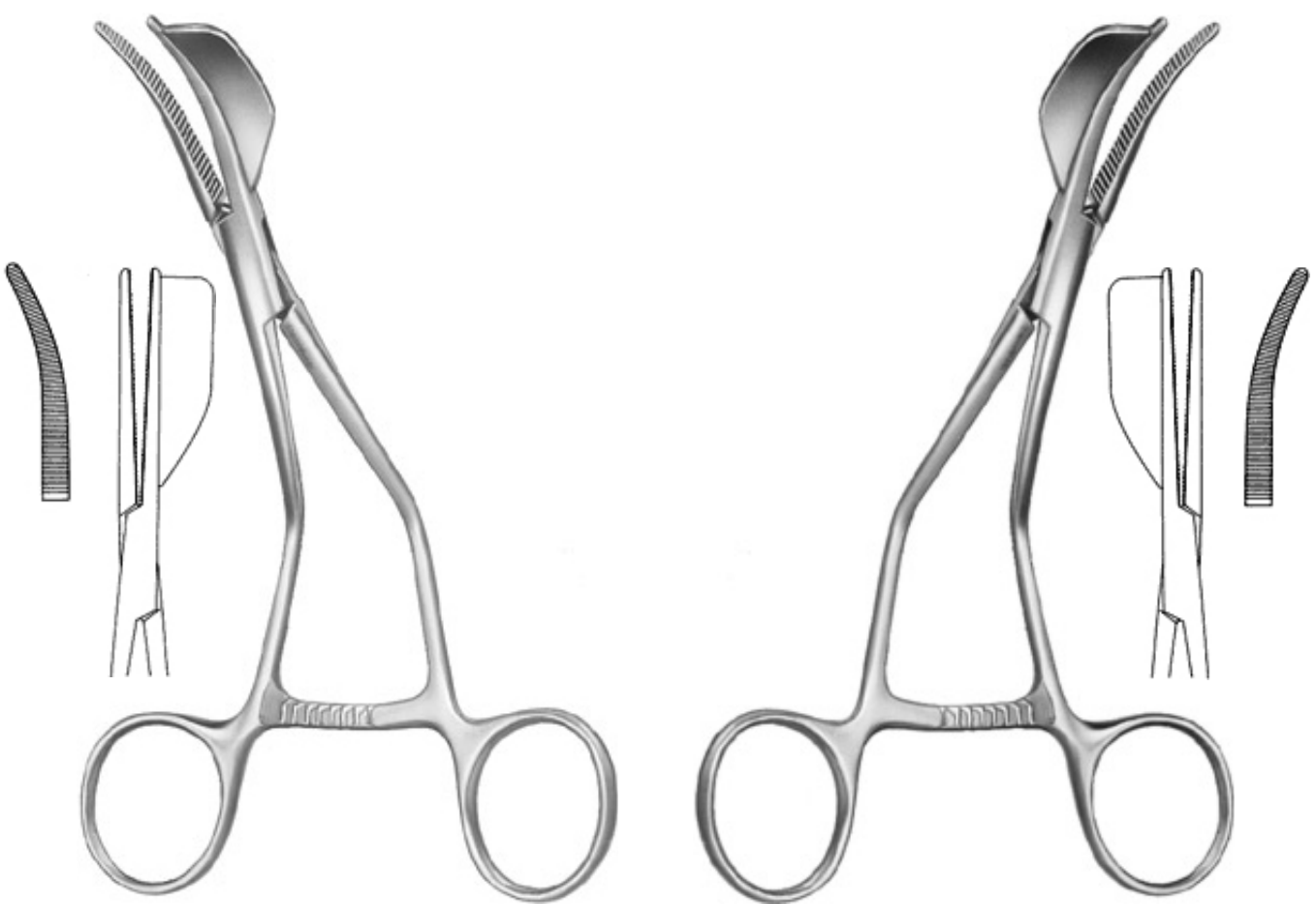

IM-22-370-01
Steinhäuser
16cm 6 1/4"
Ramus Clamp right

IM-22-370-02
Steinhäuser
16cm 6 1/4"
Ramus Clamp left

Oral Maxillo Facial Surge



IM-22-375-01
Steinhäuser
17cm 6 3/4"
Ramus Osteotome
7 mm flexible



IM-22-375-02
Steinhäuser
17cm 6 3/4"
Ramus Osteotome
10 mm flexible



Oral Maxillo Facial Surge



IM-22-380-01
Steinhäuser
19cm 7 ½"
Chisel
7 mm flexible



IM-22-380-02
Steinhäuser
19cm 7 ½"
Chisel
11 mm flexible



IM-22-380-02
Steinhäuser
19cm 7 ½"
Chisel 15 mm
flexible



Oral Maxillo Facial Surge



IM-22-385-18
Steinhäuser
18cm 7"
Reposition Instrument
Reposition Instrument



IM-22-390-01
16cm 6 1/4"
Periosteal Elevator
6 x 12 mm



IM-22-390-02
16.5cm 6 1/2"
Periosteal Elevator
6 x 19 mm



IM-22-390-03
17cm 6 3/4"
Periosteal Elevator
6 x 26 mm



Oral Maxillo Facial Surge

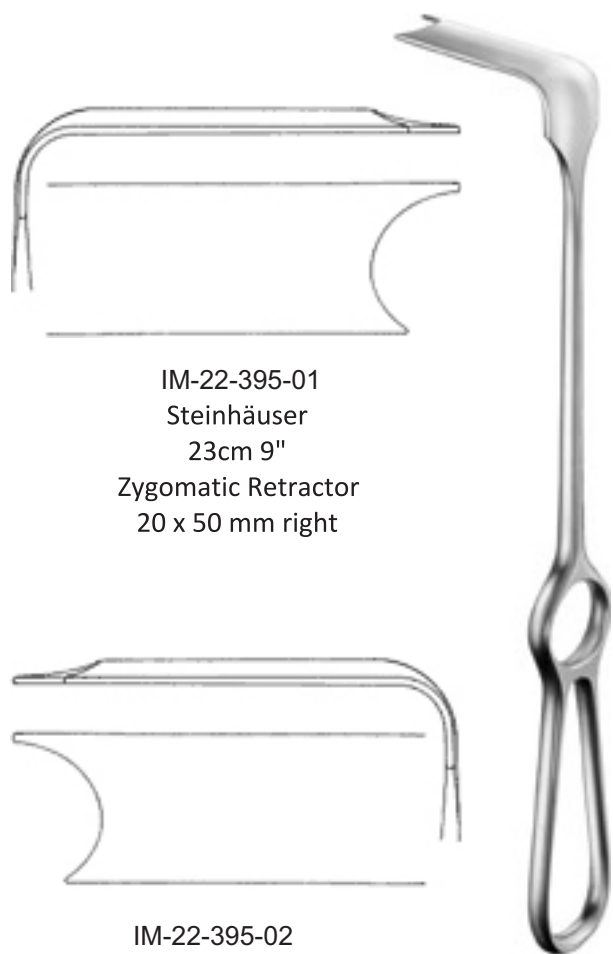

IM-22-395-01
Steinhäuser
23cm 9"
Zygomatic Retractor
20 x 50 mm right

IM-22-395-02
Steinhäuser
23cm 9"
Zygomatic Retractor
20 x 50 mm left



IM-22-400-16
Steinhäuser
16.5cm 6 1/2"
Orbital Raspatory 3 mm

Oral Maxillo Facial Surge

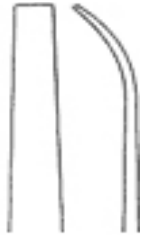

IM-22-405-01
teinhäuser
18cm 7"
Orbital Osteotome
5 mm

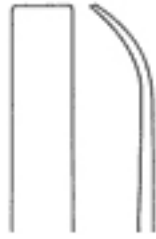

IM-22-405-02
Steinhäuser
18cm 7"
Orbital Osteotome
8 mm



Oral Maxillo Facial Surge

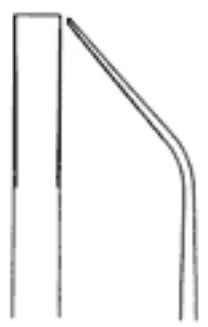

IM-22-410-06
Wolford
23cm 9"
Osteotome 6 mm

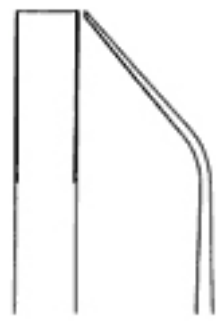

IM-22-410-08
Wolford
23cm 9"
Osteotome 8 mm

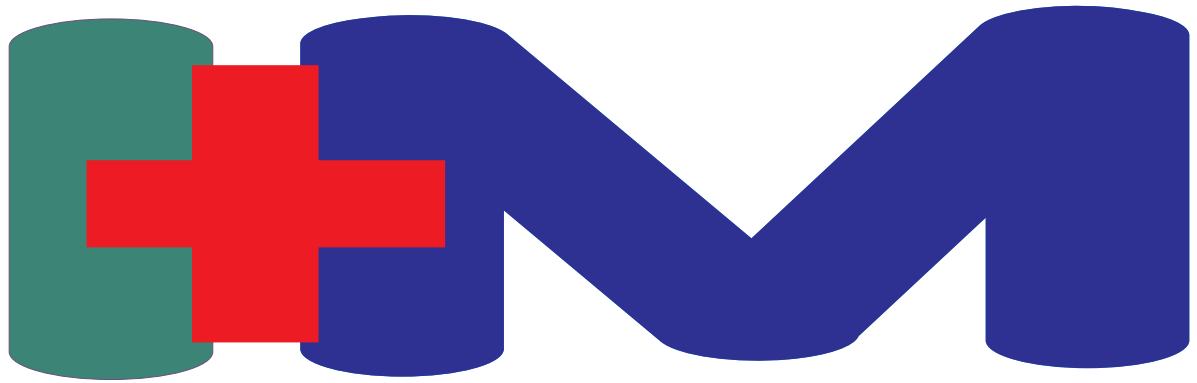

IBRAHIM MEDS

I N S T R U M E N T S

 77 A Model Town Ugoki Sialkot

 +92 52 3512235

 +92 52 4007564

 +92 300 7163508 , +92 307 6427547

 info@ibrahimmeds.com

 amjad@ibrahimmeds.com

 www.ibrahimmeds.com