

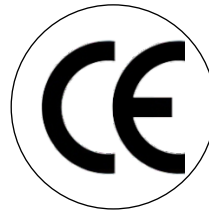

WE SERVE HUMANITY WITH EXCELLENCE

IBRAHIM MEDS



22- CRANIO MAXILLO FACIAL SURGERY

Cranio Maxillo Facial Surge



IM-23-501-16
Obwegeser
21.5cm 8 1/2"
Soft Tissue Retractor
5 x 16 mm
bent upwards

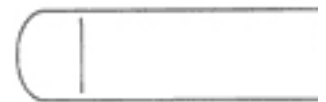

IM-23-501-50
bwegeser
23.5cm 9 1/4"
Soft Tissue Retractor
12 x 55 mm
bent upwards



IM-23-501-25
Obwegeser
22.5cm 8 3/4"
Soft Tissue Retractor
7 x 25 mm
bent upwards



IM-23-501-70
bwegeser
24cm 9 1/2"
Soft Tissue Retractor
14 x 70 mm
bent upwards

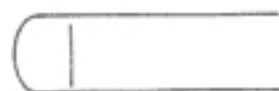

IM-23-501-35
Obwegeser
23cm 9"
Soft Tissue Retractor
10 x 35 mm
bent upwards



IM-23-501-80
Obwegeser
24cm 9 1/2"
Soft Tissue Retractor
16 x 80 mm
bent upwards



IM-23-501-42
Obwegeser
23cm 9"
Soft Tissue Retractor
10 x 42 mm
bent upwards

Cranio Maxillo Facial Surge



IM-23-505-16
Obwegeser
21.5cm 8 1/2"
Soft Tissue Retractor
5 x 16 mm
bent downwards

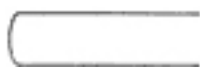

IM-23-505-25
Obwegeser
22.5cm 8 3/4"
Soft Tissue Retractor
7 x 25 mm
bent downwards



IM-23-505-.35
Obwegeser
23cm 9"
Soft Tissue Retractor
10 x 35 mm
bent downwards

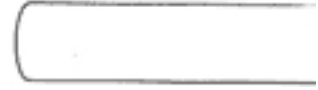

IM-23-505-42
Obwegeser
23cm 9"
10 x 42 mm
bent downwards
Soft Tissue Retractor



IM-23-505-55
Obwegeser
23.5cm 9 1/4"
Soft Tissue Retractor
12 x 55 mm
bent downwards

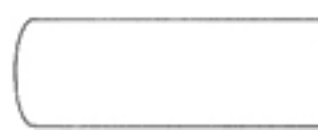

IM-23-505-70
Obwegeser
24cm 9 1/2"
Soft Tissue Retractor
14 x 70 mm
bent downwards



IM-23-505-80
Obwegeser
24cm 9 1/2"
Soft Tissue Retractor
16 x 80 mm
bent downwards

Cranio Maxillo Facial Surge



IM-23-510-30
Obwegeser
21cm 8 1/4"
Mandibular Retractor
9/12 x 30 mm

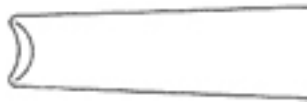

IM-23-510-45
Obwegeser
21cm 8 1/4"
Mandibular Retractor
9/12 x 45 mm

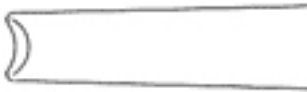

IM-23-510-60
Obwegeser
21cm 8 1/4"
Mandibular Retractor
9/12 x 60 mm

Cranio Maxillo Facial Surge

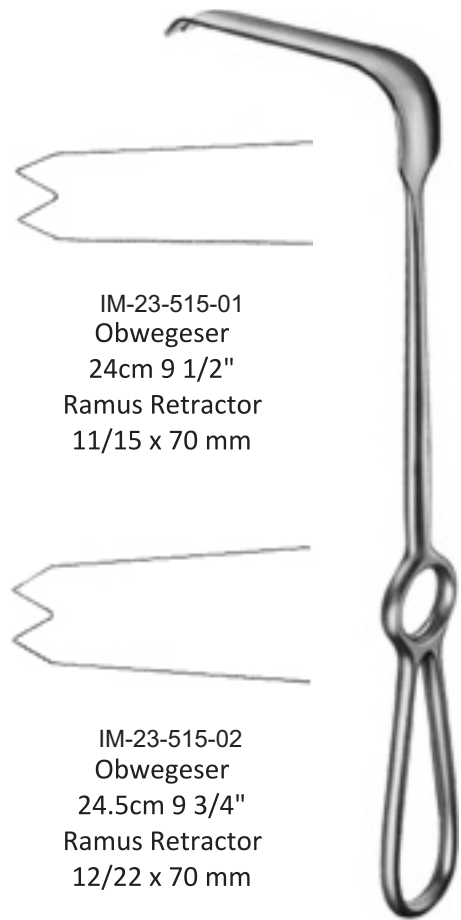

IM-23-515-01
Obwegeser
24cm 9 1/2"
Ramus Retractor
11/15 x 70 mm



IM-23-515-02
Obwegeser
24.5cm 9 3/4"
Ramus Retractor
12/22 x 70 mm

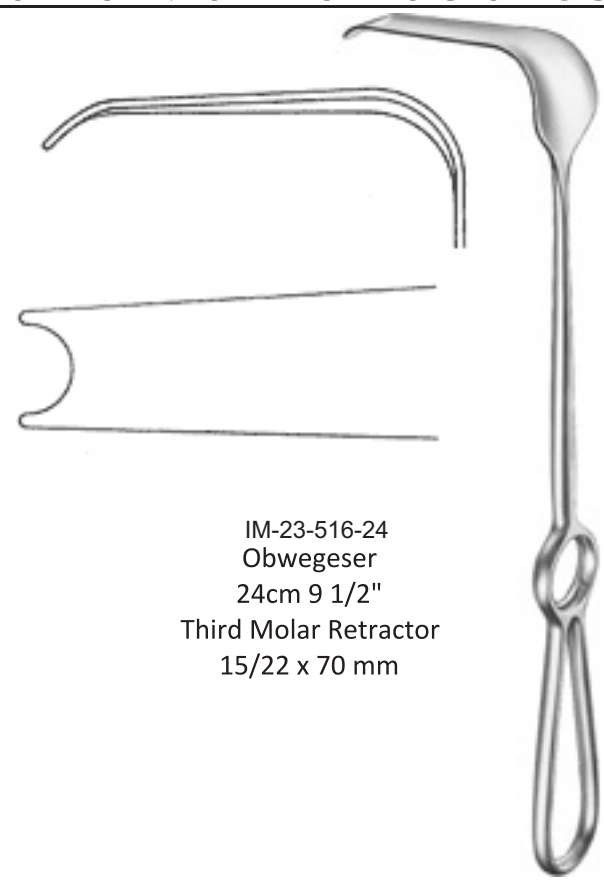

IM-23-516-24
Obwegeser
24cm 9 1/2"
Third Molar Retractor
15/22 x 70 mm

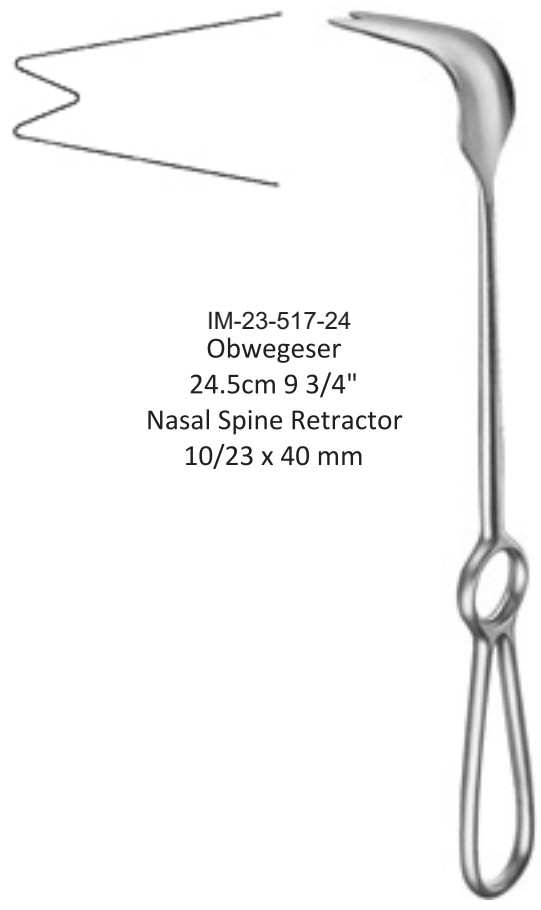

IM-23-517-24
Obwegeser
24.5cm 9 3/4"
Nasal Spine Retractor
10/23 x 40 mm

Cranio Maxillo Facial Surge



IM-23-520-01
Obwegeser
15cm 6"
Ramus Clamp
small pattern, right



IM-23-520-02
Obwegeser
15cm 6"
Ramus Clamp
small pattern, left



IM-23-522-01
Obwegeser
20cm 8"
Ramus Clamp
large pattern, right



IM-23-522-02
Obwegeser
20cm 8"
Ramus Clamp
large pattern, left

Cranio Maxillo Facial Surge



IM-23-520-01
Obwegeser
16.5cm 6 1/2"
Channel Retractor
8 mm

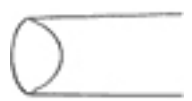

IM-23-520-02
Obwegeser
16.5cm 6 1/2"
Channel Retractor
10 mm

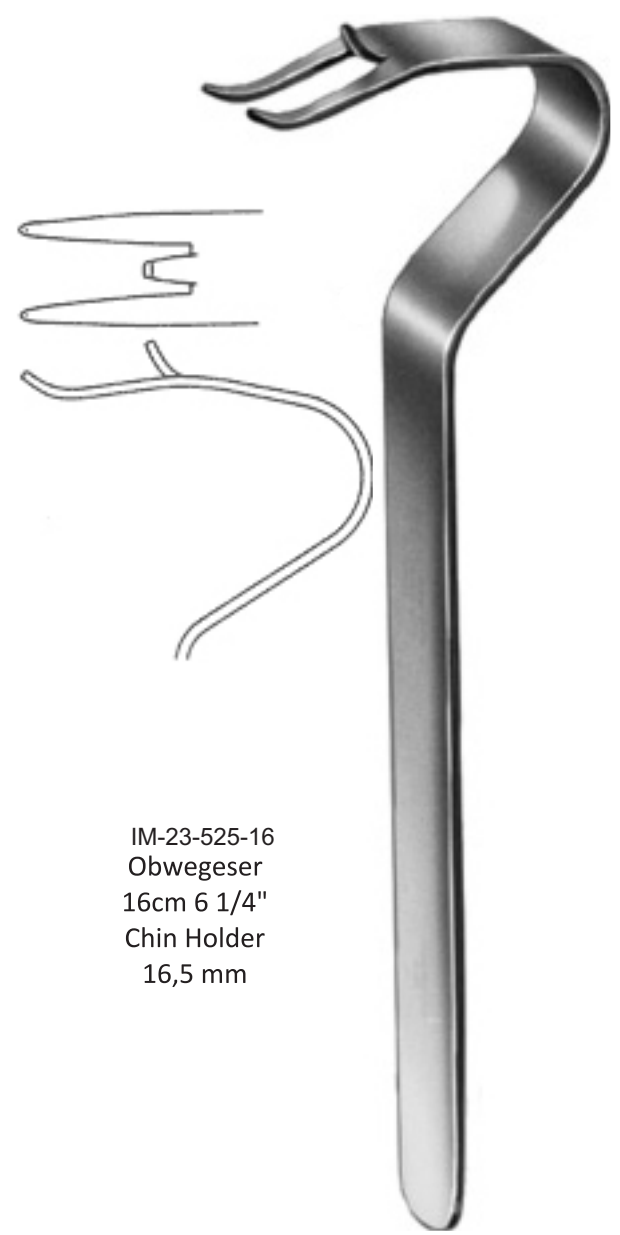

IM-23-525-16
Obwegeser
16cm 6 1/4"
Chin Holder
16,5 mm

Cranio Maxillo Facial Surge



IM-23-530-6
Obwegeser
18cm 7"
Periosteal Elevator
6 mm
angled cutting



IM-23-530-7
Obwegeser
18cm 7"
Periosteal Elevator
7 mm
angled cutting



IM-23-530-9
Obwegeser
18cm 7"
Periosteal Elevator
9 mm
angled cutting



IM-23-530-11
Obwegeser
18cm 7"
Periosteal Elevator
11 mm
angled cutting



IM-23-535-6
Obwegeser
18cm 7"
Periosteal Elevator
6 mm
flat cutting



IM-23-535-7
Obwegeser
18cm 7"
Periosteal Elevator
7 mm
flat cutting



IM-23-535-9
Obwegeser
18cm 7"
Periosteal Elevator
9 mm
flat cutting



IM-23-535-11
Obwegeser
18cm 7"
Periosteal Elevator
11 mm
flat cutting

Cranio Maxillo Facial Surge



IM-23-540-21
Obwegeser
21cm 8 1/4"
Elevator
6 mm Elevator



IM-23-542-21
Obwegeser
21cm 8 1/4"
Periosteal Elevator
6 mm Raspatory



IM-23-545-21
Obwegeser
18cm 7"
Mandibular Inferior
Border Raspatory
10 mm angled to left



IM-23-547-21
Obwegeser
18cm 7"
Mandibular Inferior
Border Raspatory
10 mm angled to right

Cranio Maxillo Facial Surge



IM-23-550-1
Obwegeser
17.5cm 7"
Swallowtail
Raspatory 7,5 mm

IM-23-550-2
Obwegeser
17.5cm 7"
Swallowtail
Raspatory 11 mm



IM-23-555-1
Obwegeser
20.5cm 8"
Ramus Periosteal
Elevator 5 mm



IM-23-555-2
Obwegeser
20.5cm 8"
Ramus Periosteal
Elevator 7 mm



IM-23-555-3
Obwegeser
20.5cm 8"
Ramus Periosteal
Elevator 9 mm



Cranio Maxillo Facial Surge



IM-23-560-4
Obwegeser
18.5cm 7 1/4"
Septonasal Osteotome
4 mm graduated

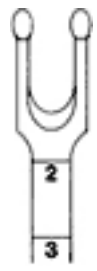

IM-23-560-6
Obwegeser
18.5cm 7 1/4"
Septonasal Osteotome
6 mm graduated

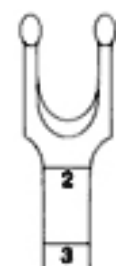

IM-23-560-8
Obwegeser
18.5cm 7 1/4"
Septonasal Osteotome
8 mm graduated



IM-23-562-8
Obwegeser
22cm 8 3/4"
Wedge Osteotome
8 mm



IM-23-562-12
Obwegeser
22cm 8 3/4"
Wedge Osteotome
12 mm



IM-23-562-16
Obwegeser
22cm 8 3/4"
Wedge Osteotome
16 mm



Cranio Maxillo Facial Surge



IM-23-565-8
Obwegeser
22cm 8 3/4"
Blade Osteotome
8 mm



IM-23-565-12
Obwegeser
22cm 8 3/4"
Blade Osteotome
12 mm



IM-23-565-20
Obwegeser
22cm 8 3/4"
Blade Osteotome
16 mm

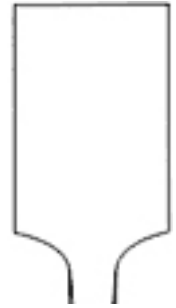

IM-23-565-16
Obwegeser
22cm 8 3/4"
Blade Osteotome
20 mm

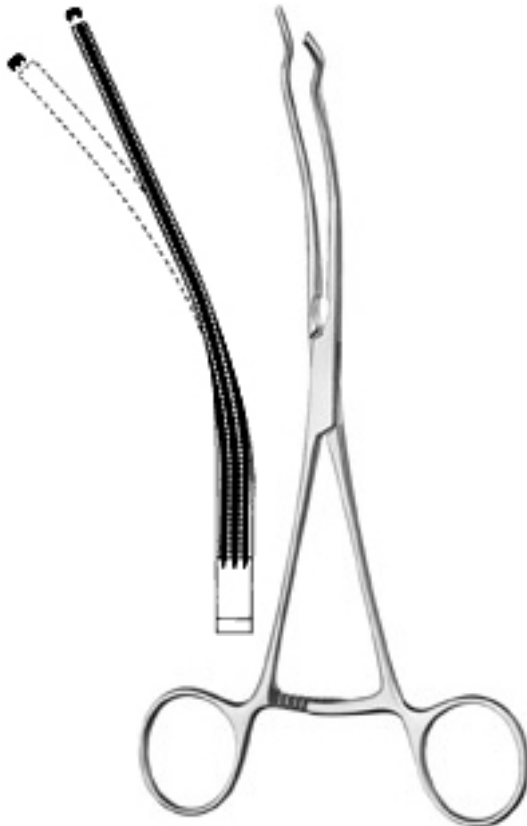

IM-23-570-L
Obwegeser
21cm 8 1/4"
Fragment Adapting Forceps
jaw length 80 mm left

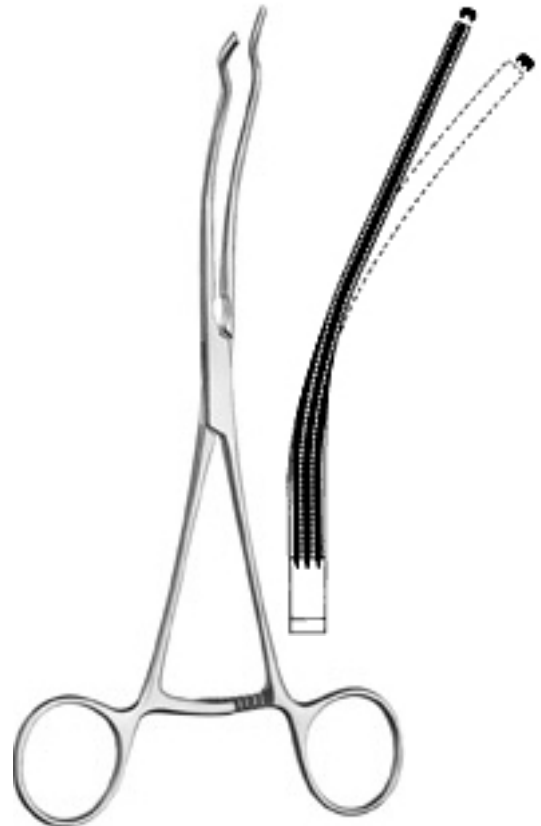

IM-23-570-R
Obwegeser
21cm 8 1/4"
Fragment Adapting Forceps
jaw length 80 mm right

Cranio Maxillo Facial Surge



IM-23-575-8
Obwegeser
23.5cm 9 1/4"
Tuberosity Osteotome
8 mm



IM-23-570-11
Obwegeser
23.5cm 9 1/4"
Tuberosity Osteotome
11 mm



IM-23-580-8
Obwegeser
21cm 8 1/4"
Osteotome
8 mm elastic blade



IM-23-580-11
Obwegeser
21cm 8 1/4"
Osteotome
11 mm elastic blade

Cranio Maxillo Facial Surge



IM-23-585-3
Obwegeser
15.5cm 6"
Osteotome for Alveolar
Process 3 mm



IM-23-585-4
Obwegeser
15.5cm 6"
Osteotome for Alveolar
Process 4 mm



IM-23-585-6
Obwegeser
15.5cm 6"
Osteotome for Alveolar
Process 6,5 mm

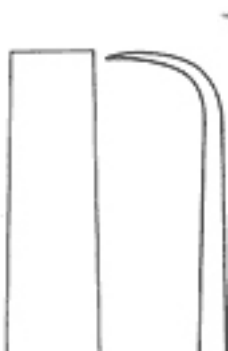

IM-23-590-23
Obwegeser
23cm 9"
Maxillary Mobilizer
12 mm



IM-23-595-01
Obwegeser
15cm 6"
Maxillary Awl



IM-23-595-02
Obwegeser
17.5cm 7"
Maxillary Awl



Cranio Maxillo Facial Surge



IM-23-600-24
Obwegeser
24cm 9 1/2"
Zygomatic Arch Awl



IM-23-605-11
Obwegeser
12cm 4 3/4"
Wire Cutter

Cranio Maxillo Facial Surge



IM-23-610-1
Obwegeser
17cm 6 3/4"
Bone Contouring
Forceps jaw
12 x 30 mm
convex / concave



IM-23-610-2
Obwegeser
17.5cm 7"
Bone Contouring
Forceps jaw
13,5 x 30 mm
concave / convex



IM-23-610-3
Obwegeser
17.5cm 7"
Bone Contouring
Forceps jaw
13,5 x 30 mm
flat / flat

Cranio Maxillo Facial Surge



IM-23-615-19
Tessier
19cm 7 1/2"
Skin Hooklet sharp

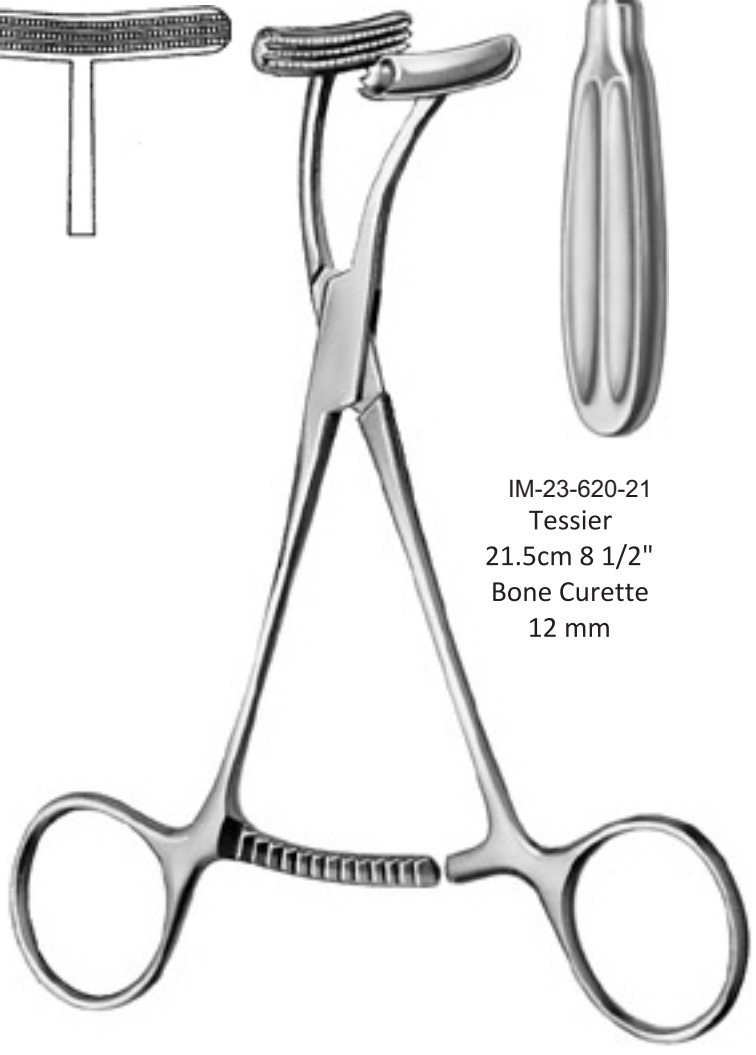
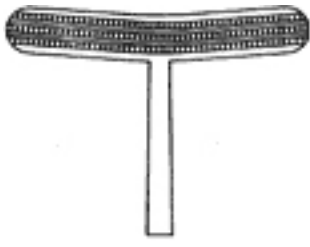

IM-23-625-13
Tessier
13cm 5"
Scalp Clamp



IM-23-620-21
Tessier
21.5cm 8 1/2"
Bone Curette
12 mm



IM-23-630-19
Tessier
19.5cm 7 3/4"
Curette Sharpener
Curette Sharpener

Cranio Maxillo Facial Surge



IM-23-640-30
Tessier
13.5cm 5 1/4"
Nasal Speculum
blades 36 mm
black chromium-plated

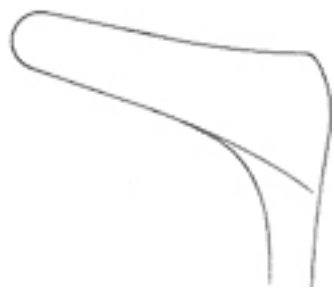

IM-23-640-45
Tessier
14cm 5 1/2"
Nasal Speculum
blades 45 mm
black chromium-plated

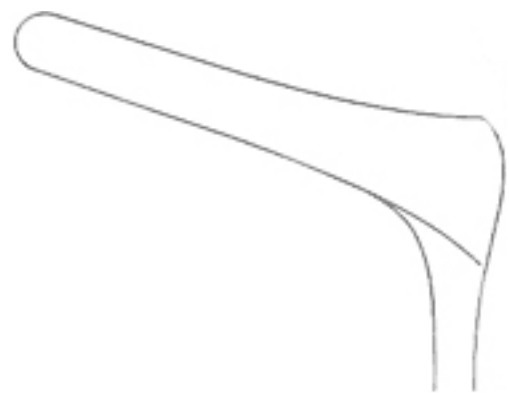

IM-23-640-70
Tessier
14.5cm 5 3/4"
Nasal Speculum
blades 70 mm
black chromium-plated



IM-23-635-22
Tessier
21.5cm 8 1/2"
Bone Curette 6 mm

Cranio Maxillo Facial Surge

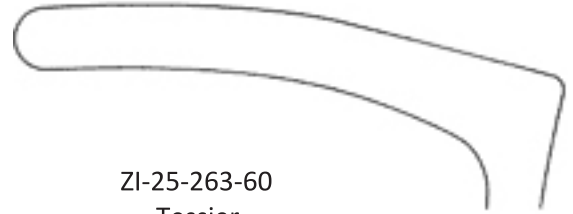

ZI-25-263-60
Tessier
17cm 6 3/4"
Nasal Speculum
blades 70 x 8,5 mm
for adults for dilation,
black chromi-um-plated

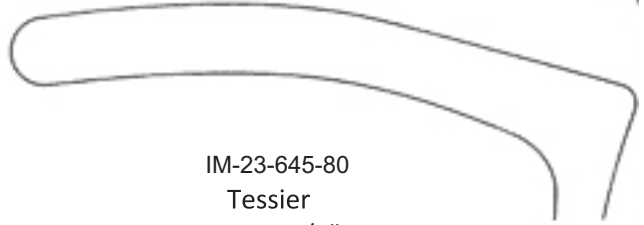

IM-23-645-80
Tessier
17cm 6 3/4"
Nasal Speculum
blades 80 x 8,5 mm
for adults for dilation,
black chromi-um-plated

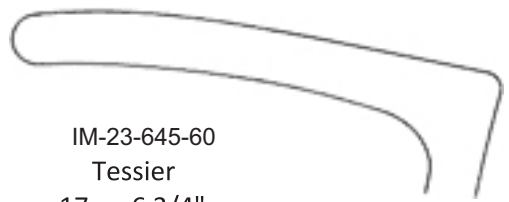



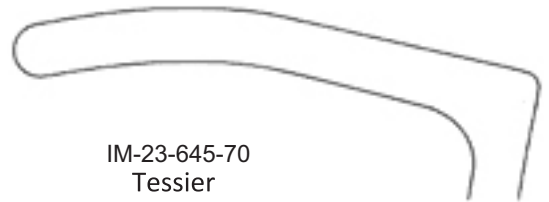



IM-23-645-60
Tessier
17cm 6 3/4"
Nasal Speculum
blades 60 x 7,0 mm
for children for dilation,
black chromi-um-plated



IM-23-645-70
Tessier
17cm 6 3/4"
Nasal Speculum
blades 70 x 7,0 mm
for children for dilation,
black chromi-um-plated

Cranio Maxillo Facial Surge



- | | | | | |
|---|---|---|---|---|
| 
IM-23-650-2
Tessier
16cm 6 1/4"
Osteotome
2 mm | 
IM-23-650-3
Tessier
16cm 6 1/4"
Osteotome
3 mm | 
IM-23-650-5
Tessier
16cm 6 1/4"
Osteotome
5 mm | 
IM-23-650-7
Tessier
16cm 6 1/4"
Osteotome
7 mm | 
IM-23-650-10
Tessier
16cm 6 1/4"
Osteotome
10 mm |
| 
IM-23-650-14
Tessier
16cm 6 1/4"
Osteotome
14 mm | 
IM-23-650-16
Tessier
16cm 6 1/4"
Osteotome
16 mm | | | |

Cranio Maxillo Facial Surge



IM-23-655-18
Tessier
16cm 6 1/4"
Osteotome
18 mm

IM-23-655-10
Tessier
18cm 7"
Osteotome
10 mm

Cranio Maxillo Facial Surge



IM-23-660-10
Tessier
20cm 7 3/4"
Osteotome
10 mm
for taking grafts
from ilium and tibia



IM-23-660-15
Tessier
20cm 7 3/4"
Osteotome
15 mm
for taking grafts
from ilium and tibia

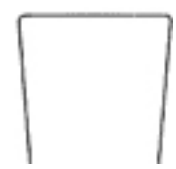

IM-23-660-20
Tessier
20cm 7 3/4"
Osteotome
20 mm
for taking grafts
from ilium and tibia



IM-23-660-30
Tessier
20cm 7 3/4"
Osteotome
30 mm
for taking grafts
from ilium and tibia

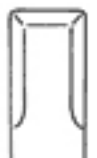

IM-23-665-10
Tessier
16cm 6 1/4"
Osteotome
10 mm
for taking grafts
from ilium and calva

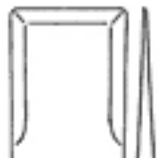

IM-23-665-15
Tessier
16cm 6 1/4"
Osteotome
15 mm
for taking grafts
from ilium and calva



IM-23-665-20
Tessier
16cm 6 1/4"
Osteotome
10 mm
for taking grafts
from the calva

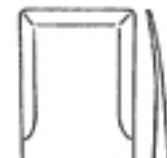

IM-23-665-30
Tessier
16cm 6 1/4"
Osteotome
15 mm
for taking grafts
from the calva



Cranio Maxillo Facial Surge



IM-23-670-22
Tessier
20.5cm 8"
Thoracic Retractor
90 x 22 mm
black chromium-plated

IM-23-670-28
Tessier
28cm 11"
Thoracic Retractor
120 x 28 mm
black chromium-plated

IM-23-675-1
Tessier
16cm 6 1/4"
Iliac Crest Retractor
36 x 50 mm black
chromium-plated

IM-23-675-2
Tessier
16cm 6 1/4"
Iliac Crest Retractor
52 x 50 mm black
chromium-plated

IM-23-675-3
Tessier
16cm 6 1/4"
Iliac Crest Retractor
59 x 50 mm black
chromium-plated

IM-23-675-4
Tessier
16cm 6 1/4"
Iliac Crest Retractor
66 x 50 mm black
chromium-plated

Cranio Maxillo Facial Surge



IM-23-680-16
Tessier
16.5cm 6 1/2"
Bone Holding Forceps
5 mm



IM-23-680-18
Tessier
18cm 7"
Bone Holding Forceps
5 mm

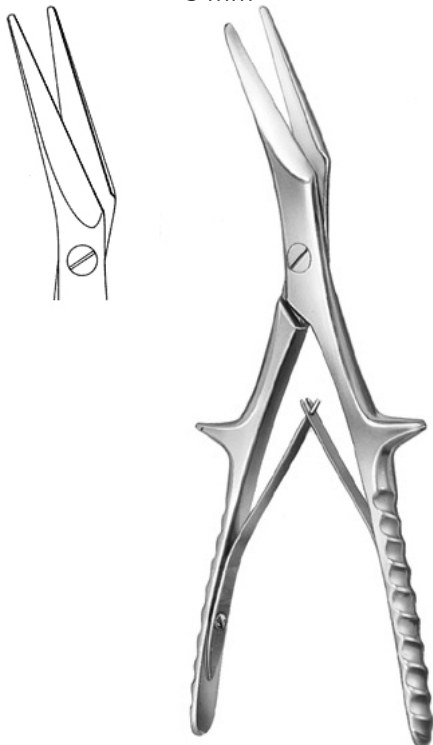

IM-23-680-19
Tessier
19.5cm 7 3/4"
Bone Cutting Forceps
1 serrated cutting edge



IM-23-682-19
Tessier
19cm 7 1/2"
Bone Cutting Forceps
1 serrated cutting edge

Cranio Maxillo Facial Surge



IM-23-685-20
Tessier
20.5cm 8"
Bone Cutting Forceps
slim pattern



IM-23-685-21
Tessier
21.5cm 8 1/2"
Bone Cutting Forceps

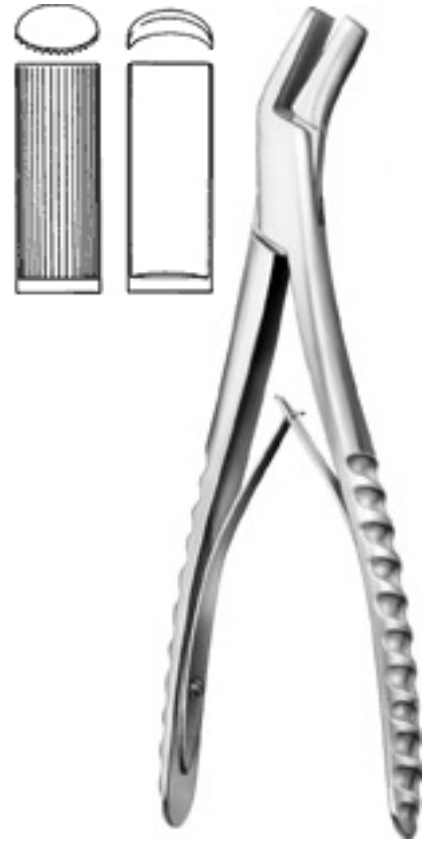

IM-23-685-22
Tessier
22cm 8 3/4"
Bone Contouring
Forceps
11 mm
convex / concave
Bone Contouring Forceps

Cranio Maxillo Facial Surge



IM-23-690-1
Tessier
20.5cm 8"
Iliac Crest Awl



IM-23-690-2
Tessier
21cm 8 1/4"
Iliac Crest Awl



IM-23-690-3
Tessier
21.5cm 8 1/2"
Iliac Crest Awl

Cranio Maxillo Facial Surge



IM-23-700-1
Tessier
18.5cm 7 1/4"
Periosteal Elevator
6 mm30°



IM-23-700-2
Tessier
18cm 7"
Periosteal Elevator
6 mm60°



IM-23-695-1
Tessier
20.5cm 8"
Periosteal Elevator
12 mm



IM-23-695-2
Tessier
20.5cm 8"
Periosteal Elevator
15 mm



Cranio Maxillo Facial Surge



IM-23-705-21
Tessier
21cm 8 1/4"
Awl
2,5 mm Ø



IM-23-705-16
Tessier
16.5cm 6 1/2"
Awl
4,5 mm Ø



IM-23-705-14
Tessier
14cm 5 1/2"
Trocar
2,5 mm Ø
Trocar

Cranio Maxillo Facial Surge



IM-23-710-1
Tessier
22cm 8 3/4"
Spatula
10 - 12 mm
conical black
chromium-plated



IM-23-710-2
Tessier
22cm 8 3/4"
Spatula
15 - 17 mm
conical black
chromium-plated



IM-23-710-3
Tessier
22cm 8 3/4"
Spatula
20 - 22 mm
conical black
chromium-plated

Cranio Maxillo Facial Surge



IM-23-715-1
Tessier
15cm 6"
Soft Tissue Retractor
20 x 7 / 30 x 10 mm
black chromium-plated



IM-23-715-2
Tessier
15cm 6"
Soft Tissue Retractor
20 x 12 / 30 x 16 mm
black chromium-plated

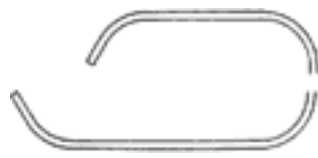

IM-23-715-3
Tessier
15.5cm 6"
Soft Tissue Retractor
30 x 12 / 35 x 16 mm
black chromium-plated



IM-23-715-4
Tessier
15.5cm 6"
Soft Tissue Retractor
35 x 12 / 45 x 16 mm
black chromium-plated



Cranio Maxillo Facial Surge



IM-23-715-1
Tessier
14.5cm 5 3/4"
Soft Tissue Retractor
30 x 12 / 35 x 16 mm
black chromium-plated



IM-23-715-2
Tessier
15cm 6"
Soft Tissue Retractor
35 x 12 / 45 x 16 mm
black chromium-plated

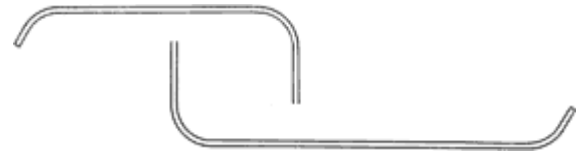

IM-23-715-3
Tessier
16cm 6 1/4"
Soft Tissue Retractor
50 x 12 / 70 x 16 mm
black chromium-plated



IM-23-715-4
Tessier
15.5cm 6"
Soft Tissue Retractor
50 x 12 / 70 x 16 mm
black chromium-plated

Cranio Maxillo Facial Surge



IM-23-720-1
Tessier
12.5cm 5"
Soft Tissue Retractor
Fig. 1 8 mm
black chromium-plated



IM-23-720-2
Tessier
12.5cm 5"
Soft Tissue Retractor
Fig. 210 mm
black chromium-plated



IM-23-720-3
Tessier
12.5cm 5"
Soft Tissue Retractor
Fig. 37 mm
black chromium-plated



IM-23-720-4
Tessier
12.5cm 5"
Soft Tissue Retractor
Fig. 410 mm
black chromium-plated



IM-23-720-5
Tessier
12.5cm 5"
Soft Tissue Retractor
Fig. 58 mm
black chromium-plated



IM-23-720-6
Tessier
12.5cm 5"
Soft Tissue Retractor
Fig. 612 mm
black chromium-plated

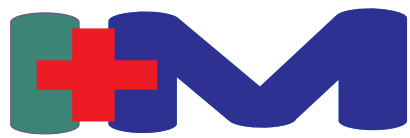

Cranio Maxillo Facial Surge



IM-23-725-10
Tessier
14.5cm 5 3/4"
Saddle Hooklet
10 mm
black chromium-plated



IM-23-725-17
Tessier
15cm 6"
Saddle Hooklet
17,5 mm
black chromium-plated



IM-23-725-20
Tessier
15.5cm 6"
Saddle Hooklet
20 mm
black chromium-plated



IM-23-730-18
Tessier
18.5cm 7 1/4"
Septonasal Osteotome
Septonasal Osteotome



IM-23-735-18
Tessier
18cm 7"
Osteotome
10 mm



IM-23-740-16
Tessier
16.5cm 6 1/2"
Retromaxillary Chisel
6 mm
Retromaxillary Chisel



IM-23-745-16
Tessier
16.5cm 6 1/2"
Retromaxillary Chisel
9 mm
Retromaxillary Chisels

Cranio Maxillo Facial Surge

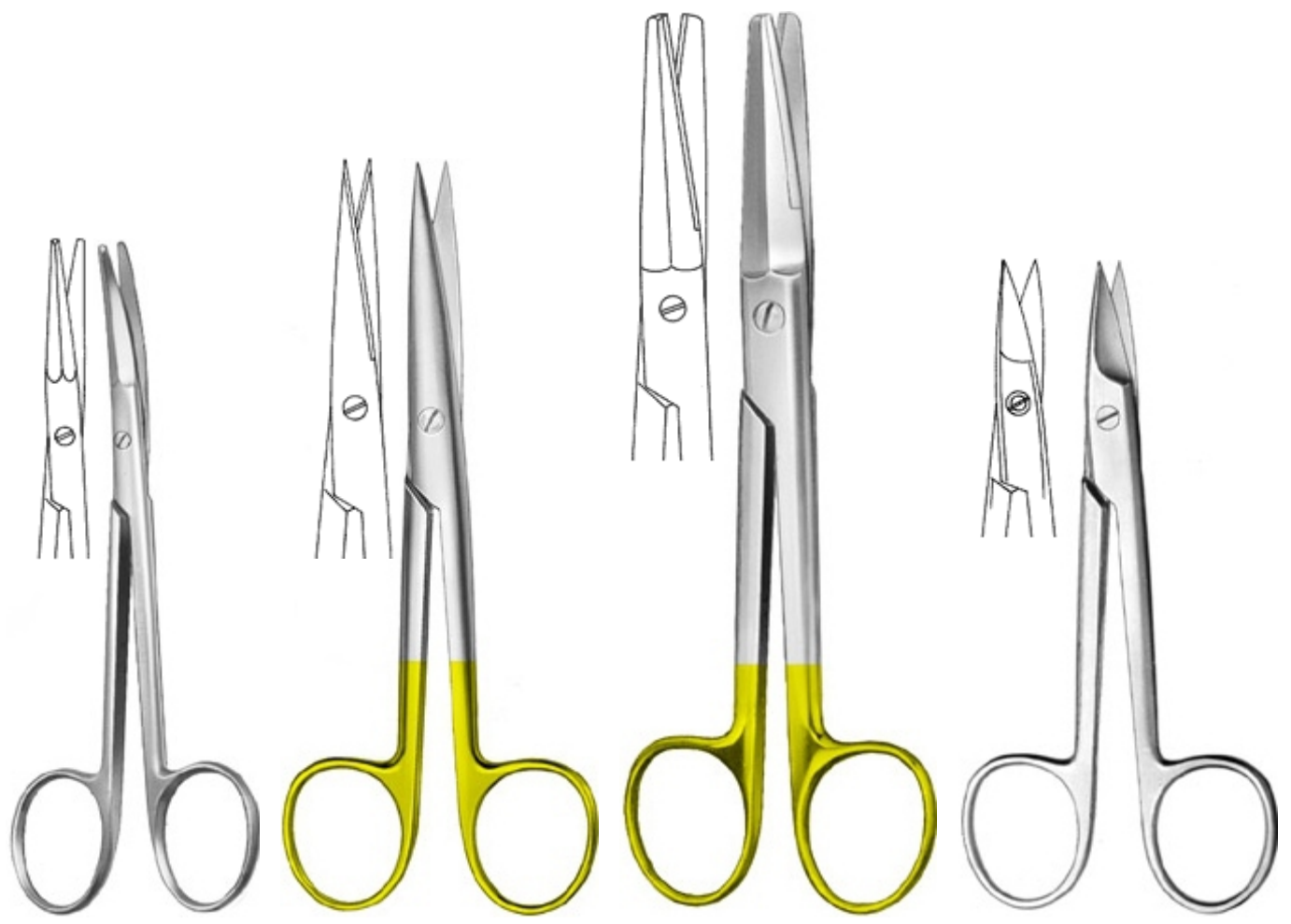

IM-23-750-13
Tessier
13cm 5"
Undermining Scissors
Undermining Scissors

IM-23-750-14
Tessier
14.5cm 5 3/4"
Dissecting Scissors

IM-23-750-16
Tessier
16.5cm 6 1/2"
Dissecting Scissors

IM-23-752-16
Tessier
12cm 4 3/4"
Wire Cutting Scissors

Cranio Maxillo Facial Surge

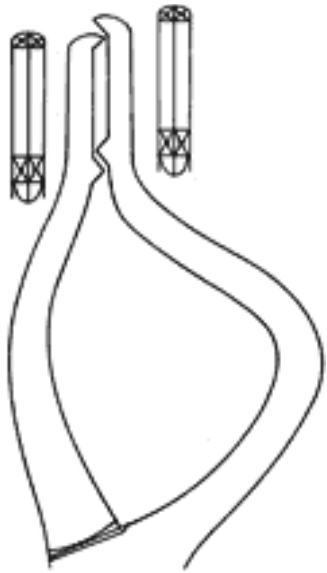

IM-23-755-1
Tessier
22cm 8 3/4"
Disimpaction Forceps
left for children

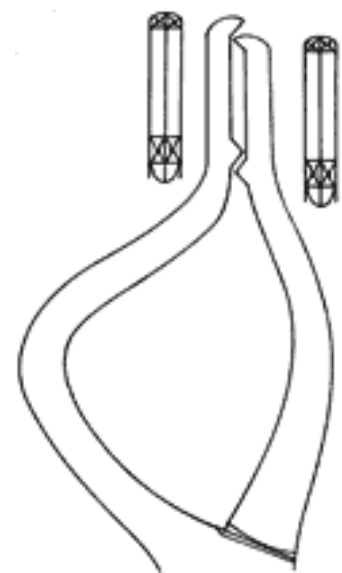

IM-23-755-2
Tessier
22cm 8 3/4"
Disimpaction Forceps
right for children

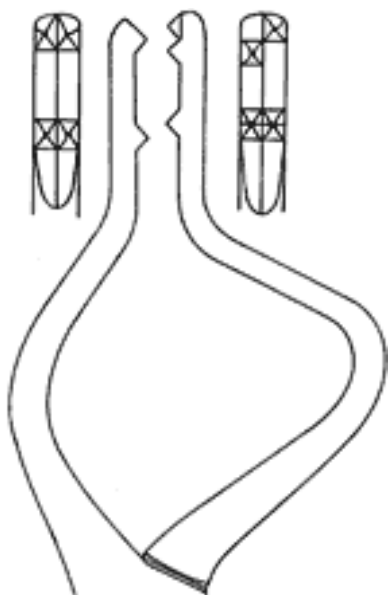

IM-23-757-1
Tessier
23cm 9"
Disimpaction Forceps
left for adults

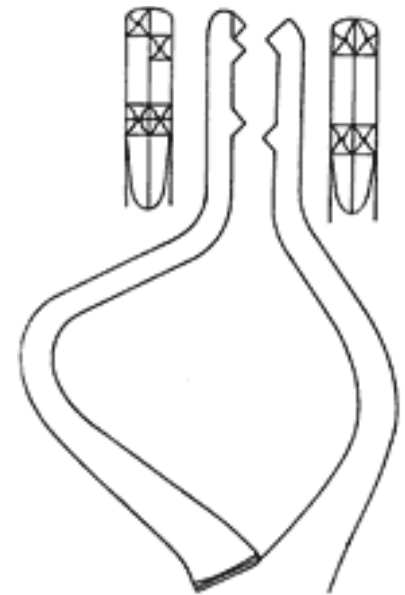

IM-23-757-2
Tessier
23cm 9"
Disimpaction Forceps
right for adults

Cranio Maxillo Facial Surge

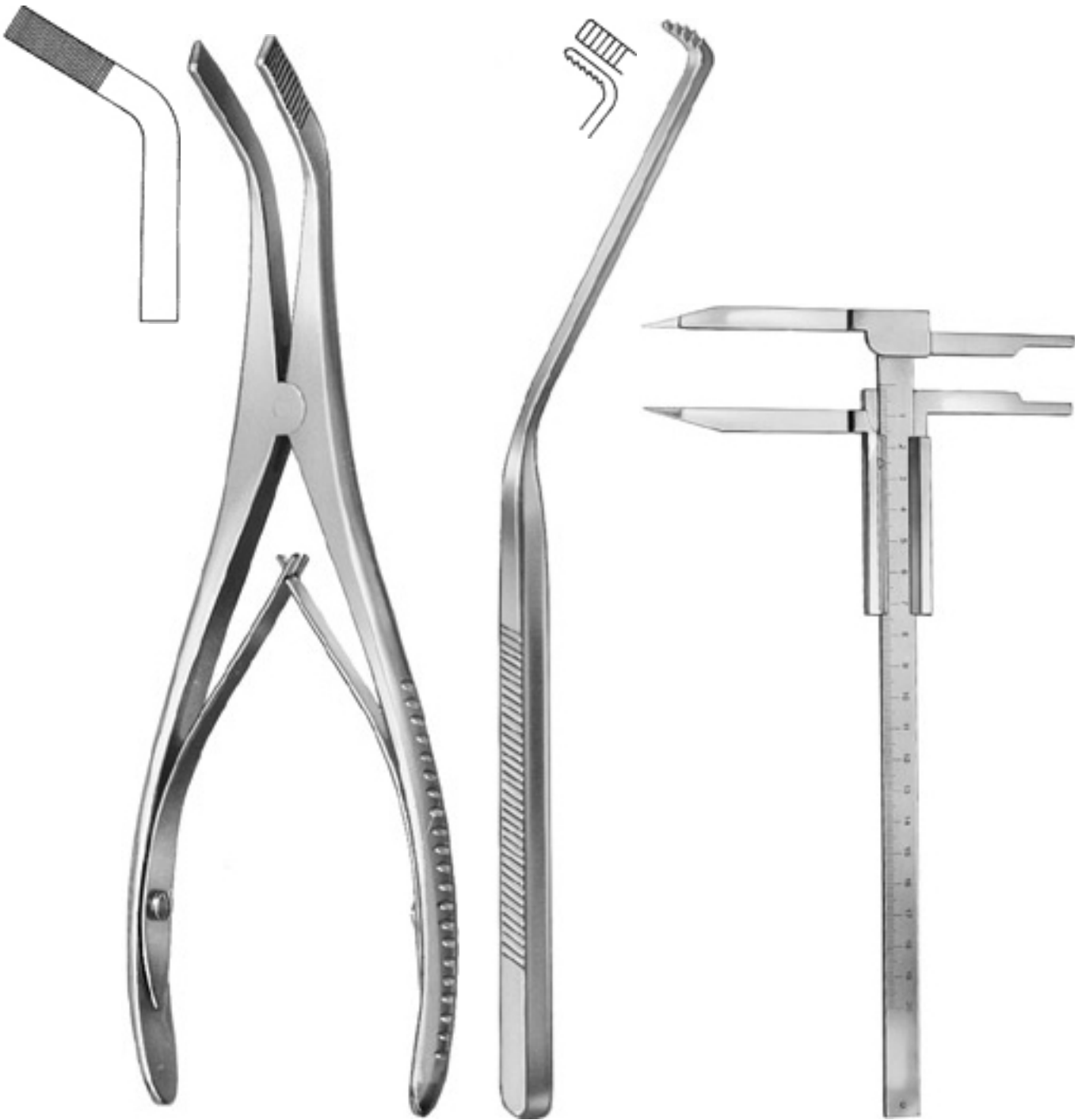

IM-23-760-18
Tessier
17.5cm 7"
Spreading Forceps
7 mm
Spreading Forceps

IM-23-765-18
Tessier
18.5cm 7 1/4"
Bone Hook
black chromium-plated

IM-23-770-26
Tessier
26cm 10 1/4"
Caliper measuring
range up to 200 mm

Cranio Maxillo Facial Surge



IM-23-775-1
Tessier
15cm 6"
Mobilizing Retractor
9 mm
right

IM-23-775-2
Tessier
15cm 6"
Mobilizing Retractor
9 mm
left

Cranio Maxillo Facial Surge



IM-23-780-7
Marchac
15.5cm 6"
Periosteal Elevator
7,5 mm



IM-23-780-12
Marchac
15.5cm 6"
Periosteal Elevator
12 mm



IM-23-780-2
Marchac
17cm 6 3/4"
Periosteal
Elevator
2 mm



IM-23-780-3
Marchac
17cm 6 3/4"
Periosteal
Elevator
3,5 mm

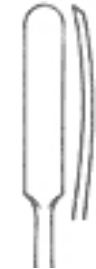

IM-23-780-5
Marchac
17cm 6 3/4"
Periosteal
Elevator
5 mm



Cranio Maxillo Facial Surge



IM-23-785-0
Marchac
Frontal Template
for infants
Frontal Templates



IM-23-785-1
Marchac
Frontal Template
for children and adults
Frontal Templates



IM-23-790-16
Marchac
16cm 6 1/4"
Supraorbital Template
1,9 mm Ø
Supraorbital Template



IM-23-795-18
Marchac
18cm 7"
Dura Protector graduated

Cranio Maxillo Facial Surge



IM-23-800-80
Marchac
Caliper measuring range
80 mm

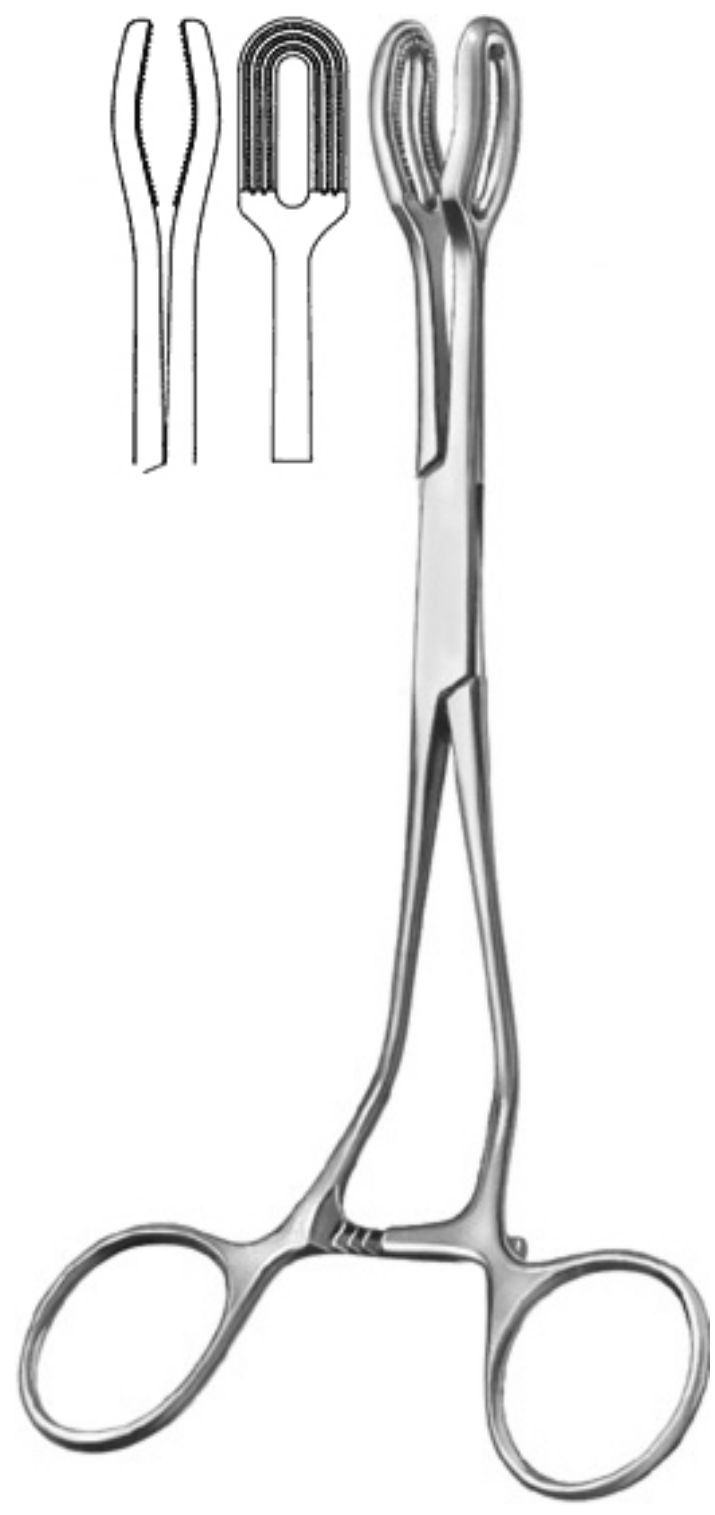
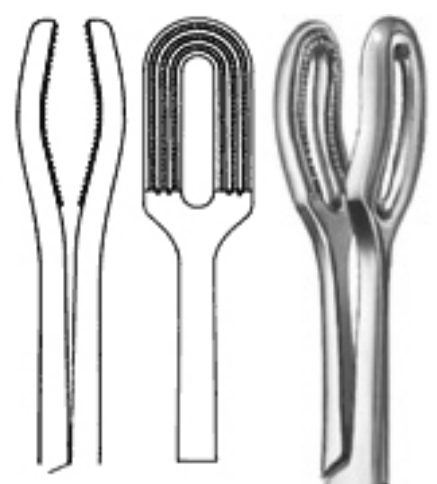

IM-23-805-17
Marchac
17cm 6 3/4"
Bone Holding Forceps angled

Cranio Maxillo Facial Surge



IM-23-810-4
Marchac
18.5cm 7 1/4"
Osteotome 4 mm



IM-23-810-6
Marchac
18.5cm 7 1/4"
Osteotome 6 mm



IM-23-810-8
Marchac
18.5cm 7 1/4"
Osteotome 8 mm



IM-23-812-6
Marchac
18.5cm 7 1/4"
Osteotome
6 mm curved



IM-23-805-19
Marchac
19cm 7 1/2"
Suction Dissector

Cranio Maxillo Facial Surge



IM-23-815-19
Marchac
19cm 7 1/2"
Bone Hook sharp



IM-23-820-17
Marchac
17cm 6 3/4"
Bone Expander
Spreading Forceps



IM-23-820-18
Marchac
18cm 7"
Cranial Rongeur

Cranio Maxillo Facial Surge

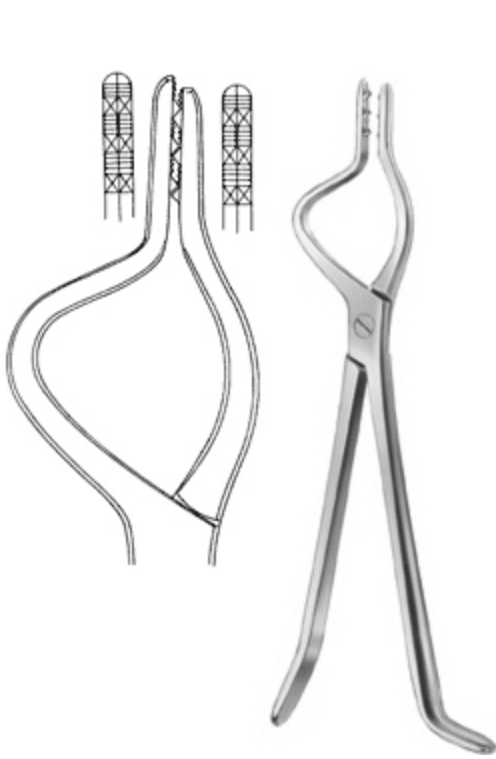

IM-23-825-23
Marchac
23cm 9"
Disimpaction Forceps
for children



IM-23-830-1
Marchac
18cm 7"
Bone Contouring Forceps
convex / concave
for children 6,5 mm



IM-23-830-2
Marchac
18cm 7"
Bone Contouring Forceps
convex / concave for children
11 mm



IM-23-835-21
Marchac
21.5cm 8 1/2"
Dura Protector / Wire Catcher

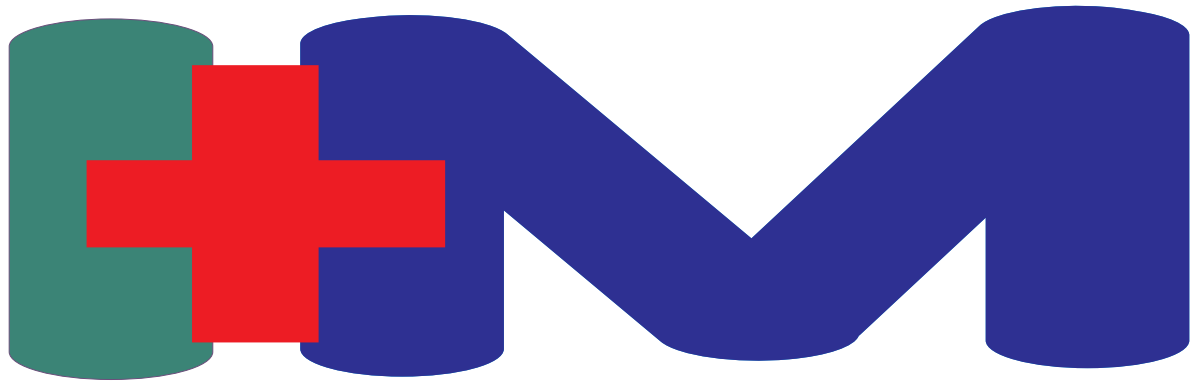

IBRAHIM MEDS

I N S T R U M E N T S

 77 A Model Town Ugoki Sialkot

 +92 52 3512235

 +92 52 4007564

 +92 300 7163508 , +92 307 6427547

 info@ibrahimmeds.com

 amjad@ibrahimmeds.com

 www.ibrahimmeds.com