

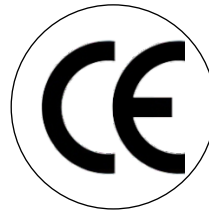

**WE SERVE HUMANITY WITH EXCELLENCE**











# **IBRAHIM MEDS**



## **3-FORCEPS**

## Forceps











					
IM-03-100-10	IM-03-100-11	IM-03-100-13	IM-03-100-14	IM-03-100-16	
4"	4 1/2"	5"	5 3/4"	6 1/4"	
					
IM-03-100-18	IM-03-100-20	IM-03-100-23	IM-03-100-25	IM-03-100-16	
7"	8"	9"	9 3/4"	12"	

Dressing Forceps  
standard pattern

# Forceps



Dressing Forceps  
standard pattern

					
IM-03-105-11	IM-03-105-13	IM-03-105-14	IM-03-105-16	IM-03-105-18	
4 3/4"	5"	5 3/4"	6 1/4"	7"	
					
IM-03-105-20	IM-03-105-25	IM-03-105-30			
8"	9 3/4"	11 3/4"			

Forceps



Dressing Forceps  
IM-03-110-13  
5"  
standard pattern



Dressing Forceps  
IM-03-110-14  
5 3/4"  
standard pattern



Dressing Forceps  
IM-03-110-15  
6"  
standard pattern

Forceps



Mini-Adson Dressing Forceps  
IM-03-115-12  
4 3/4"



Adson Dressing Forceps  
IM-03-116-12  
4 3/4"



Adson Dressing Forceps  
IM-03-115-15  
6"

## Forceps



McIndoe Dressing Forceps  
IM-03-120-15  
6"



Waugh Dressing Forceps  
IM-03-125-20  
8"



Semken Dressing Forceps  
IM-03-130-12  
5"



Semken Dressing Forceps  
IM-03-130-15  
6"

Forceps



Taylor Dressing Forceps  
IM-03-135-16  
6 3/4"



Taylor Dressing Forceps  
IM-03-137-16  
6 3/4"  
with dissector end



Taylor Dressing Forceps  
IM-03-137-18  
7 1/4"  
with dissector end

## Forceps

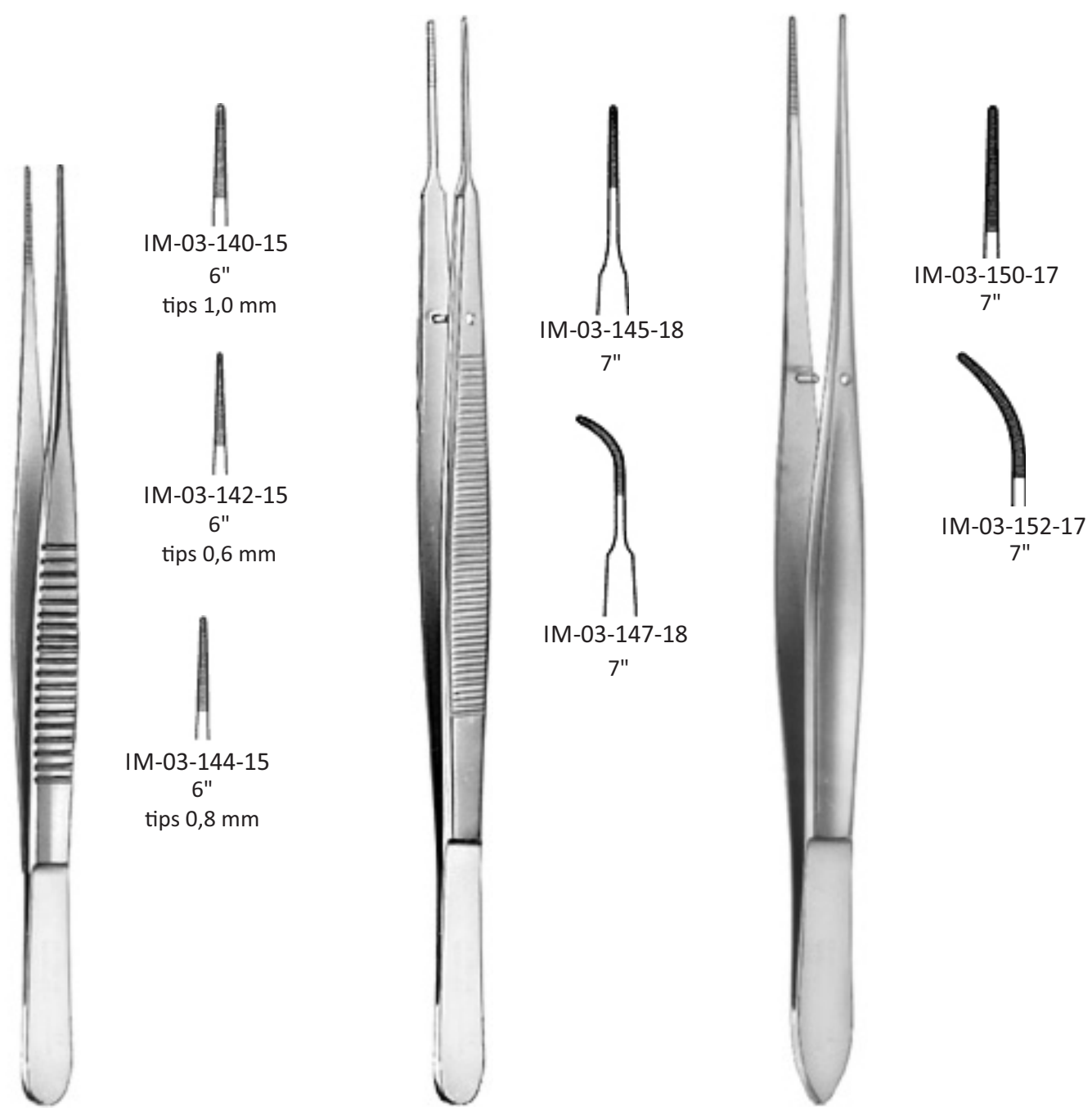

Micro Dressing Forceps

Gerald Dressing Forceps

Cushing Dressing Forceps

## Forceps

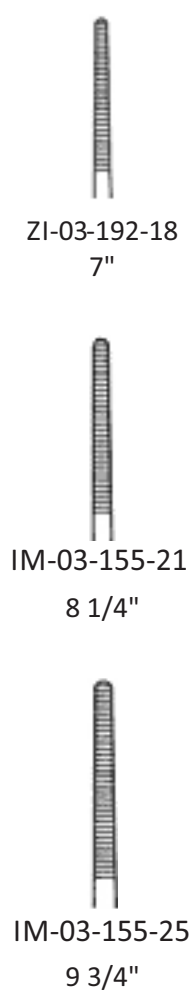

Potts-Smith Dressing Forceps

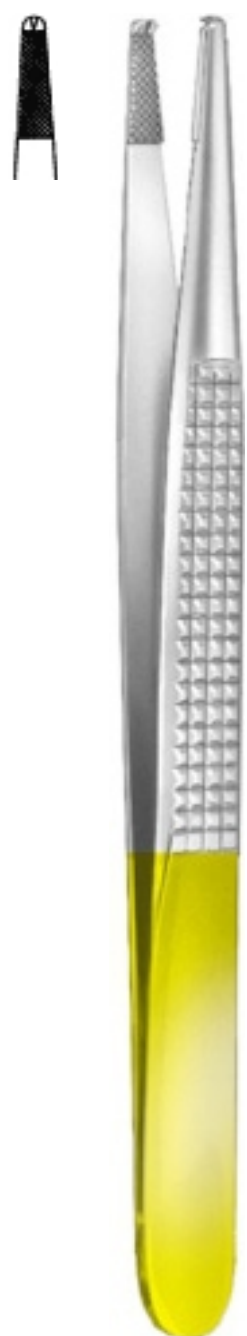

Bonney Dissecting Forceps  
IM-03-160-17 TC  
7"  
1:2 teeth normal profile



Gerald Dissecting Forceps  
IM-03-170-17 TC  
7"  
1:2 teeth mini profile

# Forceps



Gillies Dissecting Forceps  
IM-03-180-15 TC  
6"  
1:2 teeth  
mini profile



McIndoe Dressing Forceps  
IM-03-190-15 TC  
6"  
mini profile



Semken Dissecting Forceps



IM-03-195-15 TC  
6"  
normal profile  
1:2 teeth



IM-03-197-15 TC  
6"  
mini profile  
1:2 teeth



IM-03-197-18 TC  
7"  
normal profile  
1:2 teeth



IM-03-199-15 TC  
6"  
mini profile  
1:2 teeth

## Forceps

- |                          |                        |                          |                        |
|--------------------------|------------------------|--------------------------|------------------------|
|                          |                        |                          |                        |
| IM-03-200-15 TC<br>6"    | IM-03-205-16 TC<br>6"  | IM-03-205-18 TC<br>7"    | IM-03-207-15 TC<br>6"  |
| normal profile 1:2 teeth | mini profile 1:2 teeth | normal profile 1:2 teeth | mini profile 1:2 teeth |



Semken Dissecting Forceps

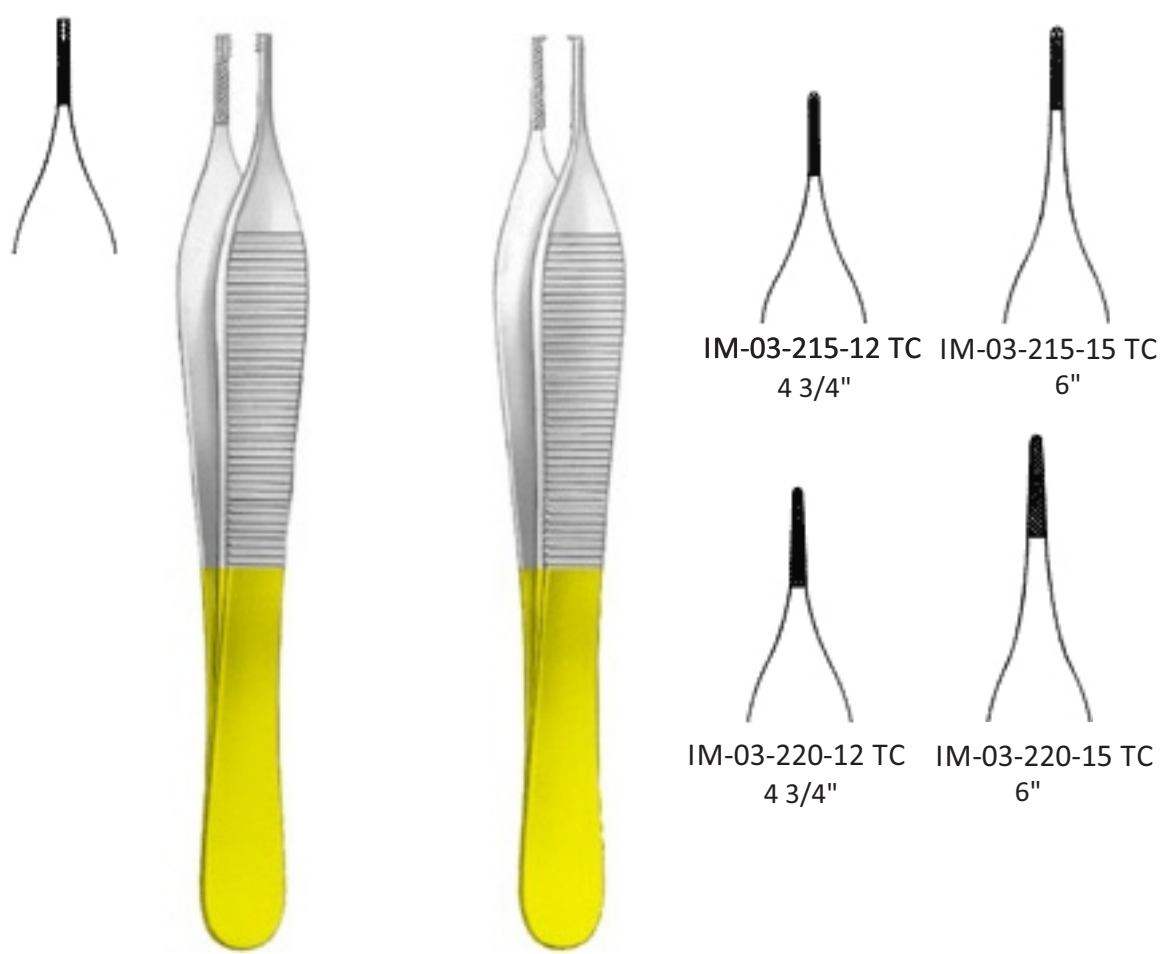

Adson-Brown Dissecting Forceps IM-03-210-12 TC 4 3/4" normal profile	Adson Dissecting Forceps
---	--------------------------

- |                           |                       |
|---------------------------|-----------------------|
|                           |                       |
| IM-03-215-12 TC<br>4 3/4" | IM-03-215-15 TC<br>6" |
|                           |                       |
| IM-03-220-12 TC<br>4 3/4" | IM-03-220-15 TC<br>6" |

Forceps



Adson Dissecting Forceps  
IM-03-225-12  
4 3/4"  
normal profile 1:2 teeth

Adson Dissecting Forceps  
IM-03-225-15  
6"  
normal profile 1:2 teeth

Forceps



Cushing Dressing Forceps  
IM-03-230-18 TC  
7"  
normal profile

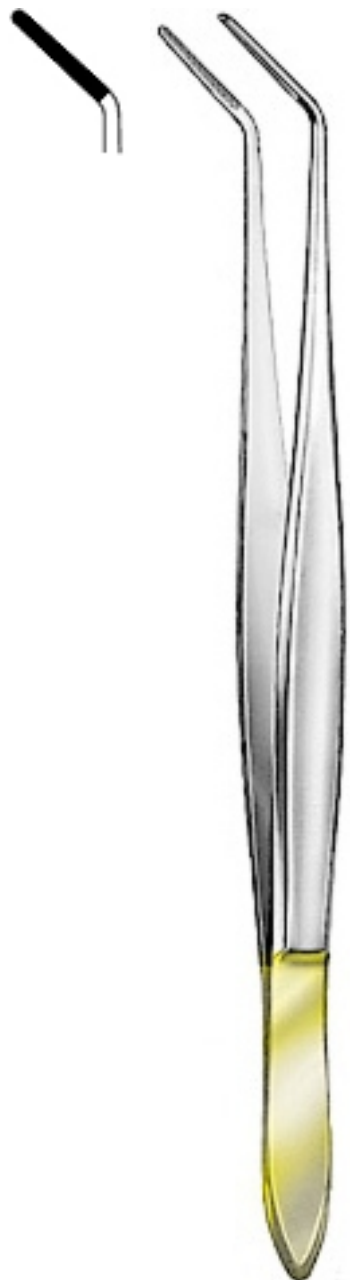

Cushing Dressing Forceps  
IM-03-230-17 TC  
6 3/4"  
normal profile



Cushing-Taylor Dressing Forceps  
IM-03-230-19 TC  
7 1/4"  
normal profile

# Forceps



IM-03-235-16 TC  
6 1/4"

IM-03-235-18 TC  
7 1/4"

IM-03-235-20 TC  
8"

IM-03-235-23 TC  
9"

IM-03-235-25 TC  
9 3/4"

Potts-Smith Dressing Forceps



IM-03-240-14 TC  
5 3/4"

IM-03-240-24 TC  
9 3/4"

IM-03-240-16 TC  
6 1/4"

IM-03-240-17 TC  
7"

IM-03-240-20 TC  
8"

Oehler Dissecting Forceps

## Forceps



IM-03-242-15 TC  
6"



IM-03-242-23 TC  
9"



Wangensteen Dressing Forceps



IM-03-245-16 TC  
6 1/4"  
micro profile 1,6 mm



IM-03-245-20 TC  
8"  
micro profile 1,6 mm



IM-03-245-24 TC  
9 3/4"  
micro profile 1,6 mm



IM-03-247-16 TC  
6 1/4"  
mini profile 2,0 mm



IM-03-247-20 TC  
8"  
mini profile 2,0 mm



IM-03-247-24 TC  
9 3/4"  
mini profile 2,0 mm

DeBakey Atraumatic Dressing  
Forceps

## Forceps



DeBakey Atraumatic  
Dressing Forceps



IM-03-250-16  
6 1/4"  
jaw 1,5 mm



IM-03-250-20  
8"  
jaw 1,5 mm



IM-03-250-24  
9 1/2"  
jaw 1,5 mm



IM-03-252-16  
6 1/4"  
jaw 1,8 mm







IM-03-252-20  
8"  
jaw 1,8 mm

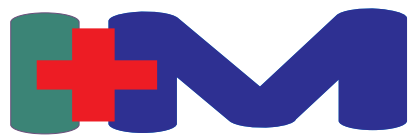

IM-03-252-24  
9 1/2"  
jaw 1,8 mm







## Forceps

-   
 IM-03-255-10  
 4"  
 1:2 teeth
-   
 IM-03-255-11  
 4 1/2"  
 1:2 teeth
-   
 IM-03-255-13  
 5"  
 1:2 teeth
-   
 IM-03-255-14  
 5 3/4"  
 1:2 teeth
-   
 IM-03-255-16  
 6 1/4"  
 1:2 teeth

-   
 IM-03-255-18  
 7"  
 1:2 teeth
-   
 IM-03-255-20  
 8"  
 1:2 teeth
-   
 IM-03-255-23  
 9"  
 1:2 teeth
-   
 IM-03-255-25  
 9 3/4"  
 1:2 teeth
-   
 IM-03-255-30  
 12"  
 1:2 teeth



Dissecting Forceps

-   
 IM-03-260-11  
 4 3/4"  
 2:3 teeth
-   
 IM-03-260-13  
 5"  
 2:3 teeth
-   
 IM-03-260-14  
 5 3/4"  
 2:3 teeth
-   
 IM-03-260-16  
 6"  
 2:3 teeth

-   
 IM-03-260-18  
 7"  
 2:3 teeth
-   
 IM-03-260-20  
 8"  
 2:3 teeth
-   
 IM-03-260-25  
 9 3/4"  
 2:3 teeth



Dissecting Forceps

## Forceps



- IM-03-265-14  
5 3/4"  
3:4 teeth
- IM-03-265-16  
6 1/4"  
3:4 teeth



- IM-03-270-14  
5 3/4"  
4:5 teeth
- IM-03-270-16  
6 1/4"  
4:5 teeth

Dissecting Forceps

Dissecting Forceps

## Forceps



Dissecting Forceps



IM-03-275-13  
5"  
1:2 teeth  
slender pattern



IM-03-275-14  
5 3/4"  
1:2 teeth  
slender pattern



IM-03-275-16  
6 1/4"  
1:2 teeth  
slender pattern

IM-03-275-20



IM-03-275-20  
8"  
1:2 teeth  
slender pattern

Forceps

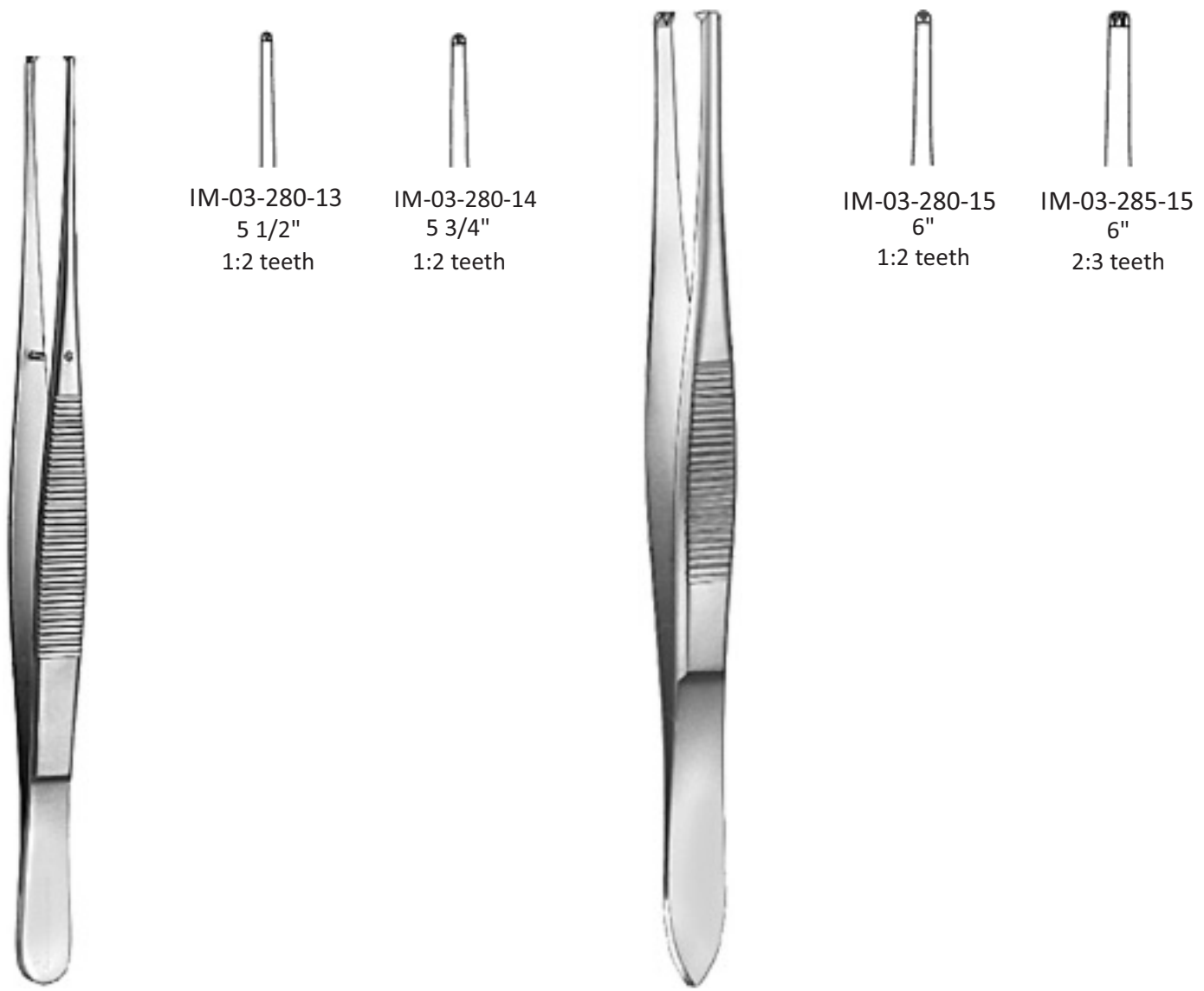

Dissecting Forceps

Forceps



Stone Dissecting Forceps  
IM-03-290-15  
6"  
4:5 teeth



Lerche Dissecting Forceps  
IM-03-295-15  
6"  
5:6 teeth

# Forceps



Adlerkreutz Dissecting Forceps

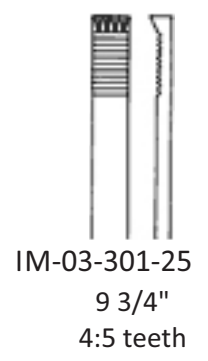
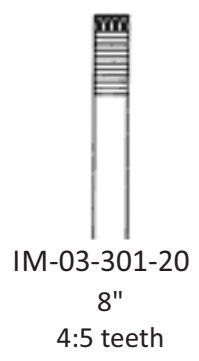
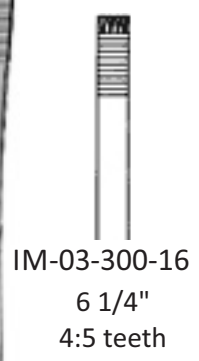
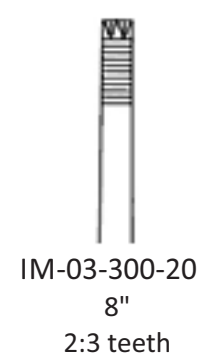
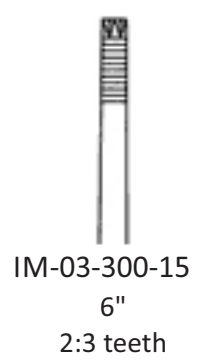

Forceps



Adson Dissecting Forceps

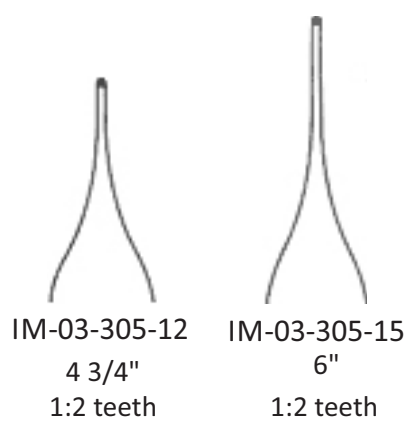

IM-03-305-12  
4 3/4"  
1:2 teeth

IM-03-305-15  
6"  
1:2 teeth



Gillies Dissecting Forceps  
IM-03-310-15  
6"  
1:2 teeth



Waugh Dissecting Forceps  
IM-03-315-20  
8"  
1:2 teeth

## Forceps



Semken Dissecting Forceps

IM-03-320-12  
5"  
1:2 teeth

6"  
1:2 teeth



Taylor Dissecting Forceps

IM-03-325-17  
7"  
1:2 teeth

IM-03-325-16  
6 3/4"  
1:2 teeth



Taylor Dissecting Forceps  
IM-03-330-17  
7 1/4"  
1:2 teeth

## Forceps

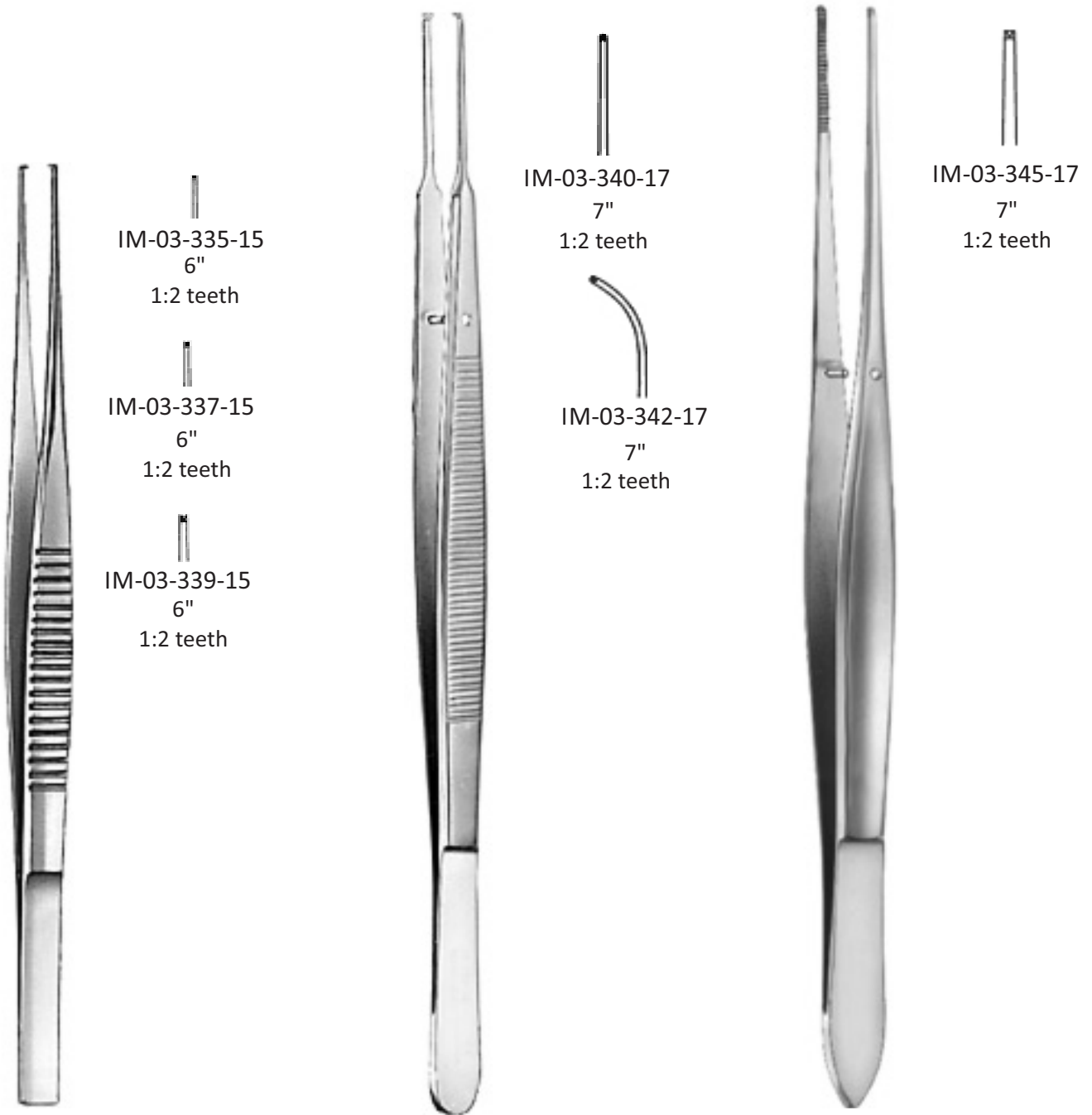

Micro Dissecting Forceps

Gerald Dissecting Forceps

Cushing Dissecting Forceps

## Forceps



Adson Dissecting Forceps  
IM-03-350-13  
5"



Mini-Adson Dissecting Forceps  
IM-03-350-12  
4 3/4"  
1:2 teeth



Mini-Adson Dissecting Forceps  
IM-03-352-12  
4 3/4"  
1:2 teeth

## Forceps



Mikro-Adson Dressing Forceps

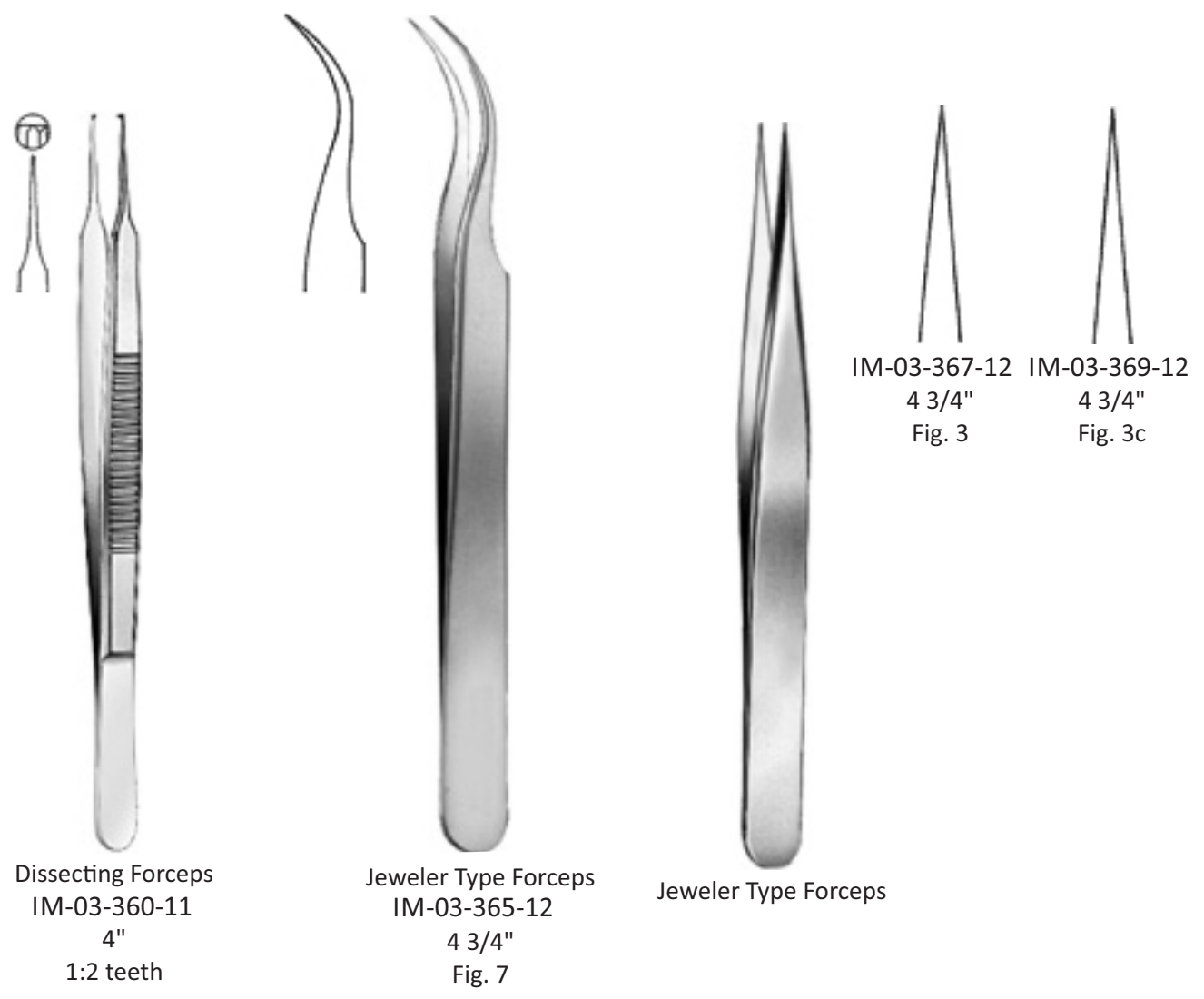

IM-03-369-12

## Forceps



Jeweler Type Forceps  
IM-03-370-11  
4 1/4"  
Fig. 5



Jeweler Type Forceps  
IM-03-372-11  
4 1/4"  
Fig. 4



IM-03-375-15  
6"



IM-03-375-20  
8"



IM-03-375-25  
10"

Russ. Pattern Dissecting Forceps

## Forceps

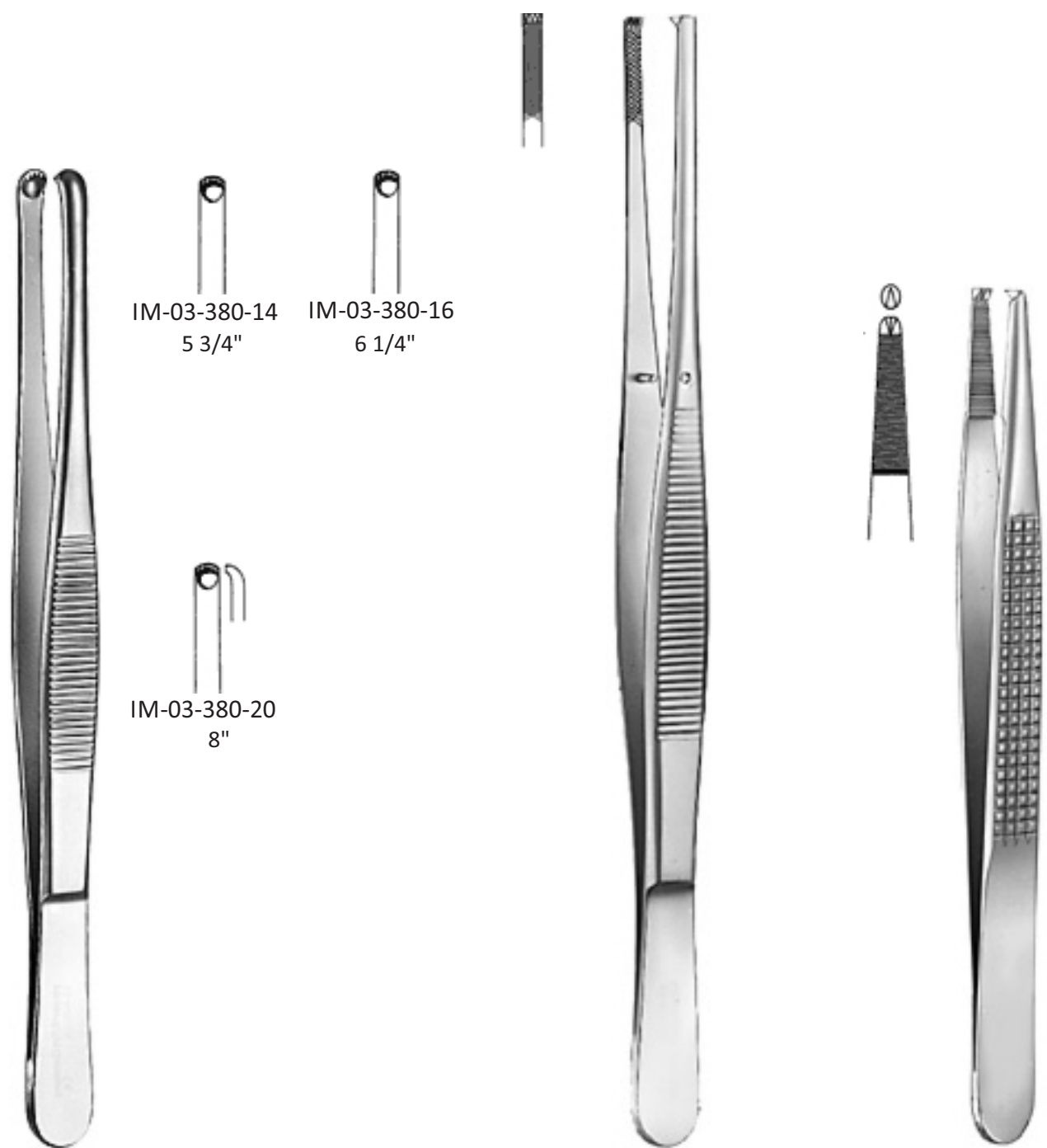

IM-03-380-14  
5 3/4"

IM-03-380-16  
6 1/4"

IM-03-380-20  
8"

Durante Dissecting Forceps

Stille-Barraya Dissecting Forceps  
IM-03-385-18  
7"

Bonney Dissecting Forceps  
IM-03-390-18  
7"  
1:2 teeth

Forceps



Mayo Dissecting Forceps  
IM-03-400-23  
9"



Singley-Tuttle Dissecting Forceps  
IM-03-405-18  
7"



Singley-Tuttle Dissecting Forceps  
IM-03-407-23  
9"

## Forceps



Dressing Forceps  
delicate

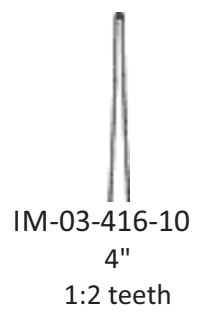

Forceps



Splinter Forceps  
IM-03-425-12  
5"  
smooth jaw



Splinter Forceps  
IM-03-427-12  
5"  
smooth jaw

Forceps



Splinter Forceps  
IM-03-430-12  
5"  
smooth jaw



Splinter Forceps  
IM-03-432-12  
5"  
smooth jaw

## Forceps



Splinter Forceps  
Feilchenfeld

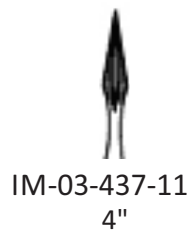

Splinter Forceps  
Hunter

Forceps



Cilia Forceps  
IM-03-440-09  
3 1/2"



Cilia Forceps  
IM-03-442-09  
3 1/2"



Cilia Forceps  
IM-03-442-10  
4"

Forceps



Bulldog Clamp  
Johns-Hopkins



IM-03-445-05  
2"



IM-03-445-06  
2 1/4"



IM-03-445-08  
2 3/4"

## Forceps



Bulldog Clamp



Diethrich  
IM-03-450-08  
3.5  
jaw length 8 mm  
closingpressure 50  
gr.weight 3 gr.



Diethrich  
IM-03-450-10  
4.55  
jaw length 12 mm  
closingpressure 50  
gr.weight 3 gr.



Diethrich  
IM-03-450-12  
5  
jaw length 20 mm  
closingpressure 50  
gr.weight 3 gr.



Diethrich  
IM-03-452-08  
4.5  
jaw length 8 mm  
closingpressure 50  
gr.weight 3 gr.



Diethrich  
IM-03-452-10  
5  
jaw length 12 mm  
closingpressure 50  
gr.weight 3 gr.



Diethrich  
IM-03-452-12  
6  
jaw length 20 mm  
closingpressure 50  
gr.weight 3 gr.



DeBakey-Diethrich  
IM-03-454-10  
4.5  
jaw length 10 mm  
closingpressure 180  
gr.weight 3 gr.



DeBakey-Diethrich  
IM-03-454-14  
5  
jaw length 10 mm  
closingpressure 180  
gr.weight 3 gr.



DeBakey-Diethrich  
IM-03-454-20  
6  
jaw length 10 mm  
closingpressure 180  
gr.weight 3 gr.



DeBakey-Diethrich  
IM-03-456-10  
3.5  
jaw length 10 mm  
closingpressure 180  
gr.weight 3 gr.



DeBakey-Diethrich  
IM-03-456-14  
4.5  
jaw length 10 mm  
closingpressure 180  
gr.weight 3 gr.



DeBakey-Diethrich  
IM-03-456-20  
6  
jaw length 10 mm  
closingpressure 180  
gr.weight 3 gr.

## Forceps



Bulldog Clamp  
IM-03-460-30  
30  
jaw length 9 mm  
closing pressure 110 +/- 10 gr.weight 1 gr.



Bulldog Clamp  
IM-03-460-35  
35  
jaw length 13 mm  
closing pressure 110 +/- 10 grweight 1 gr



Bulldog Clamp  
IM-03-460-40  
40  
jaw length 14 mm  
closing pressure 110 +/- 10 gr.weight 1 gr.



Bulldog Clamp  
IM-03-460-50  
50  
jaw length 23 mm  
closing pressure 110 +/- 10 gr.weight 1,5 gr.

## Forceps



Bulldog Clamp  
IM-03-465-30  
30  
jaw length 10 mm  
closing pressure 110 +/- 10 gr.  
weight 1 gr.



Bulldog Clamp  
IM-03-465-35  
35  
jaw length 14 mm  
closing pressure 110 +/- 10 gr.  
weight 1 gr.



Bulldog Clamp  
IM-03-465-40  
40  
jaw length 15 mm  
closing pressure 110 +/- 10 gr.  
weight 1 gr.



Bulldog Clamp  
IM-03-465-50  
50  
jaw length 21 mm  
closing pressure 110 +/- 10 gr.  
weight 1,5 gr.

Forceps



Bulldog Clamp  
IM-03-470-30  
30  
jaw length 9 mm  
closing pressure 220 +/-  
10 gr.weight 1 gr.



Bulldog Clamp  
IM-03-470-35  
35  
jaw length 13 mm  
closing pressure 220 +/-  
10 gr.weight 1 gr.



Bulldog Clamp  
IM-03-470-40  
40  
jaw length 14 mm  
closing pressure 220 +/-  
10 gr.weight 1 gr.



Bulldog Clamp  
IM-03-470-50  
50  
jaw length 23 mm  
closing pressure 220 +/-  
10 gr.weight 1,5 gr.

## Forceps



Bulldog Clamp  
IM-03-475-30  
30  
jaw length 9 mm  
closing pressure 220 +/-  
10 gr.weight 1 gr.



Bulldog Clamp  
IM-03-475-35  
35  
jaw length 13 mm  
closing pressure 220 +/-  
10 gr.weight 1 gr.



Bulldog Clamp  
IM-03-475-40  
40  
jaw length 14 mm  
closing pressure 220 +/-  
10 gr.weight 1 gr.



Bulldog Clamp  
IM-03-475-50  
50  
jaw length 22 mm  
closing pressure 220 +/-  
10 gr.weight 1,5 gr.

## Forceps



Bulldog Clamp  
IM-03-480-30  
30  
jaw length 10 mm  
closing pressure 220 +/-  
10 gr.weight 1 gr.



Bulldog Clamp  
IM-03-480-35  
35  
jaw length 14 mm  
closing pressure 220 +/-  
10 gr.weight 1 gr.



Bulldog Clamp  
IM-03-480-40  
40  
jaw length 15 mm  
closing pressure 220 +/-  
10 gr.weight 1 gr.



Bulldog Clamp  
IM-03-480-50  
50  
jaw length 21 mm  
closing pressure 220 +/-  
10 gr.weight 1,5 gr.

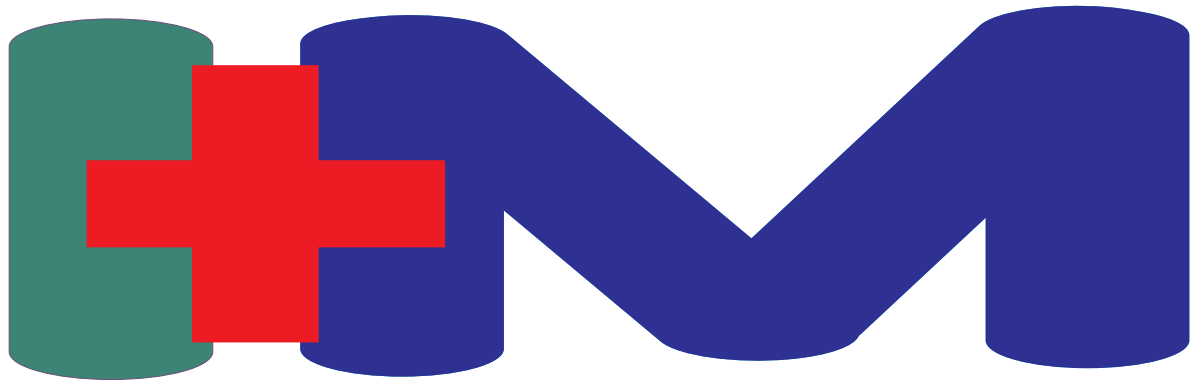

# IBRAHIM MEDS

---

I N S T R U M E N T S

 77 A Model Town Ugoki Sialkot

 +92 52 3512235

 +92 52 4007564

 +92 300 7163508 , +92 307 6427547

 info@ibrahimmeds.com

 amjad@ibrahimmeds.com

 www.ibrahimmeds.com