

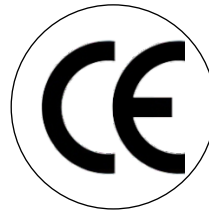

WE SERVE HUMANITY WITH EXCELLENCE

IBRAHIM MEDS



3-FORCEPS

Forceps



IM-03-500-13
5 1/2"



IM-03-502-13
5 1/4"



Splinter Forceps
Peet
IM-03-505-11
5"



Forceps



Splinter Forceps
IM-03-510-15
6"



Splinter Forceps
IM-03-512-15
6"

Forceps



Haemostatic Forceps
Pean



IM-03-515-14
5 3/4"



IM-03-515-16
6 1/4"

Forceps

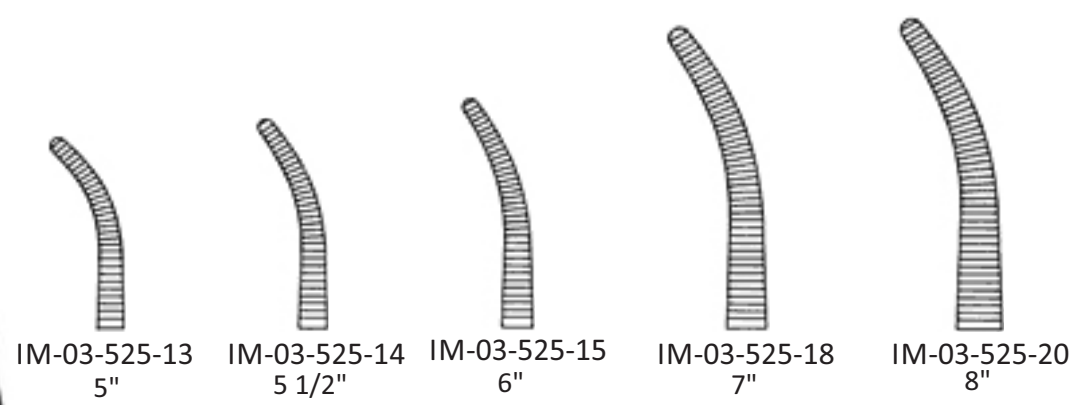
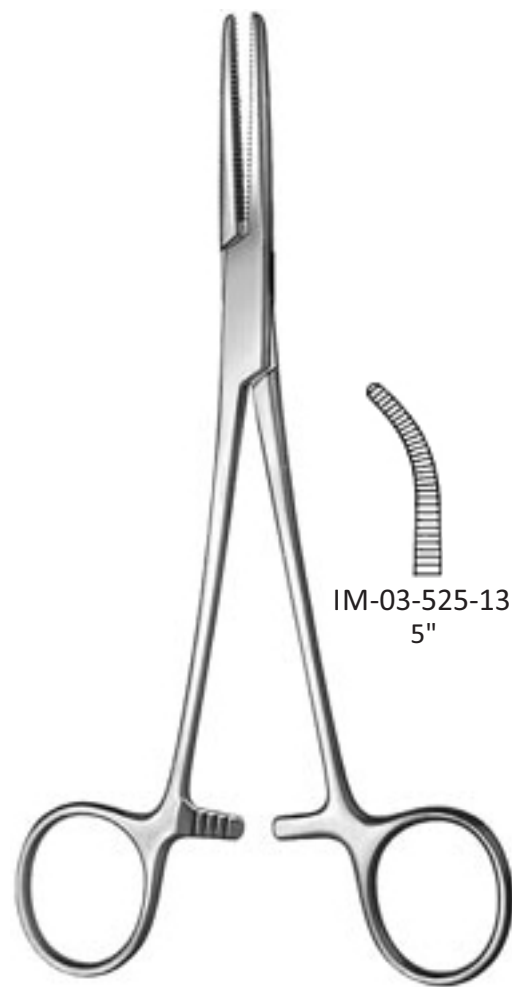
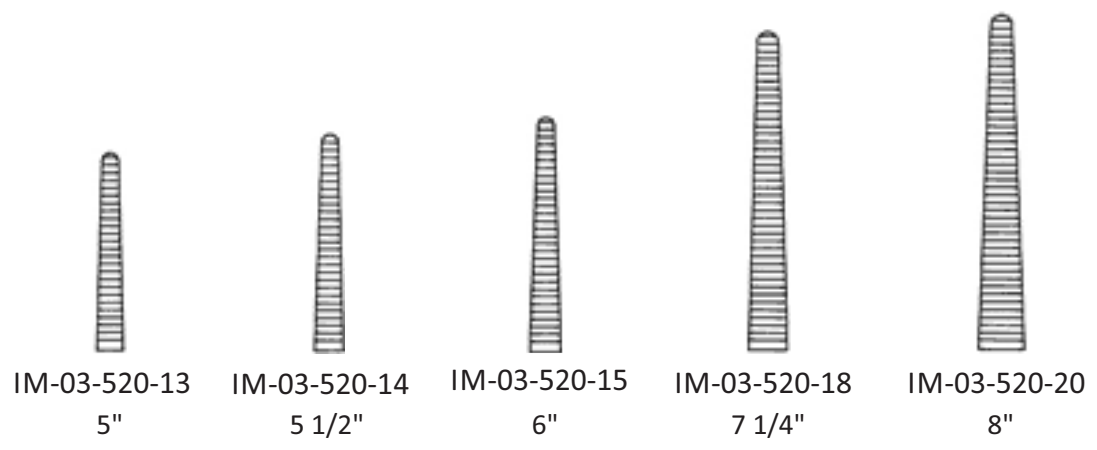

Haemostatic Forceps
Spencer-Wells

Forceps



Haemostatic Forceps
Chaput
IM-03-530-13
5"
2:3 teeth



Haemostatic Forceps
Tuffier
IM-03-532-13
5"
4:5 teeth

Forceps

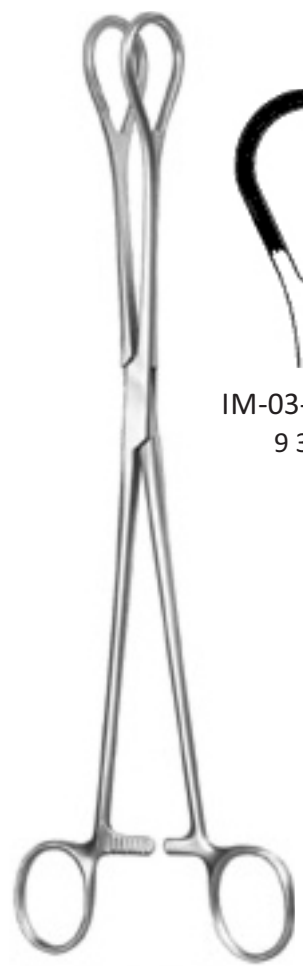

Organ Grasping Forceps

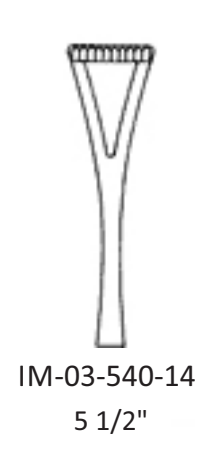

Organ Grasping Forceps
Collin

Forceps



IM-03-545-15
6"



IM-03-545-20
8 1/4"



Haemostatic Forceps
Pennington



Tumor Grasping Forceps
Collin
IM-03-550-17
6 3/4"

Forceps

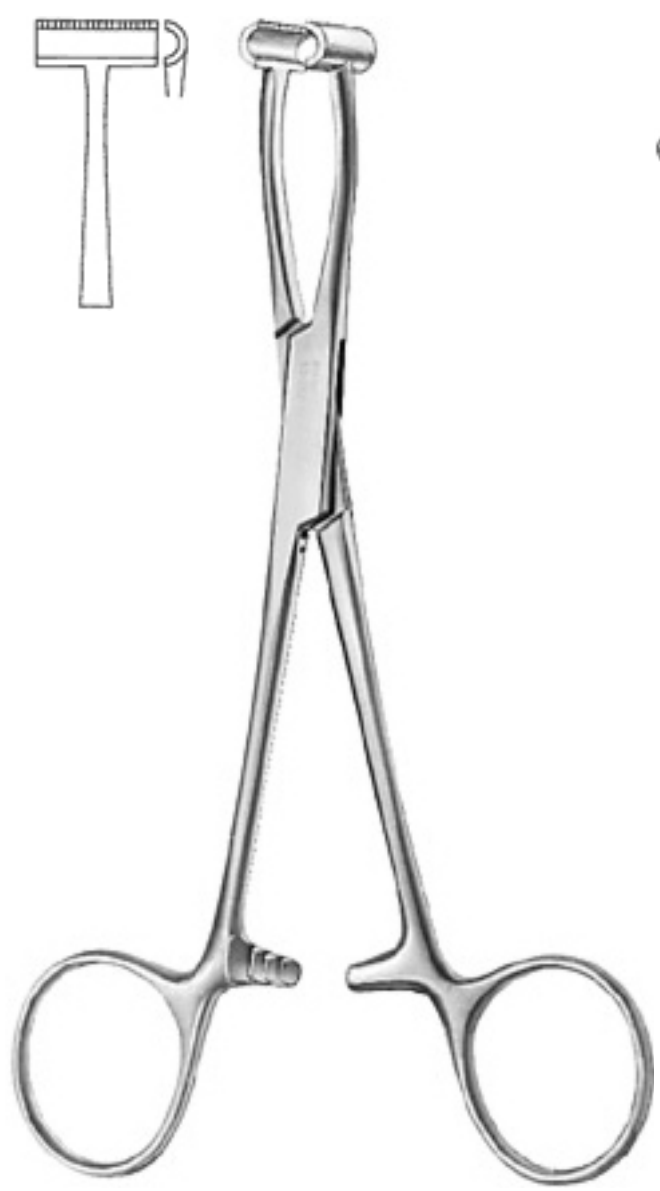

Haemostatic Forceps
Pratt
IM-03-555-15
6"

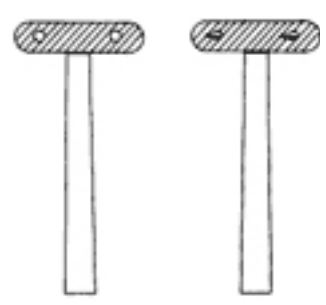

Face-lift Forceps
Martel-Rees
IM-03-555-14
5 1/4"

Forceps



Ligature Forceps
IM-03-560-12
5"

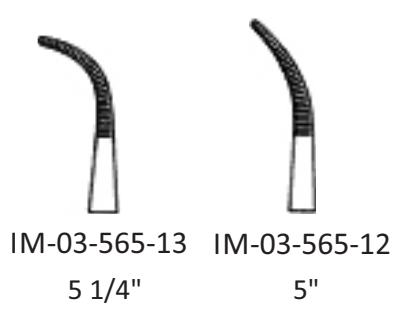

Dissecting and Ligature Forceps
Mixer-Baby

Forceps



IM-03-570-10
4"



IM-03-570-09
3 3/4"



Haemostatic Forceps
Hartmann



Ligature Forceps
IM-03-575-12
5"
cross serrated jaw

Forceps



IM-03-580-12
5"



IM-03-580-14
5 3/4"



IM-03-580-02
5"



4 3/4"



5 1/2"



4 3/4"



Haemostatic Forceps
Halsted-Mosquito



IM-03-584-12
5"
1:2 teeth



IM-03-584-14
5 3/4"
1:2 teeth



IM-03-584-02
4 3/4"
1:2 teeth



IM-03-586-12
4 3/4"
1:2 teeth



IM-03-586-14
5 1/2"
1:2 teeth







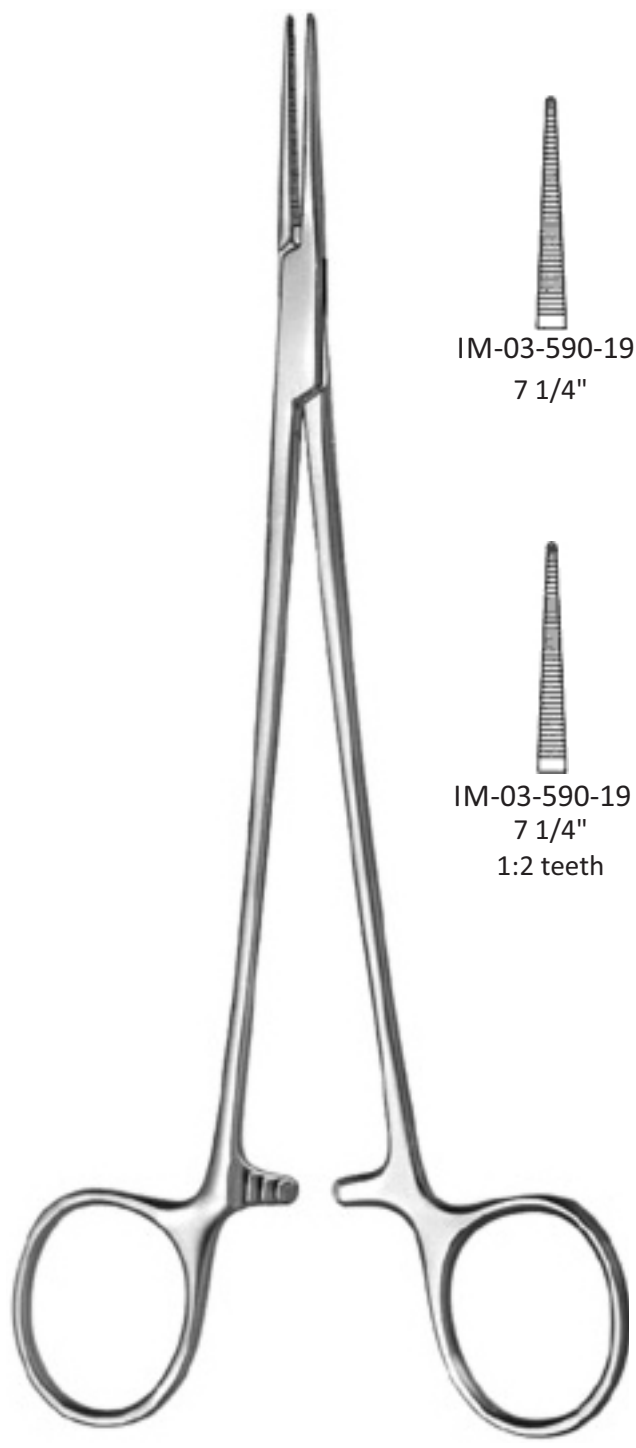

IM-03-586-02
4 3/4"
1:2 teeth

Forceps



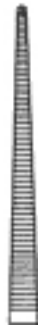





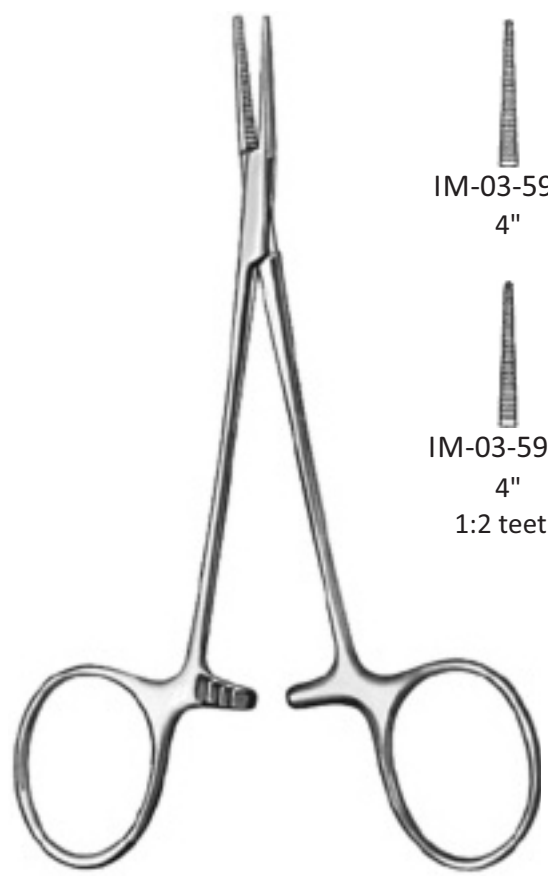

Haemostatic Forceps
Halsted-Mosquito

				
	IM-03-590-19 7 1/4"	IM-03-590-21 8 1/4"	IM-03-590-18 7"	IM-03-590-20 8"
				
	IM-03-590-19 7 1/4" 1:2 teeth	IM-03-590-22 8 1/4" 1:2 teeth	IM-03-590-18 7" 1:2 teeth	IM-03-592-20 8" 1:2 teeth

Forceps



Haemostatic Forceps
Micro-Mosquito

			
IM-03-595-10 4"	IM-03-595-11 4 3/4"	IM-03-595-09 3 3/4"	IM-03-595-11 4 1/2"
			
IM-03-597-10 4" 1:2 teeth	IM-03-597-11 4 3/4" 1:2 teeth	IM-03-597-09 4" 1:2 teeth	IM-03-597-11 4 3/4" 1:2 teeth

Forceps



Haemostatic Forceps



Providence-Hospital
IM-03-600-13
5 1/2"



Providence-Hospital
IM-03-602-13
5 1/2"



Leriche
IM-03-604-15
6"



Leriche
IM-03-606-15
6"



Leriche
IM-03-608-15
6"



Leriche
IM-03-610-15
6"

Forceps



Haemostatic Forceps
Kelly



IM-03-615-14
5 3/4"



IM-03-617-14
5 3/4"



IM-03-619-13
5 1/2"



IM-03-621-13
5 1/2"



Kelly-Rankin
IM-03-623-16
6 1/4"



Kelly-Rankin
IM-03-625-15
6"

Forceps



Dissecting and Ligature Forceps
Overholt-Baby
IM-03-630-14
5 1/2"

Forceps



Haemostatic Forceps
Crile

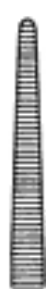

5 3/4"
IM-03-635-14



5 3/4"
IM-03-636-14



IM-03-637-14
5 1/2"



IM-03-638-14
5 1/2"



IM-03-639-14
5 3/4"
teeth



IM-03-640-14
5 1/2"
teeth

Forceps



IM-03-645-16
6 1/2"



IM-03-647-16
6 1/4"



Haemostatic Forceps
Crile-Rankin

Forceps



Haemostatic Forceps
Lovelace



IM-03-650-16
6 1/4"



IM-03-652-16
6 1/4"
1:2 teeth

Forceps

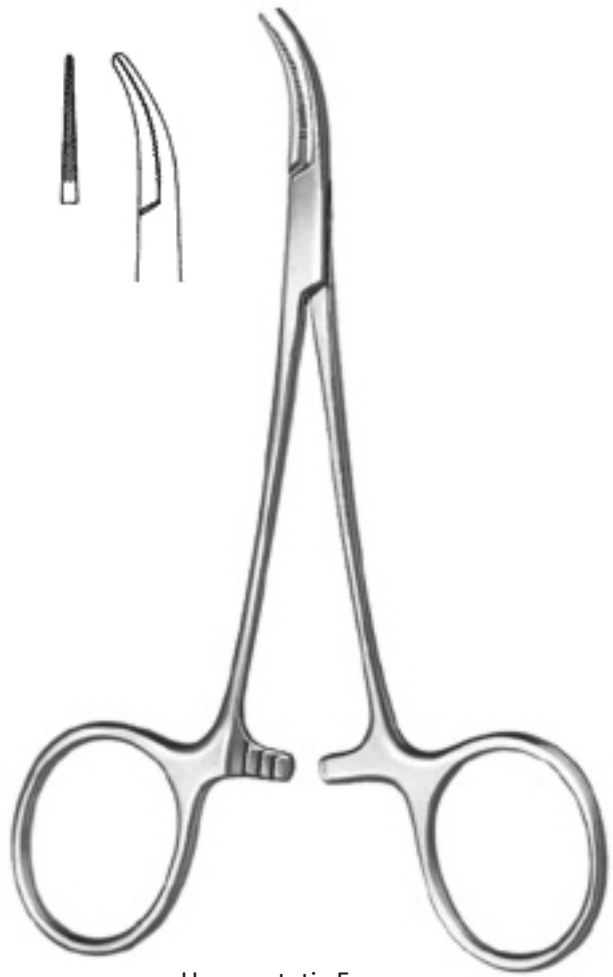

Haemostatic Forceps
Dandy-Mosquito
IM-03-655-12
4 3/4"
laterally curved



Haemostatic Forceps
Dandy

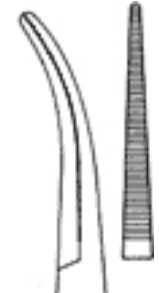

IM-03-655-14
5 3/4"
laterally curved

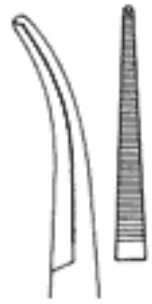

IM-03-657-14
5 1/2"
laterally curved 1:2 teeth

Forceps



Dissecting and Ligature Forceps
Schnidt

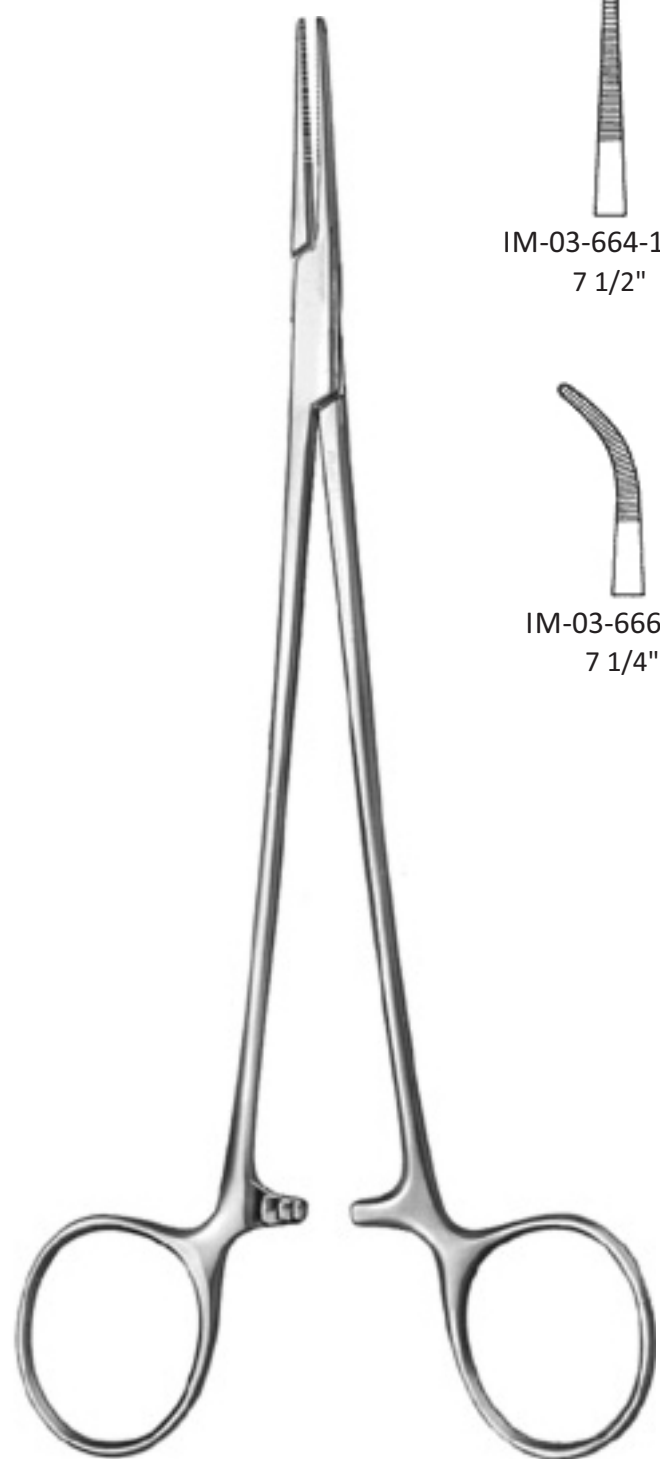
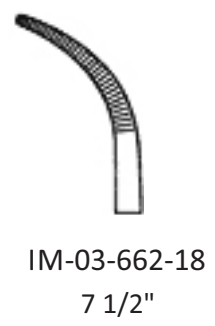

Dissecting and Ligature Forceps
Adson



Forceps



Dissecting and Ligature Forceps
Martin-Fuchsig
IM-03-670-20
8"

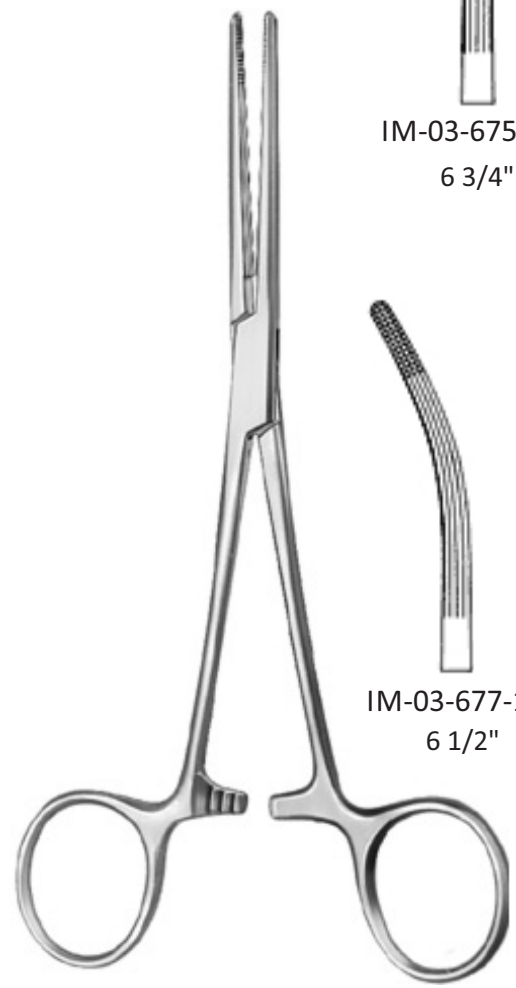

Haemostatic Forceps
Rochester-Carmalt

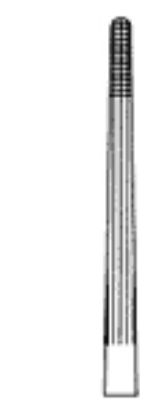

IM-03-675-16
6 3/4"



IM-03-675-20
8"



IM-03-677-16
6 1/2"



IM-03-675-20
8"

Forceps

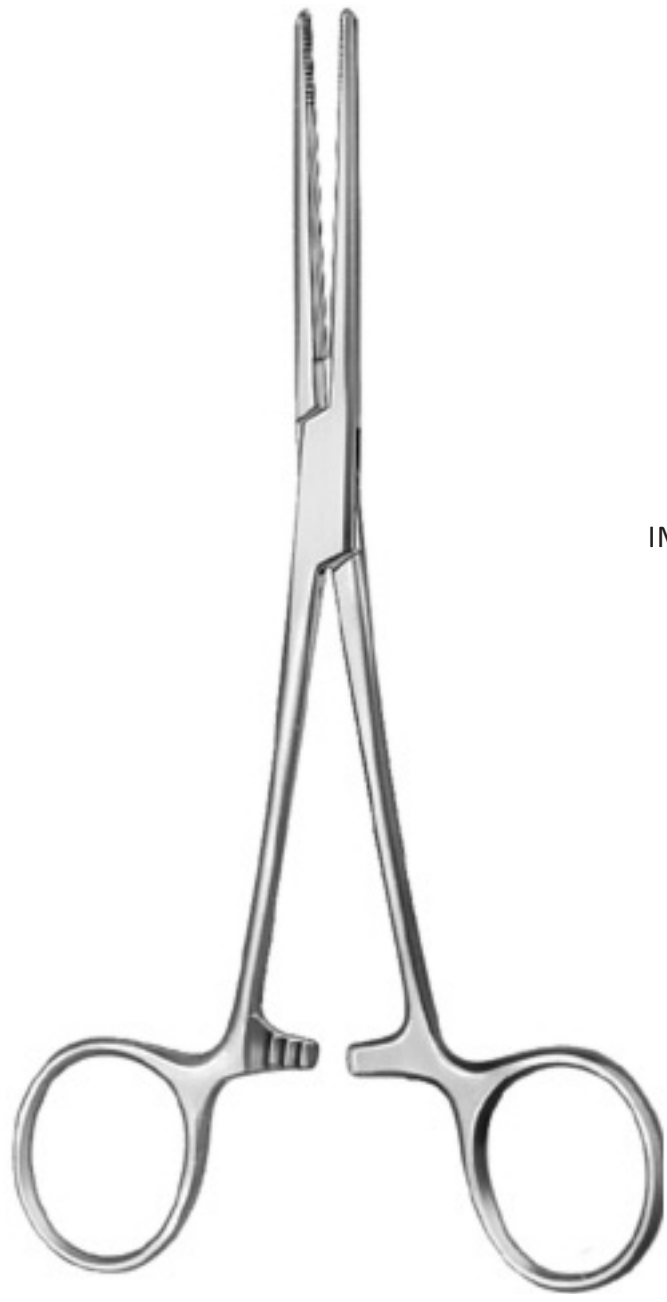

Haemostatic Forceps
Rochester-Carmalt

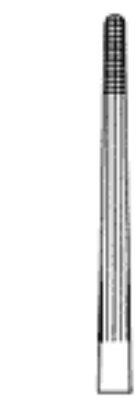

IM-03-680-16
6 3/4"



IM-03-680-20
8"



IM-03-682-16
6 1/2"



IM-03-682-20
8"

Forceps



Haemostatic Forceps
Pean



IM-03-685-13
5 1/4"



IM-03-685-14
5 3/4"



IM-03-685-16
6 3/4"



IM-03-690-13
5"



IM-03-690-14
5 1/2"



IM-03-690-16
6 1/2"

Forceps



IM-03-695-14
5 3/4"

IM-03-695-16
6 1/2"

IM-03-695-18
7 1/4"

IM-03-700-14
5 1/2"

IM-03-700-16
6 1/4"





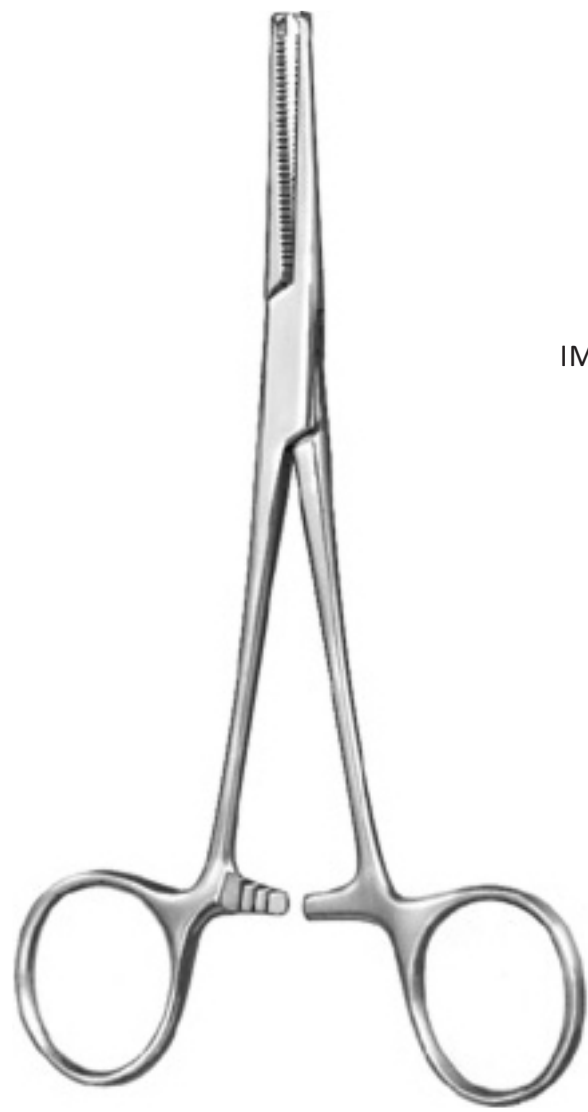

IM-03-700-18
7"

Haemostatic Forceps
Pean-Nippon

Forceps



Haemostatic Forceps
Kocher-Nippon

		
IM-03-705-14 5 3/4" 1:2 teeth	IM-03-705-16 6 1/2" 1:2 teeth	IM-03-705-18 7 1/4" 1:2 teeth
		
IM-03-710-14 5 1/2" 1:2 teeth	IM-03-710-16 6 1/4" 1:2 teeth	IM-03-710-18 7" 1:2 teeth

Forceps



Haemostatic Forceps
Kocher



IM-03-715-14
5"
1:2 teeth



IM-03-715-16
5 1/2"
1:2 teeth



IM-03-715-18
6 1/4"
1:2 teeth



IM-03-720-13
5"
1:2 teeth



IM-03-720-14
5 1/2"
1:2 teeth



IM-03-720-16
6 1/4"
1:2 teeth

Forceps



Haemostatic Forceps
Kocher



IM-03-715-14
5"
1:2 teeth



IM-03-715-16
5 1/2"
1:2 teeth



IM-03-715-18
6 1/4"
1:2 teeth



IM-03-720-13
5"
1:2 teeth



IM-03-720-14
5 1/2"
1:2 teeth



IM-03-720-16
6 1/4"
1:2 teeth

Forceps



Haemostatic Forceps
Bengolea



IM-03-725-20
8 1/2"



IM-03-725-26
10 1/4"



IM-03-727-20
8 1/4"



IM-03-727-26
10"



IM-03-729-20
8 1/2"
1:2 teeth



IM-03-729-26
10 1/4"
1:2 teeth



IM-03-730-20
8 1/4"
1:2 teeth



IM-03-730-26
10"
1:2 teeth

Forceps



IM-03-735-14
5 3/4"



IM-03-735-16
6 1/2"



IM-03-735-18
7 1/4"



IM-03-735-20
8"



Haemostatic Forceps
Pean (Rochester)



IM-03-735-22
8 3/4"



IM-03-735-54
9 3/4"



IM-03-735-26
10 1/4"



IM-03-735-30
12"

Forceps



Haemostatic Forceps
Pean (Rochester)



IM-03-740-14
5 1/2"

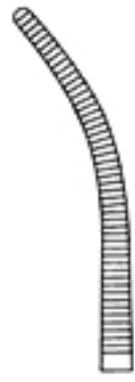

IM-03-740-16
6 1/4"

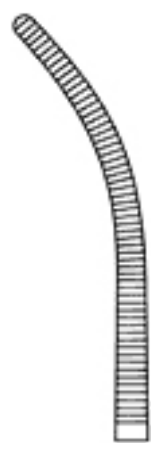

IM-03-740-18
7"

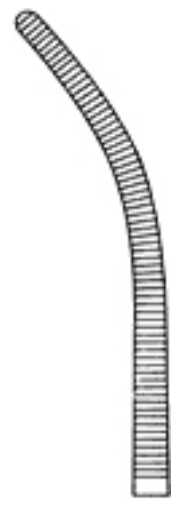

IM-03-740-20
8"

Forceps

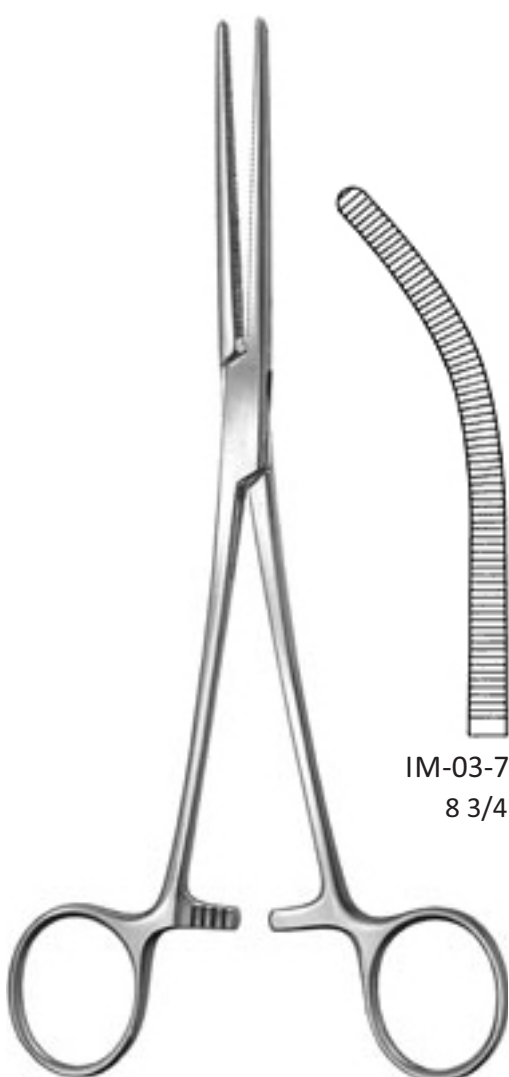

Haemostatic Forceps
Pean (Rochester)

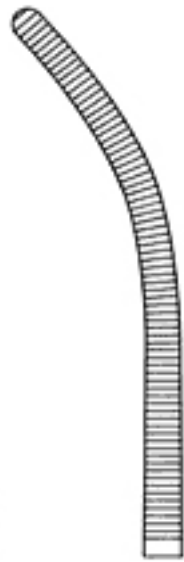

IM-03-740-22
8 3/4"

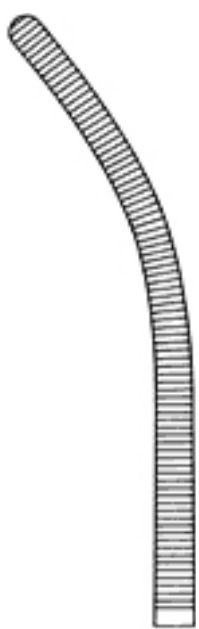

IM-03-740-24
9 1/2"

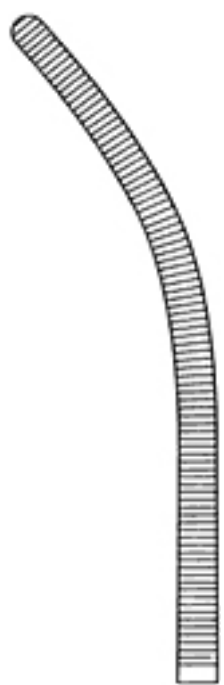

IM-03-740-25
10"

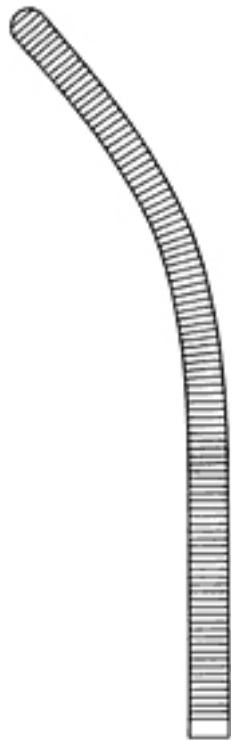

IM-03-740-28
11 3/4"

Forceps

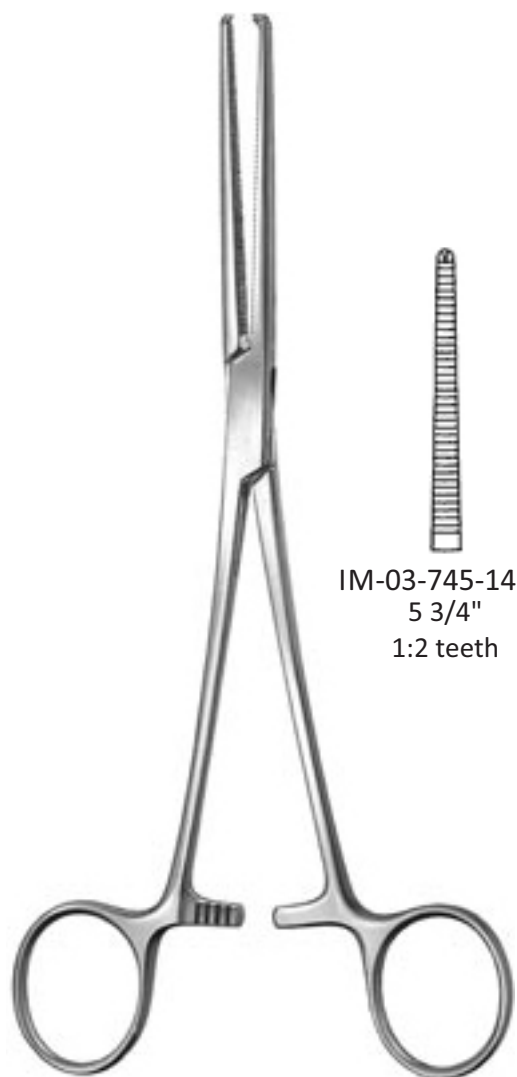

Haemostatic Forceps
Kocher (Ochsner)



IM-03-745-14
5 3/4"
1:2 teeth



IM-03-745-16
6 1/2"
1:2 teeth



IM-03-745-18
7 1/4"
1:2 teeth



IM-03-745-20
8"
1:2 teeth

Forceps

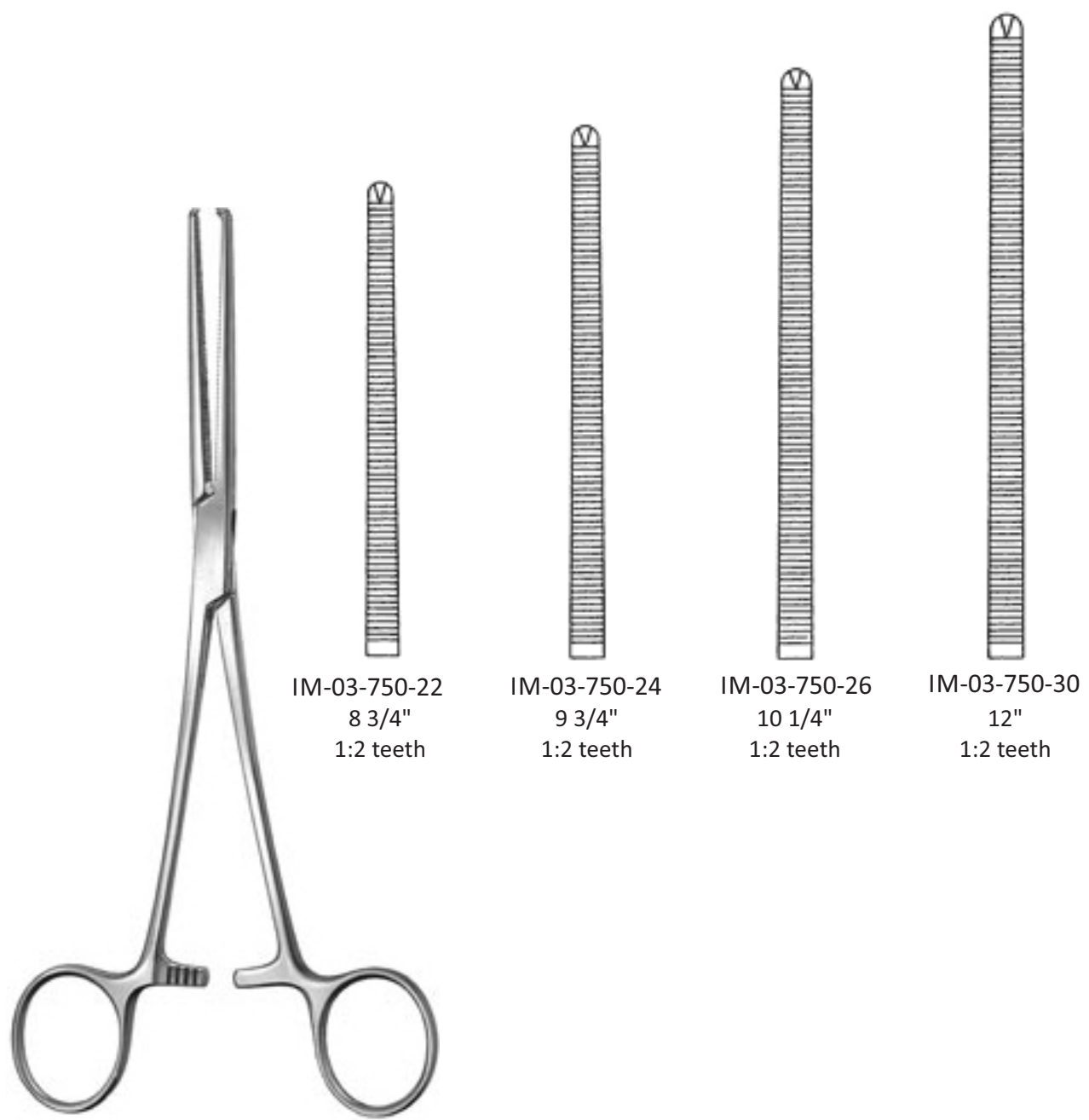

IM-03-750-22
8 3/4"
1:2 teeth

IM-03-750-24
9 3/4"
1:2 teeth

IM-03-750-26
10 1/4"
1:2 teeth

IM-03-750-30
12"
1:2 teeth

Haemostatic Forceps
Kocher (Ochsner)

Forceps

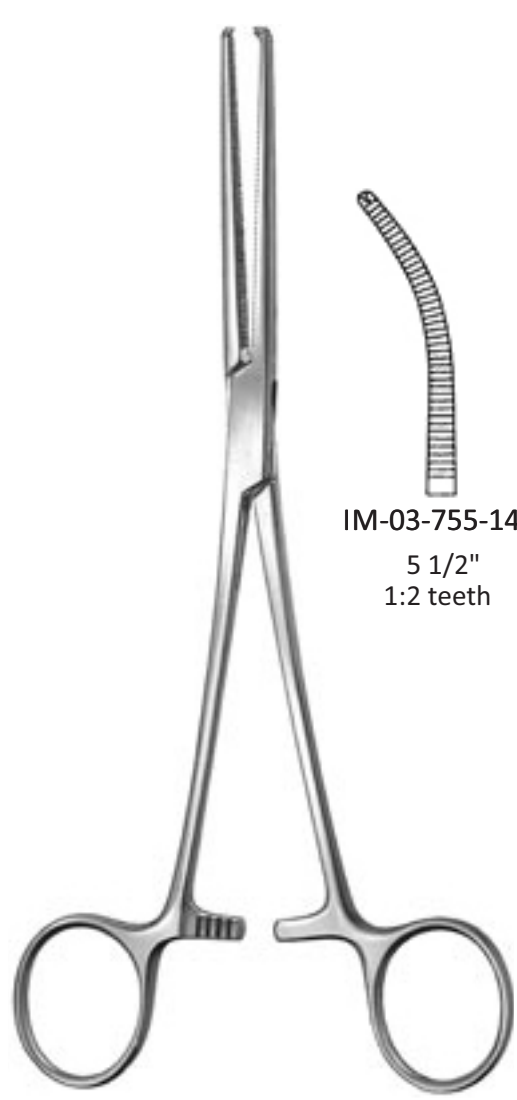

Haemostatic Forceps
Kocher (Ochsner)



IM-03-755-14
5 1/2"
1:2 teeth



IM-03-755-16
6 1/4"
1:2 teeth



IM-03-755-18
7"
1:2 teeth

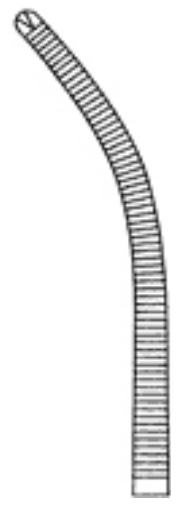

IM-03-755-20
8"
1:2 teeth

Forceps



Haemostatic Forceps
Kocher (Ochsner)

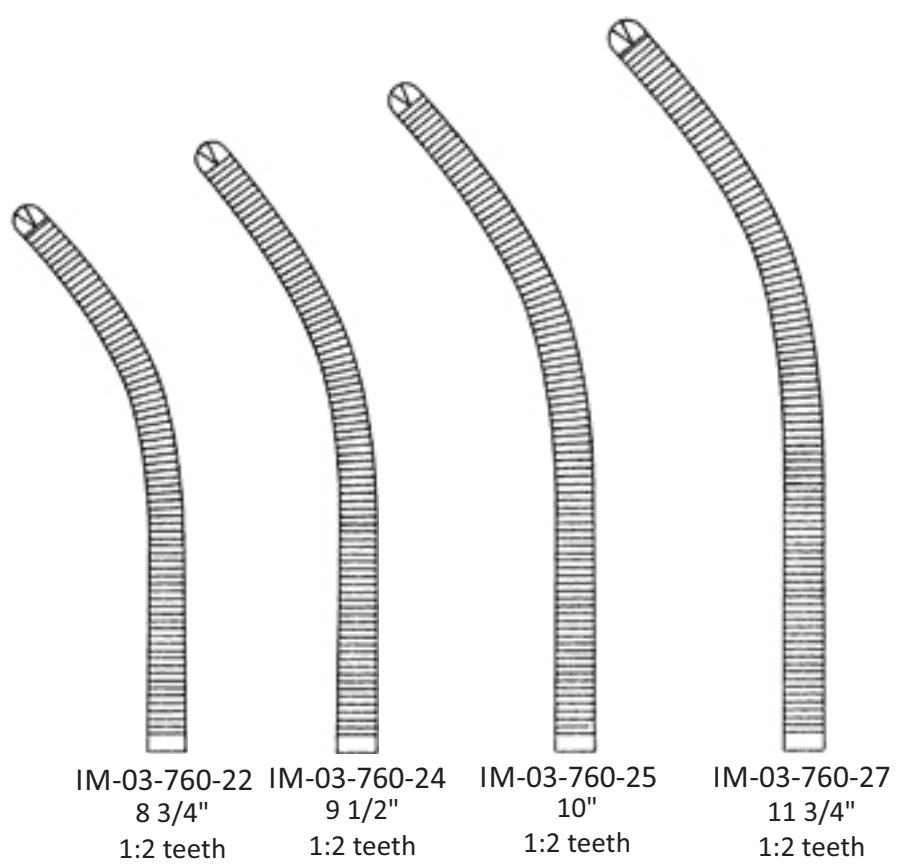

Forceps



Dissecting and Ligature Forceps
Overholt-Martin

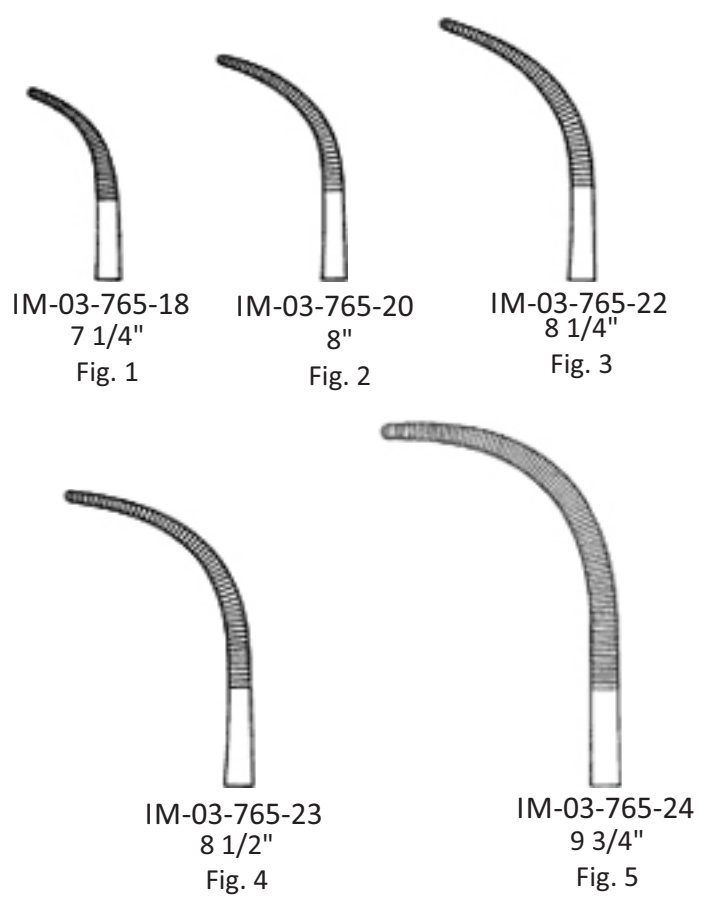

Forceps



Dissecting and Ligature Forceps
Mixer-Baby
IM-03-770-18
7 1/4"

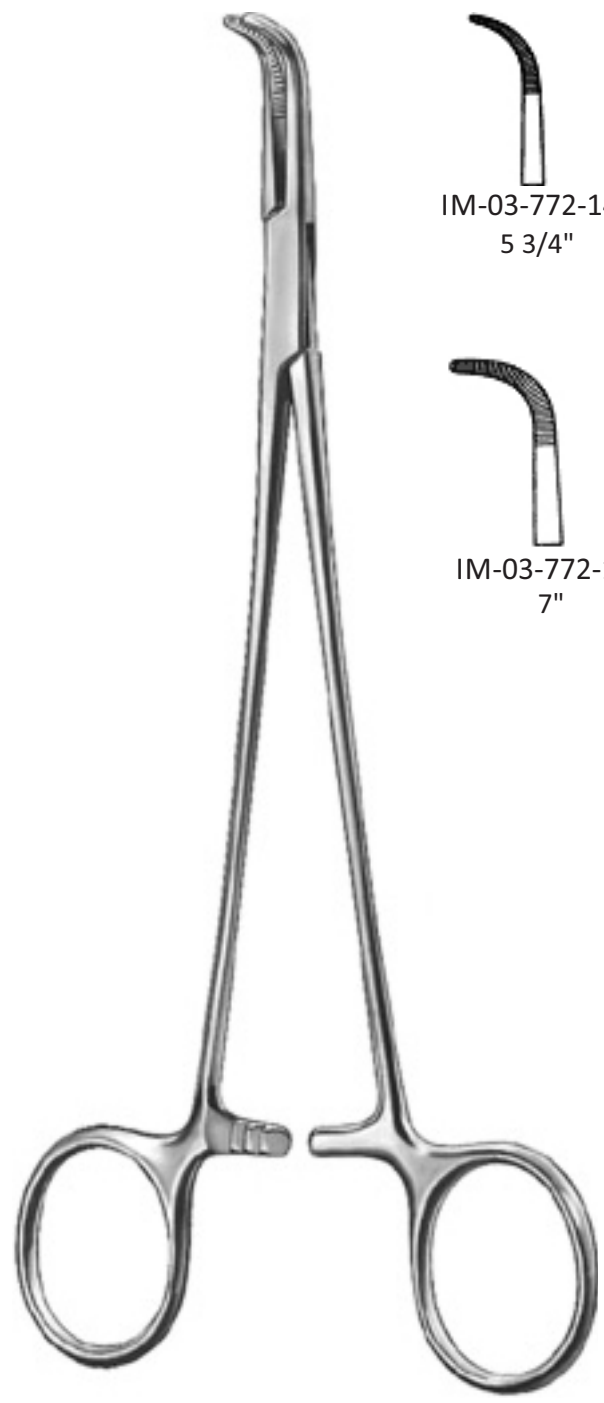

Dissecting and Ligature Forceps
Adson-Baby

IM-03-772-14
5 3/4"

IM-03-772-18
7"

Forceps



Dissecting and Ligature Forceps
Heiss



IM-03-775-21
8 1/4"



IM-03-777-20
8"



IM-03-779-20
8"

Forceps



Dissecting and Ligature Forceps
Heiss



IM-03-775-21
8 1/4"



IM-03-777-20
8"



IM-03-779-20
8"

Forceps



Dissecting and Ligature Forceps
Craford



IM-03-780-18
7"



IM-03-780-23
9 3/4"

Forceps

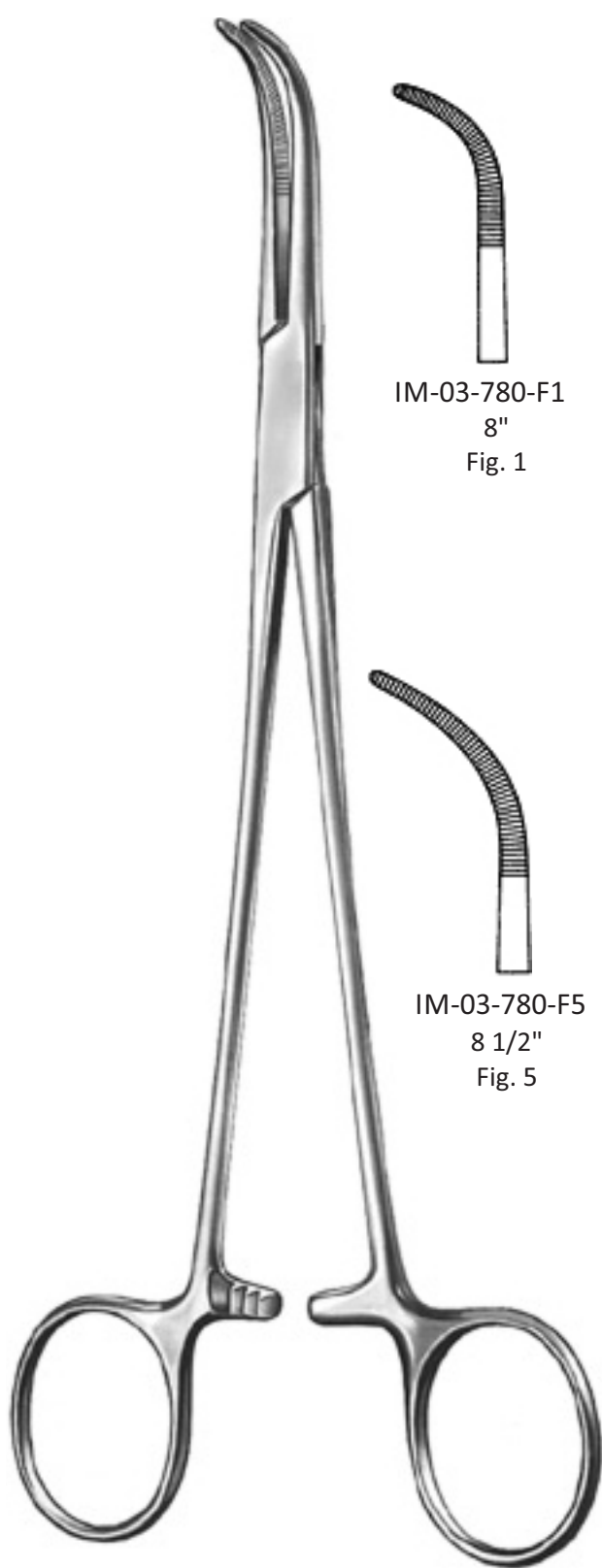

IM-03-780-F1
8"
Fig. 1



IM-03-780-F2
8"
Fig. 2



IM-03-780-F3
8 1/2"
Fig. 3



IM-03-780-F4
8 3/4"
Fig. 4

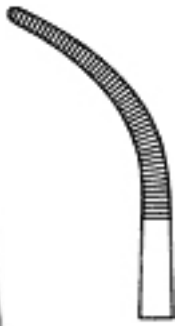

IM-03-780-F5
8 1/2"
Fig. 5



IM-03-780-F6
8 3/4"
Fig. 6



IM-03-780-F7
8 3/4"
Fig. 7



IM-03-780-F1
10 3/4"
Fig. 8

Dissecting and Ligature Forceps
Overholt-Geissendörfer

Forceps

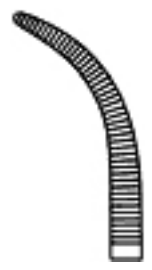
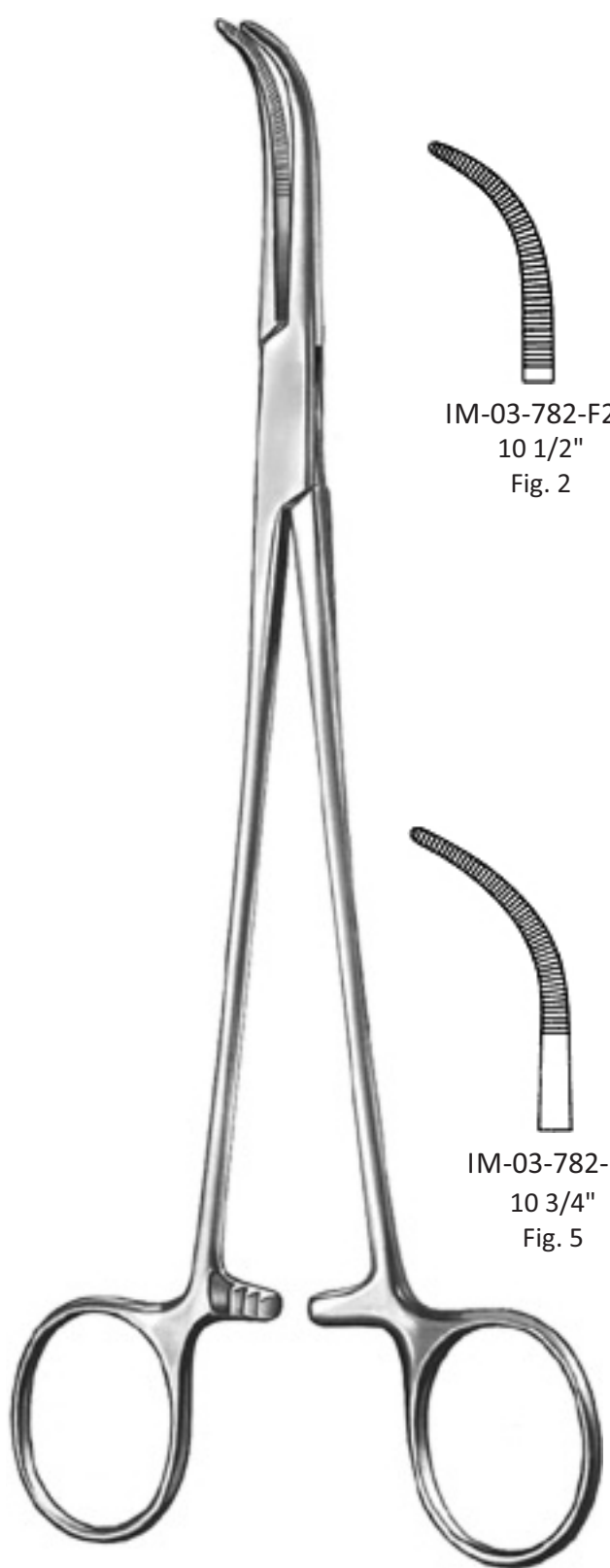

IM-03-782-F2
10 1/2"
Fig. 2

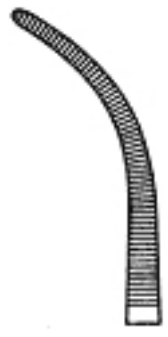

IM-03-782-F3
10 3/4"
Fig. 3



IM-03-782-F4
11"
Fig. 4

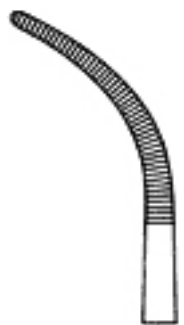

IM-03-782-F5
10 3/4"
Fig. 5

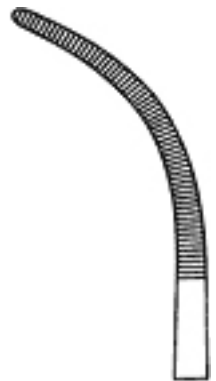

IM-03-7802-F6
11"
Fig. 6



IM-03-782-F7
10 3/4"
Fig. 7

Dissecting and Ligature Forceps
Overholt-Geissendörfer

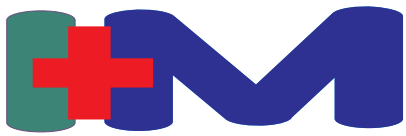

Forceps



Dissecting and Ligature Forceps
Overholt-Fino



ZI-04-448-00
8 1/2"



ZI-04-448-01
8 1/4"



ZI-04-448-02
8 1/2"



IM-03-785-23
9"



IM-03-785-22
8 3/4"

Forceps



Dissecting and Ligature Forceps
Overholt

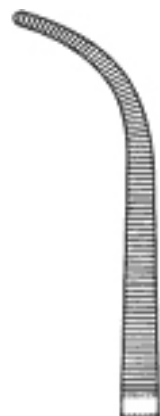

IM-03-790-00
11 1/2"

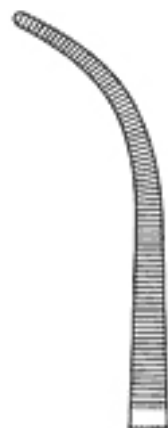

IM-03-790-01
11 1/2"

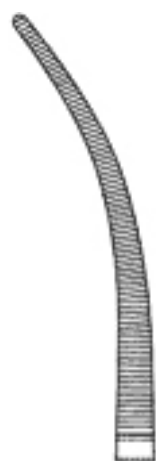

IM-03-790-06
11 3/4"

Forceps



Dissecting and Ligature Forceps
Overholt-Mini
IM-03-795-01
6"



Dissecting and Ligature Forceps
Overholt-Mini
IM-03-795-02
8"

Forceps

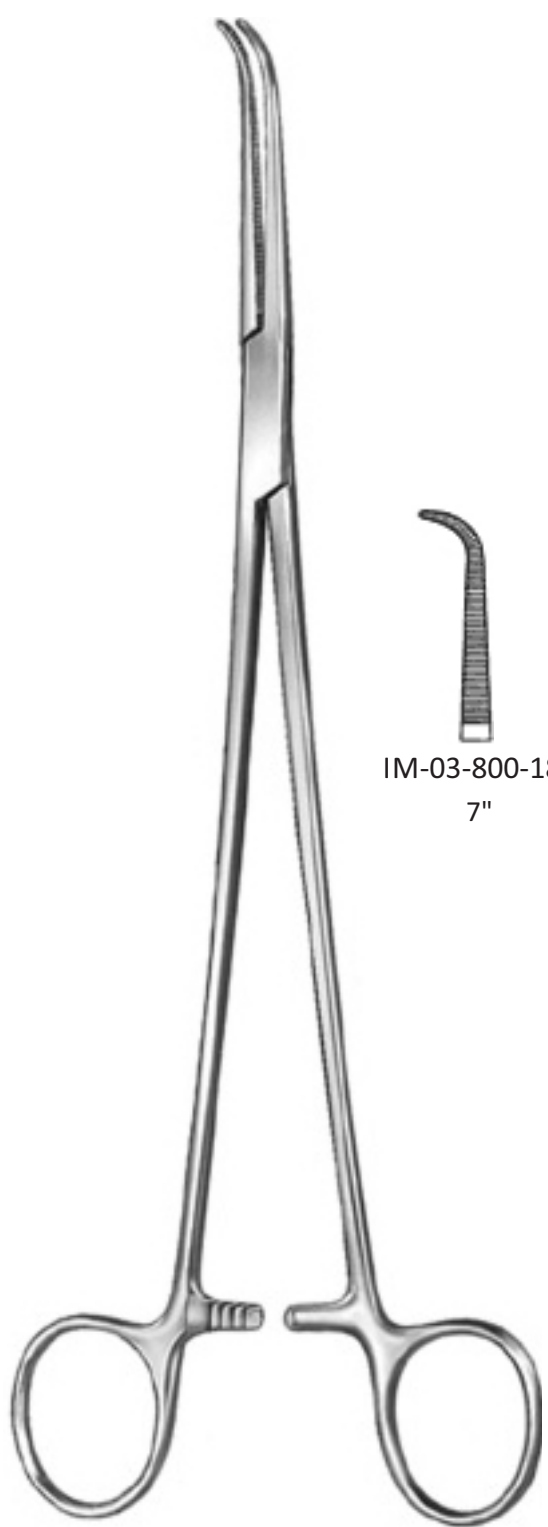

Dissecting and Ligature Forceps
Mini-Gemini

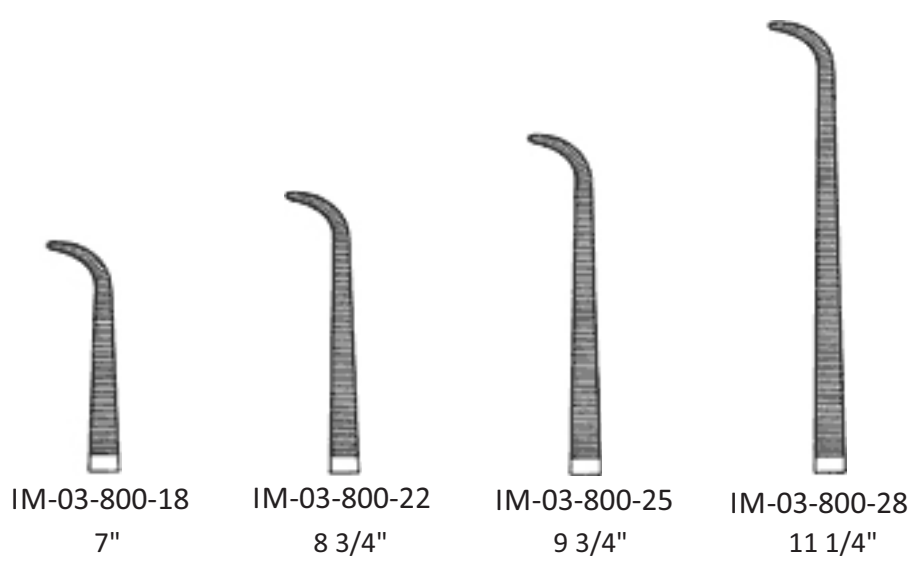

Forceps



Dissecting and Ligature Forceps
Rumel



IM-03-805-F1
9 1/2"
Fig. 1



IM-03-805-F2
9 1/4"
Fig. 2

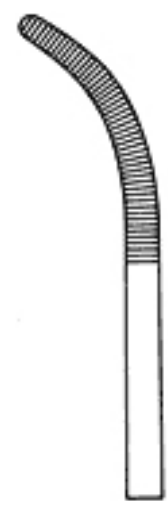

IM-03-805-F3
9"
Fig. 3

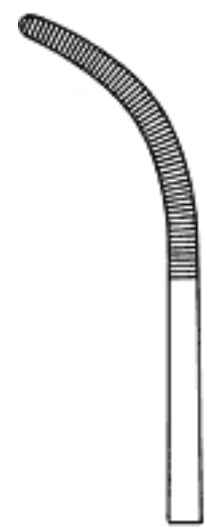

IM-03-805-F4
9 1/2"
Fig. 4



IM-03-805-F5
9 1/4"
Fig. 5

Forceps



Dissecting and Ligature Forceps
Zenker

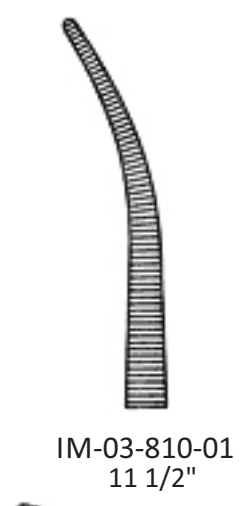

IM-03-810-01
11 1/2"



IM-03-810-02
11 1/4"



Dissecting and Ligature Forceps
Mixer-Baby
IM-03-815-14
5 1/4"

Forceps

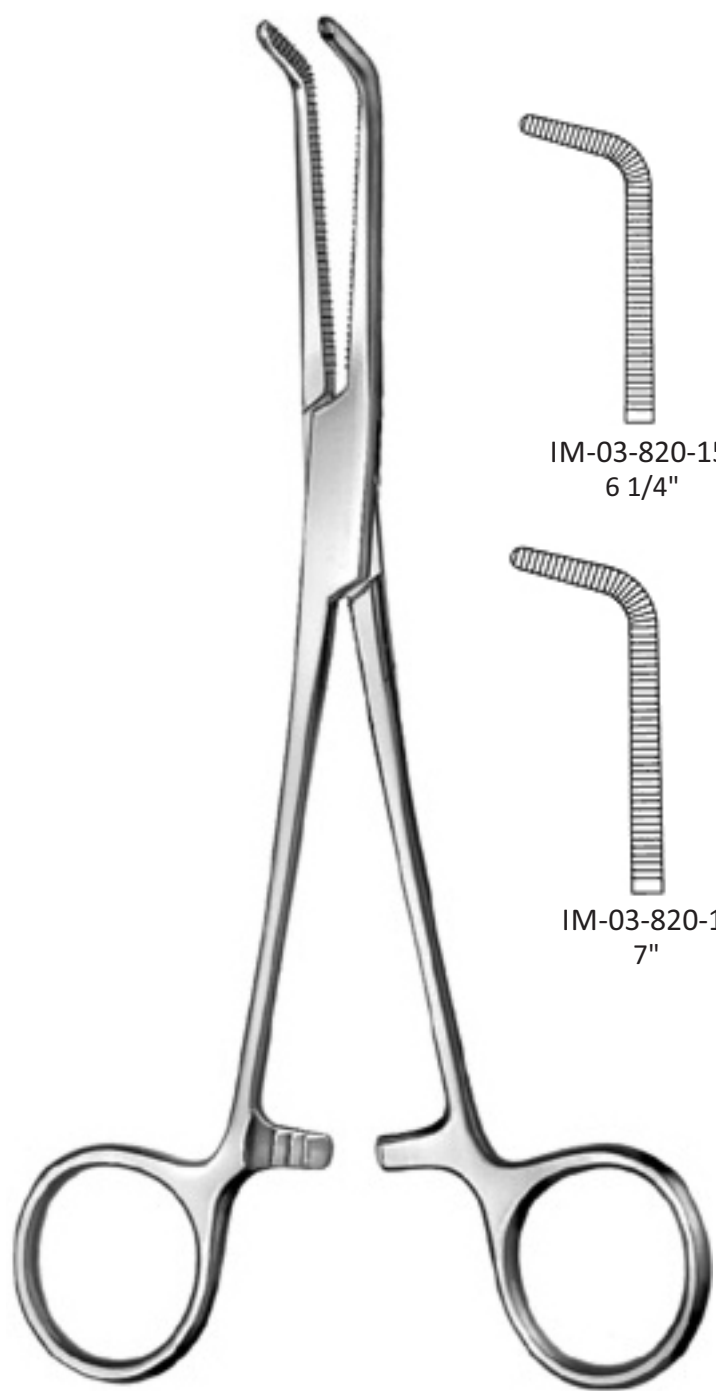

Dissecting and Ligature Forceps
Mixer



Dissecting and Ligature Forceps
Mixer-O'Shaughnessy
IM-04-822-19

Forceps

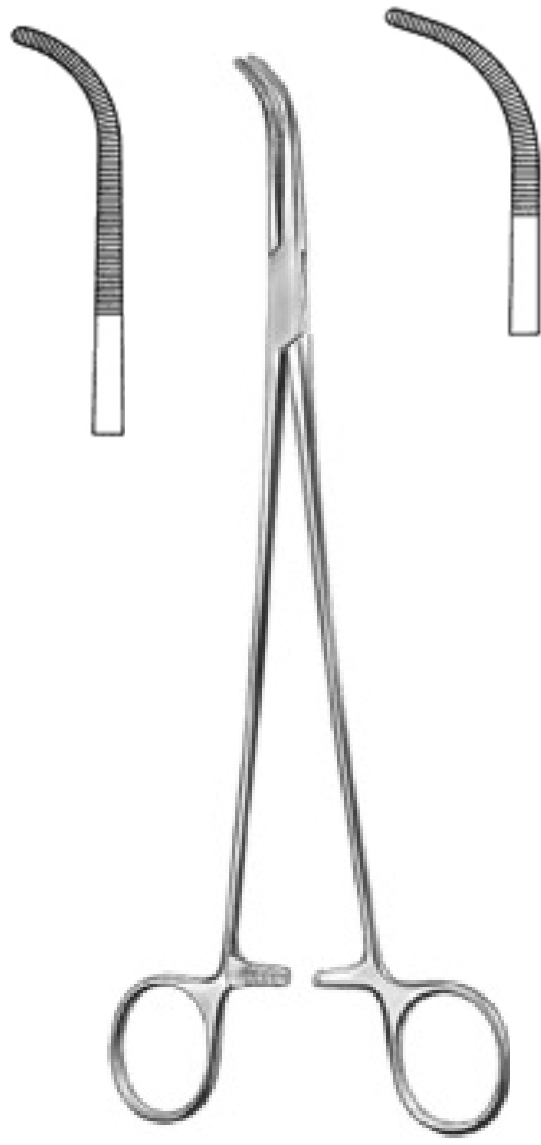

IM-03-825-22 IM-03-825-23
8 3/4" 9"
Dissecting and Ligature Forceps
Mixer

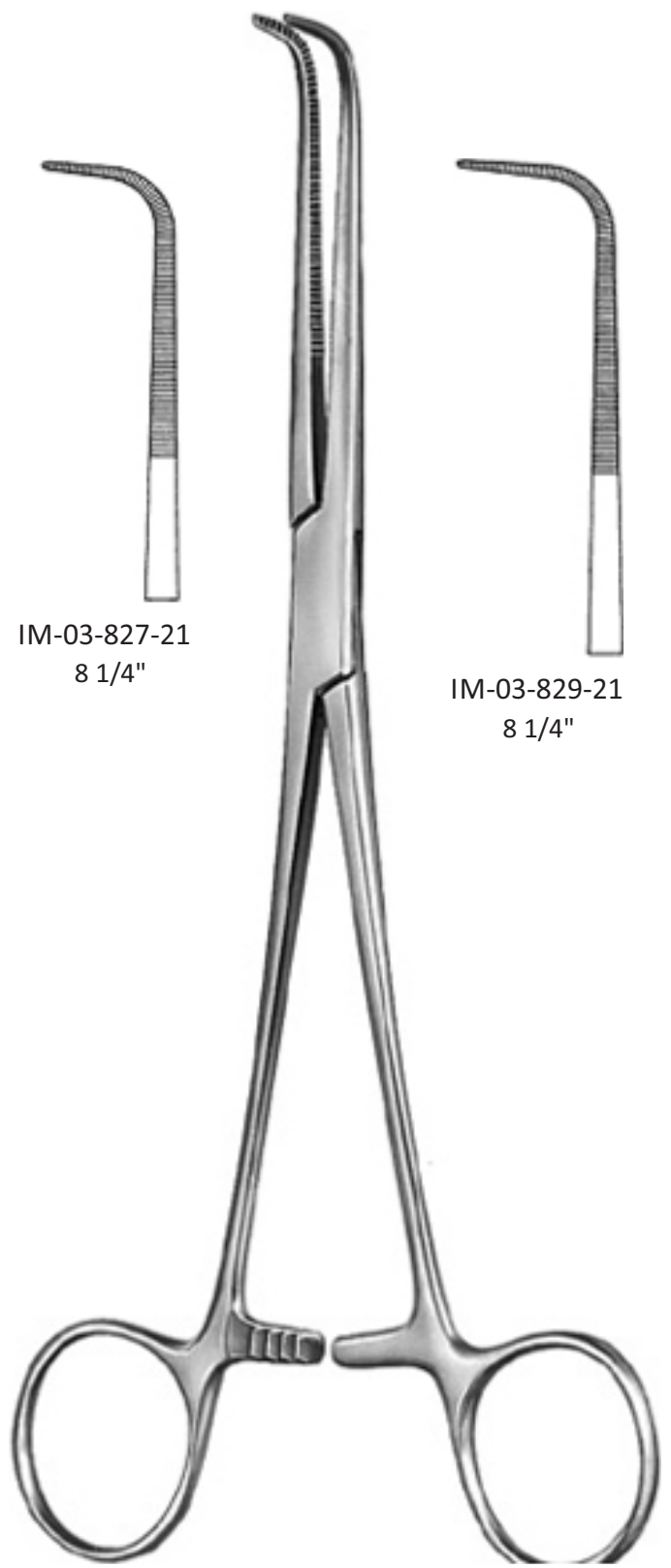

IM-03-827-21 IM-03-829-21
8 1/4" 8 1/4"

Dissecting and Ligature Forceps
Wickström

Forceps



Dissecting and Ligature Forceps
Mixer

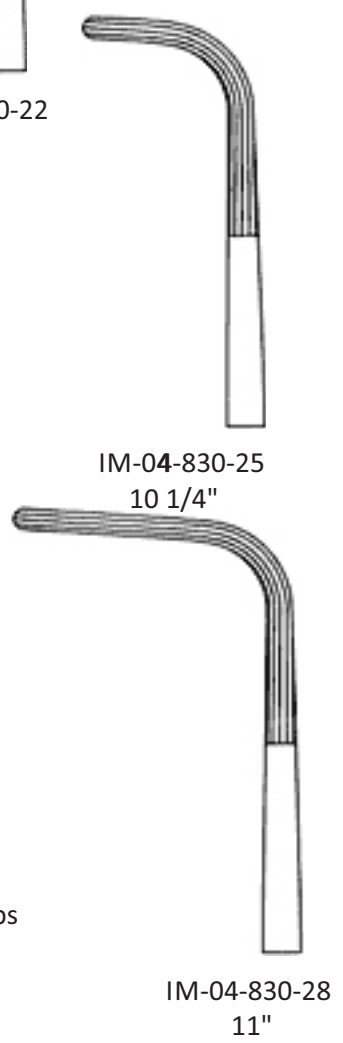

Forceps



Dissecting and Ligature Forceps
Lower
IM-04-840-18
7 1/4"

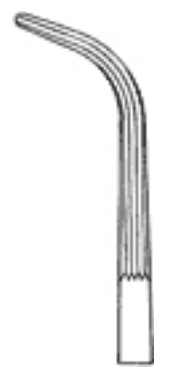

IM-04-843-19
7 3/4"

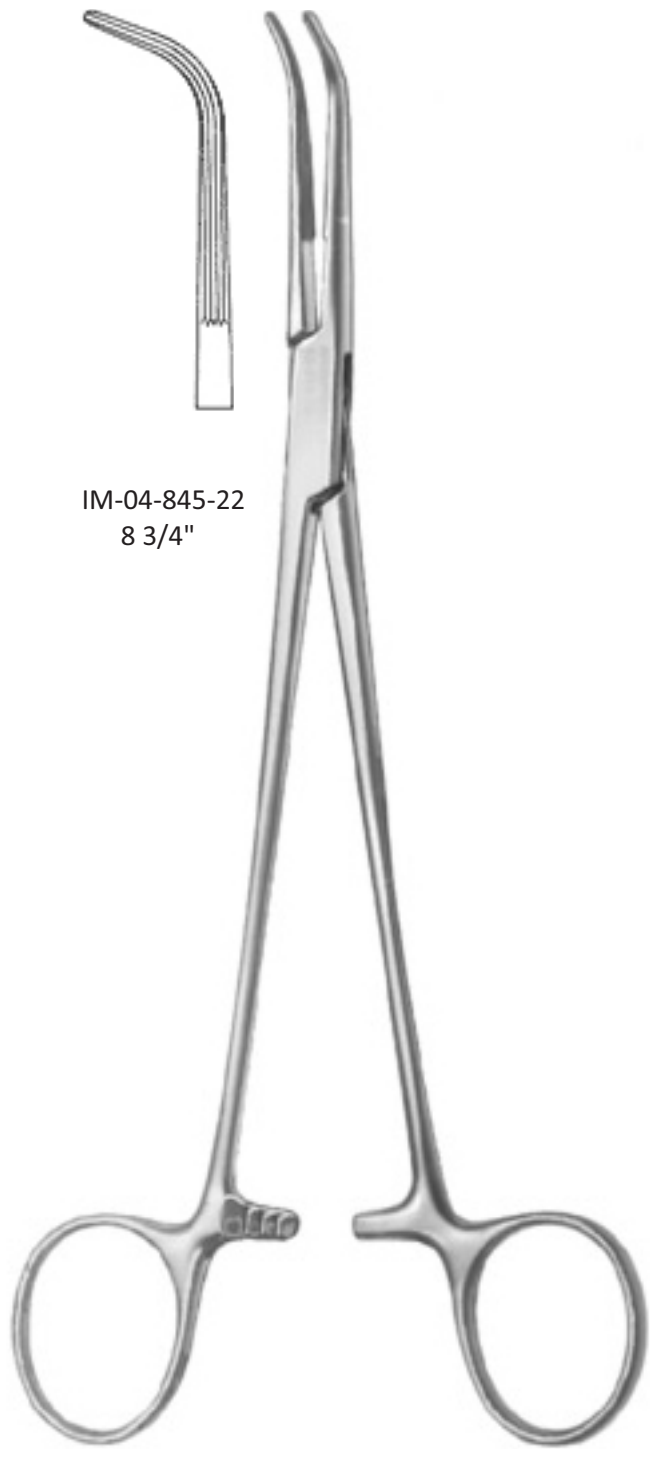

Bile Duct Clamp
Lahey



IM-04-845-22
8 3/4"

Forceps

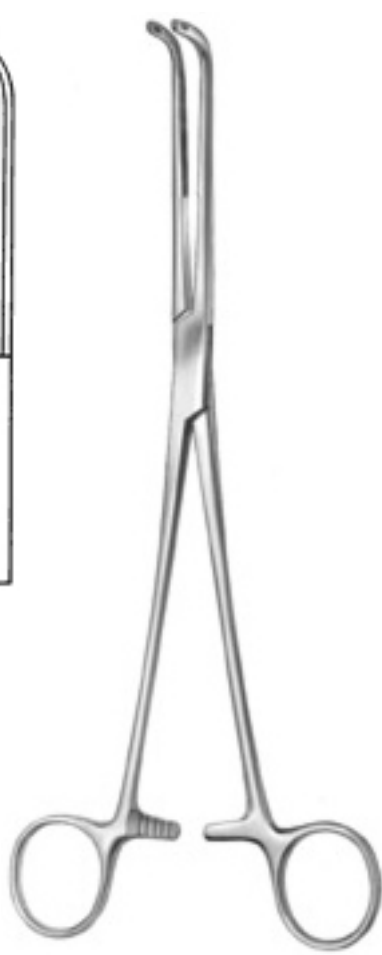
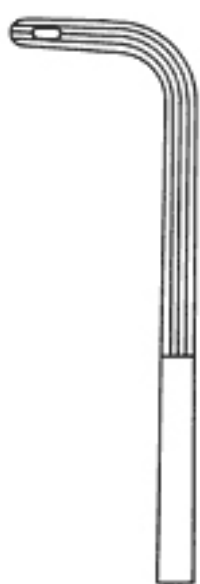

Dissecting and Ligature Forceps
Finochietto
IM-04-845-24
9 1/2"



Tangential Forceps
Uro-Tangential



IM-04-847-01
9 3/4"



IM-04-847-02
9 3/4"

Forceps



Kidney Pedicle Clamp
Guyon



IM-04-850-23
9"



IM-04-850-24
9 1/2"

Forceps



Kidney Pedicle Clamp
Guyon



IM-04-855-20
7 3/4"

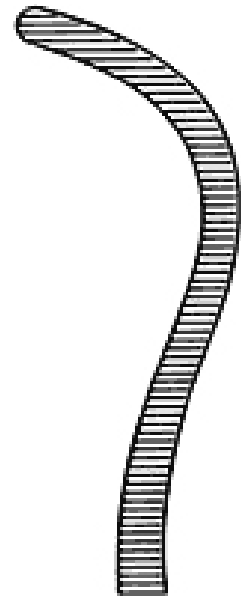

IM-04-860-22
8 1/2"



IM-04-855-24
9 1/2"

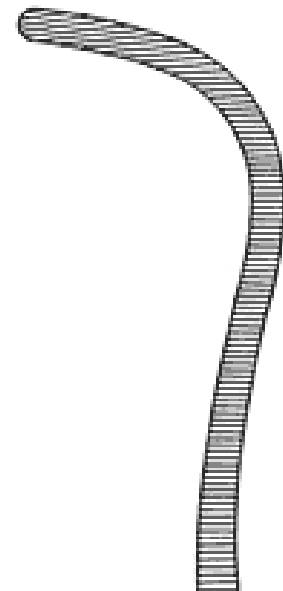

IMM-04-860-23
9 1/2"

Forceps



Bile Duct Clamp
Desjardins
IM-04-865-21
8 1/4"



Dissecting and Ligature Forceps
Kelly



IM-04-870-19
7 3/4"
Fig. 1



IM-04-870-22
8 3/4"
Fig. 1



IM-04-870-24
9 3/4"
Fig. 1

Forceps

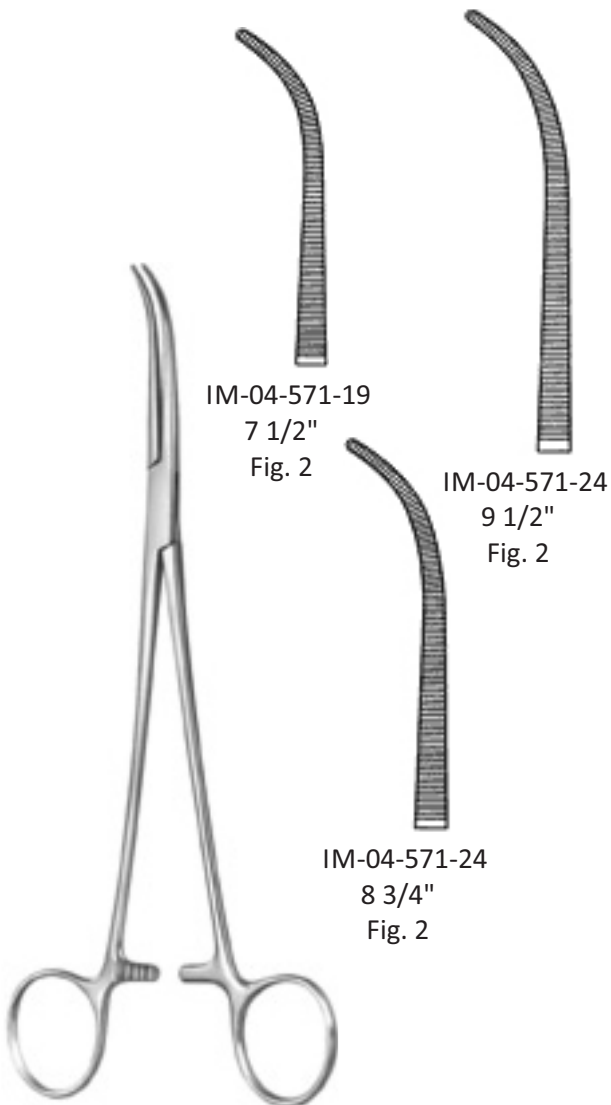

IM-04-571-19
7 1/2"
Fig. 2

IM-04-571-24
9 1/2"
Fig. 2

IM-04-571-24
8 3/4"
Fig. 2

Dissecting and Ligature Forceps
Kelly

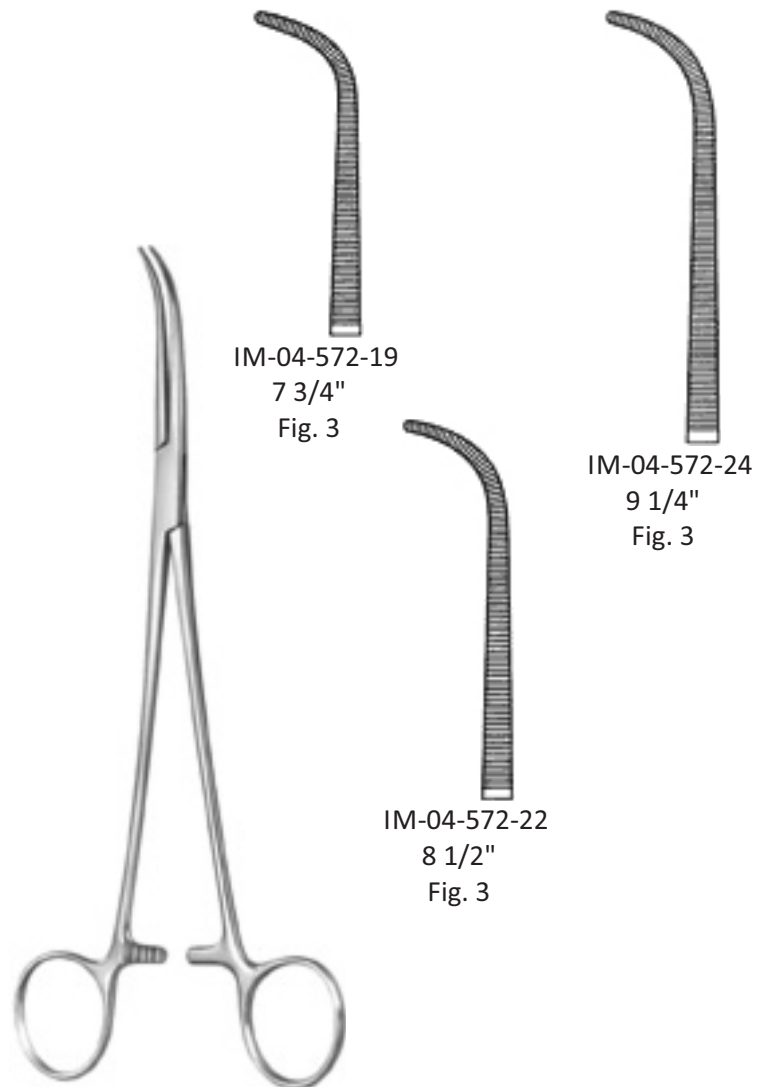

IM-04-572-19
7 3/4"
Fig. 3

IM-04-572-24
9 1/4"
Fig. 3

IM-04-572-22
8 1/2"
Fig. 3

Dissecting and Ligature Forceps
Kelly

Forceps

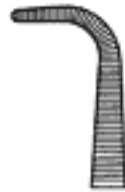

Dissecting and Ligature Forceps
IM-04-575-27
11"



Dissecting and Ligature Forceps
Meeker
IM-04-575-28

Forceps

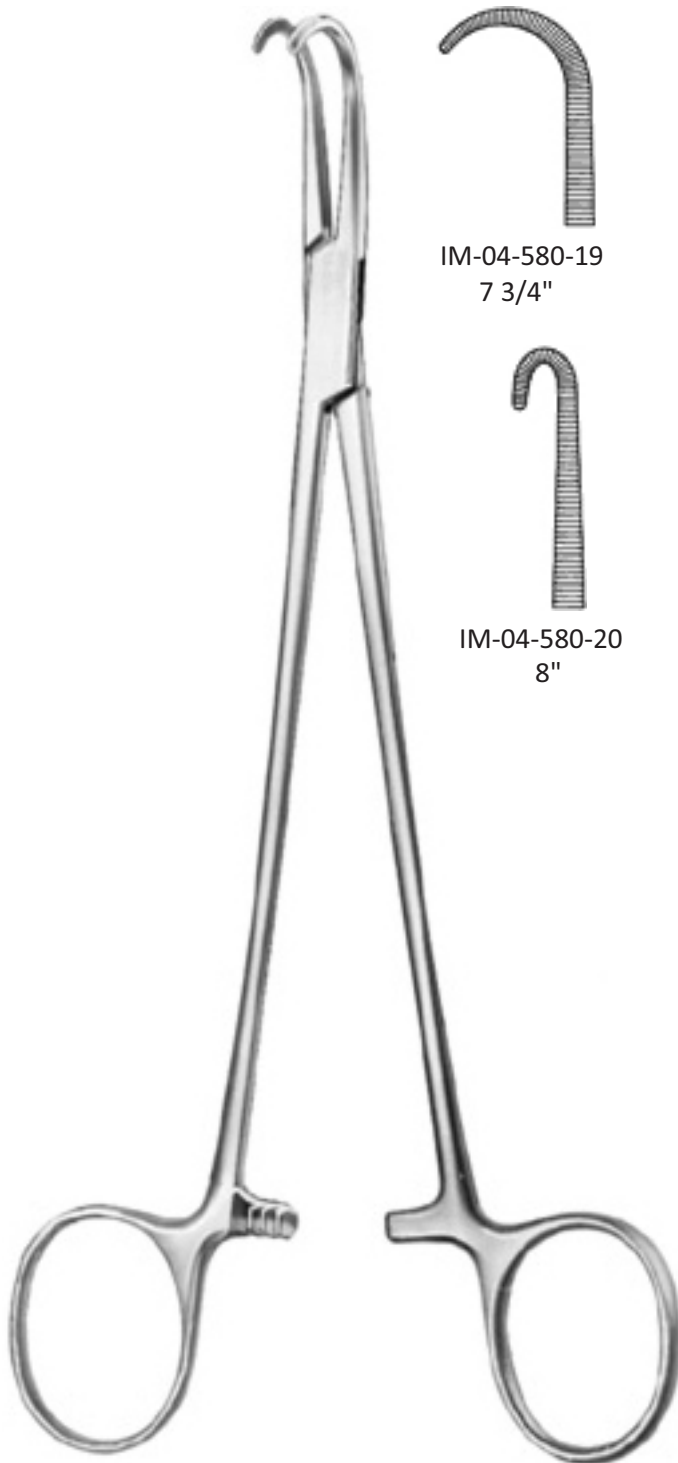

IM-04-580-19
7 3/4"

IM-04-580-20
8"

Haemostatic Forceps
Negus

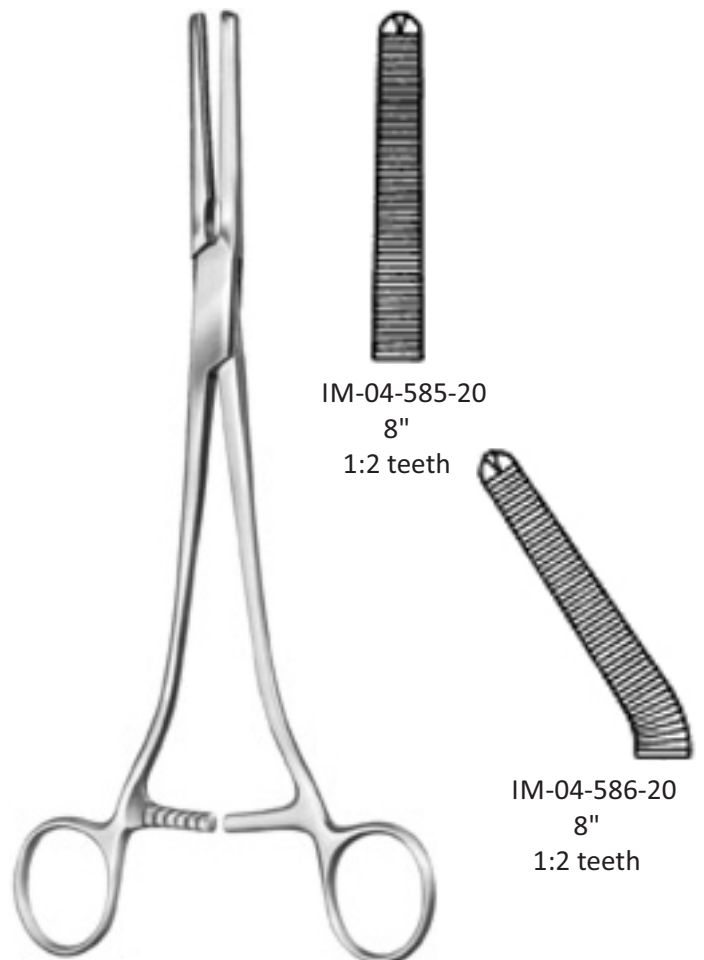

IM-04-585-20
8"
1:2 teeth

IM-04-586-20
8"
1:2 teeth

Hysterectomy Forceps
Phaneuf

Forceps

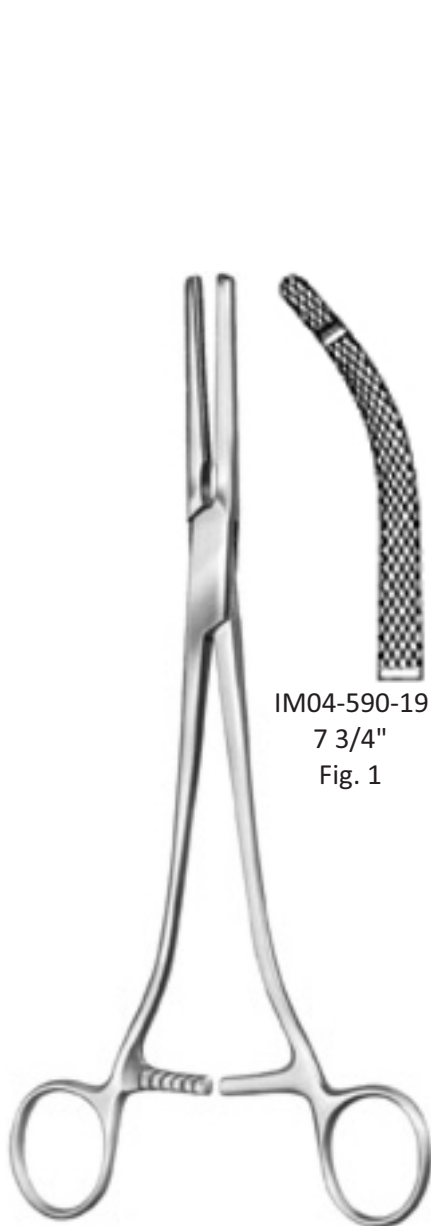

IM04-590-19
7 3/4"
Fig. 1

Hysterectomy Forceps
Heaney

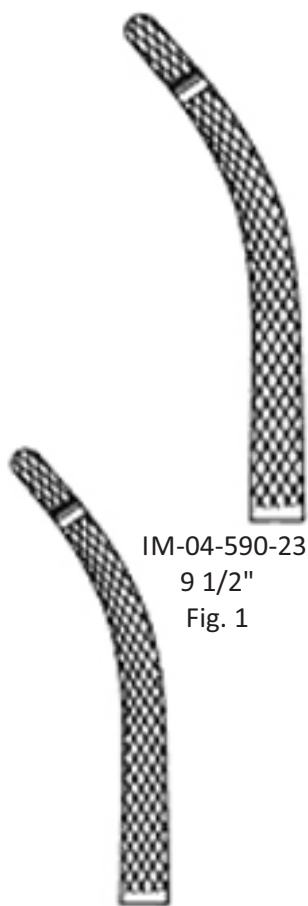

IM-04-590-21
8 1/2"
Fig. 1



IM-04-590-23
9 1/2"
Fig. 1

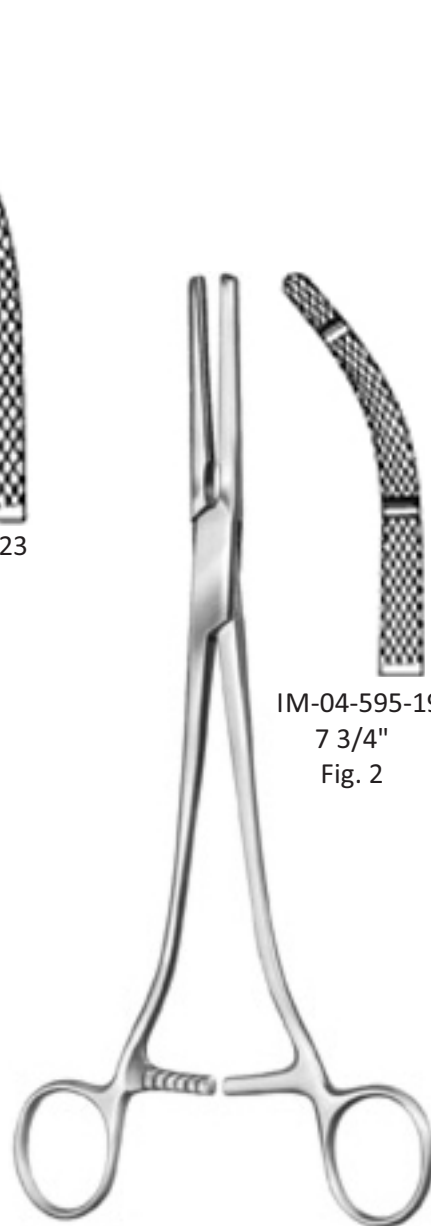

IM-04-595-19
7 3/4"
Fig. 2

Hysterectomy Forceps
Heaney

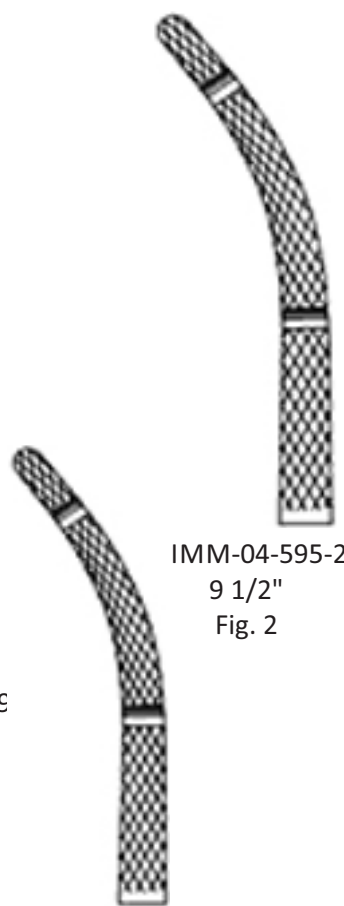

IM-04-595-21
8 1/2"
Fig. 2



IMM-04-595-23
9 1/2"
Fig. 2

Forceps



Vaginal Clamp
Wertheim-Cullen
IM-04-600-21
8 1/4"

Forceps



Hysterectomy Forceps
Rogers



IM-03-605-21
8 1/2"
Fig. 1



IM-03-605-20
8 1/4"
Fig. 2



IM-03-605-20
8"
Fig. 3

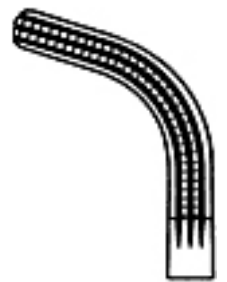

ZI-04-635-40
8"
Fig. 4



IM-03-605-25
10"
Fig. 1



IM-03-605-24
9 3/4"
Fig. 2

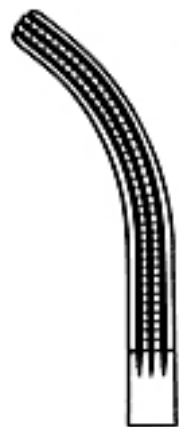

IM-03-605-24
9 3/4"
Fig. 3

Forceps



Hysterectomy Forceps
Moynihan



IM-03-610-23
9"

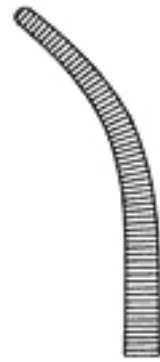

IM-03-610-24
9 1/4"

Forceps



Hysterectomy Forceps
Wertheim
IM-03-615-25
10 1/4"

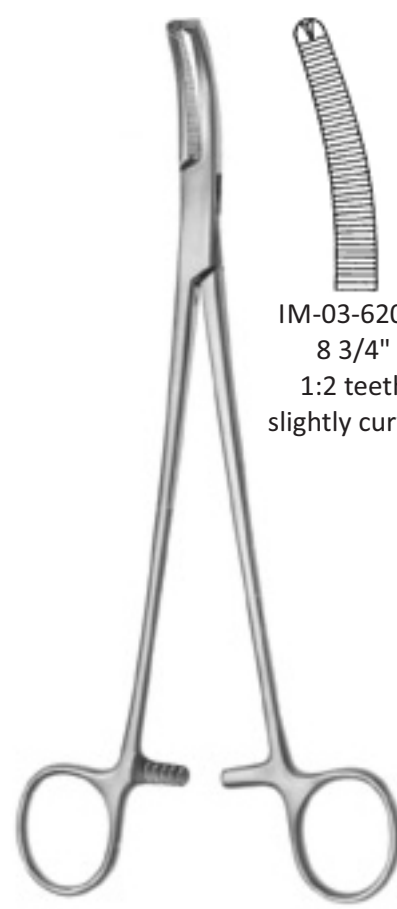

IM-03-620-22
8 3/4"
1:2 teeth
slightly curved

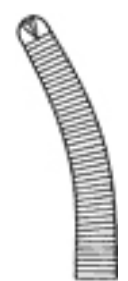

IM-03-620-23
8 3/4"
1:2 teeth
more curved

Forceps

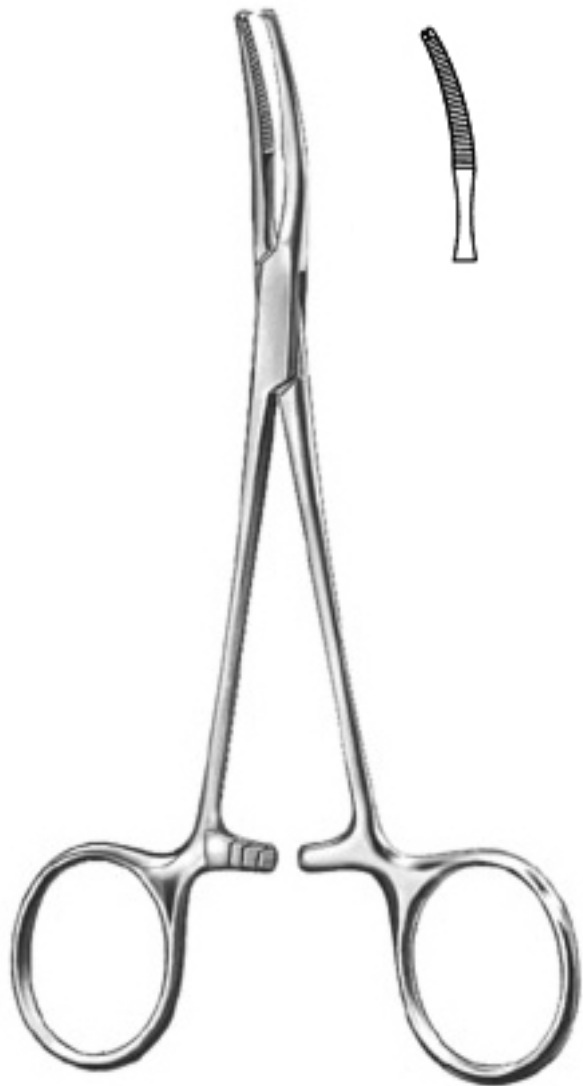

Peritoneum Forceps
Mikulicz, Baby
IM-03-625-14
5 3/4"
1:2 teeth

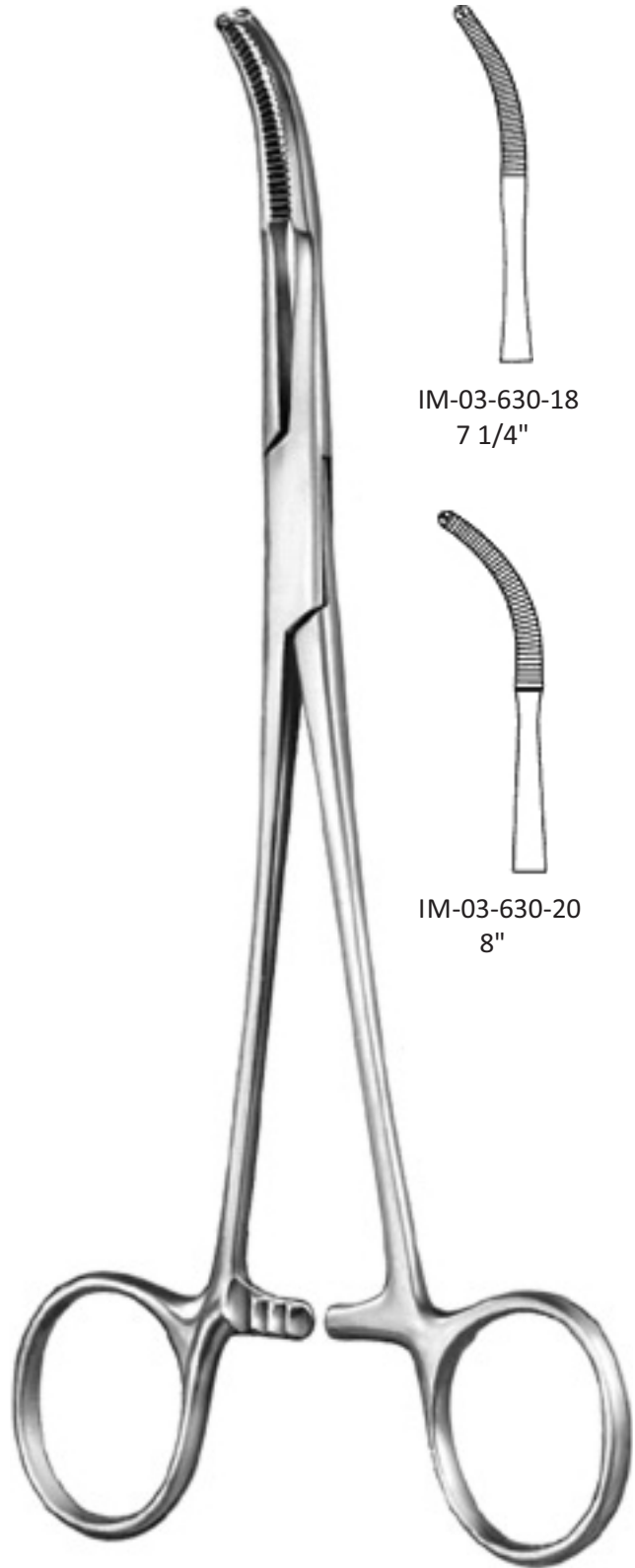

IM-03-630-18
7 1/4"

IM-03-630-20
8"

Peritoneum Forceps
Mikulicz

Forceps



Peritoneum Forceps
Mikulicz
IM-03-636-20
8"



Peritoneum Forceps
Mikulicz
IM-03-638-21
8"

Forceps

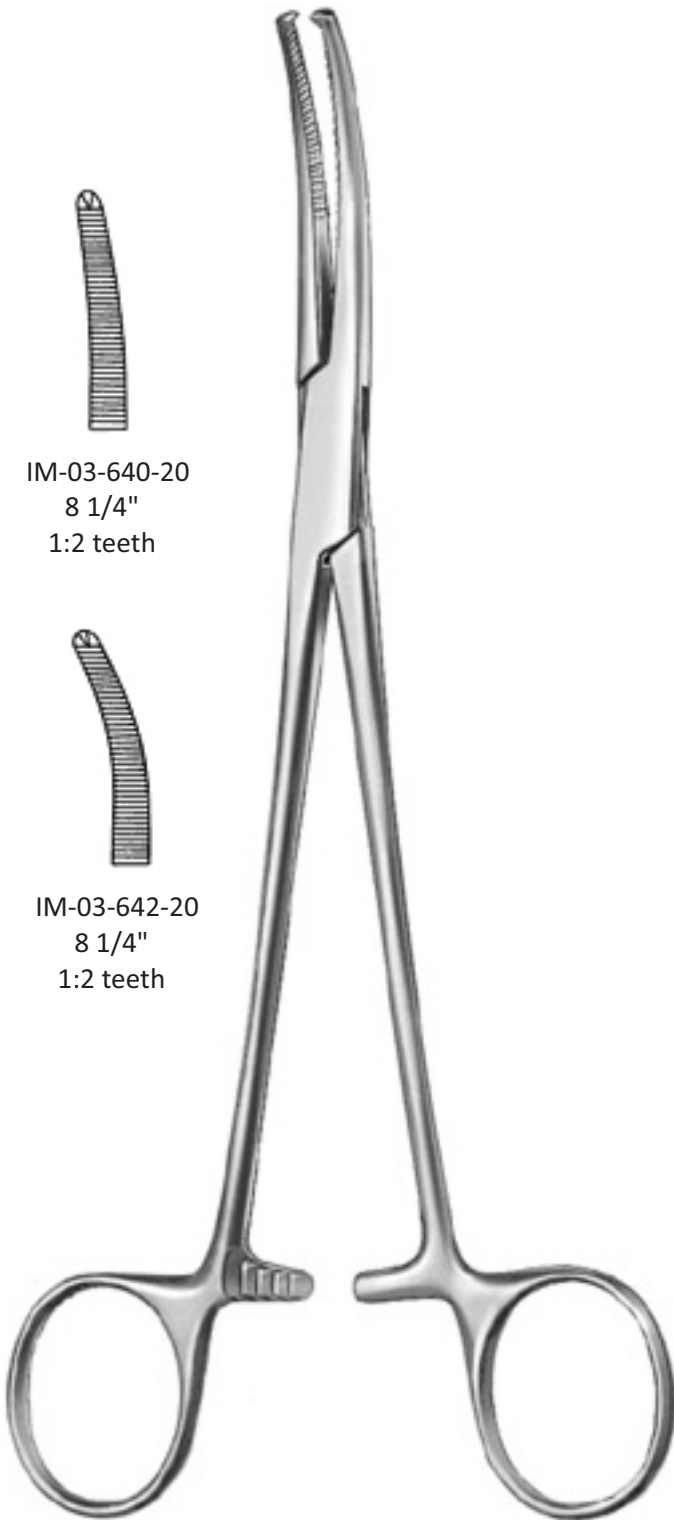

IM-03-640-20
8 1/4"
1:2 teeth

IM-03-642-20
8 1/4"
1:2 teeth

Peritoneum Forceps
Faure



Towel Clamp
Schädel
IM-03-645-09
3 1/2"



Towel Clamp
Jones
IM-03-646-05
2 1/4"



Towel Clamp
Jones
IM-03-648-09
3 1/4"



Towel Clamp
Jones-Martin
IM-03-650-09
3 1/4"

Forceps



Towel Clamp
Backhaus
IMM-03-655-11
4 1/2"

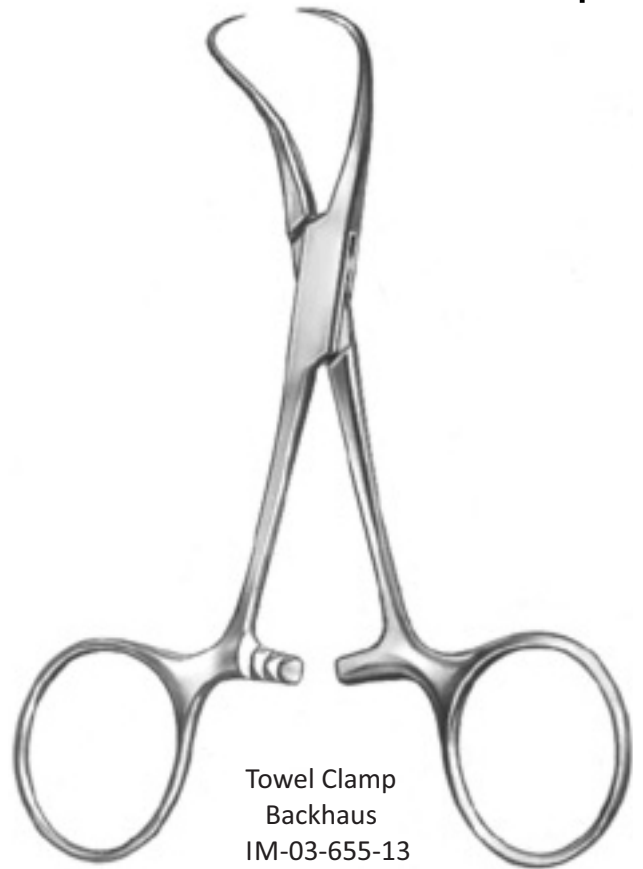

Towel Clamp
Backhaus
IM-03-655-13
5"



Towel Clamp
Backhaus
IM-03-657-11
4 1/2"



Towel Clamp
Backhaus
IM-03-658-08
3 1/2"

Forceps



Towel Clamp
Backhaus
IM-03-660-11
4 1/2"



IM-03-660-13
5"



IM-03-660-15
6 1/4"

Forceps

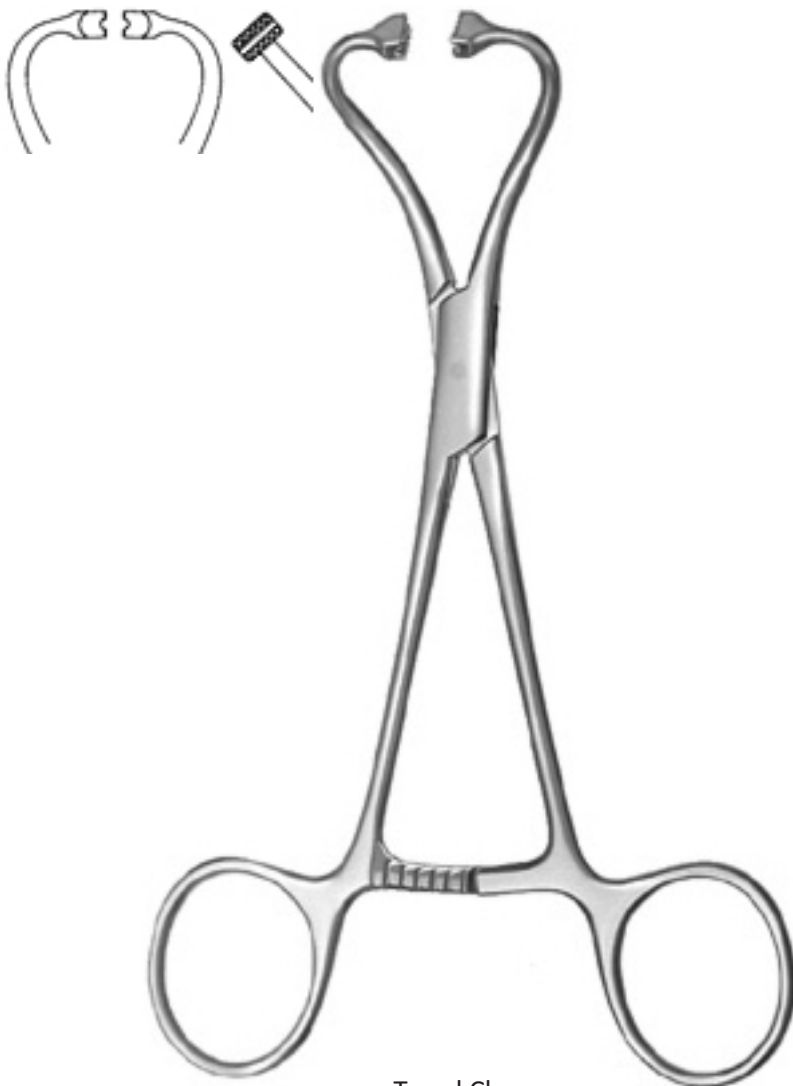

Towel Clamp
Peers-Bertram modif.
IM-03-665-15
6"



Towel Clamp
Röder
IM-03-670-13
5 1/4"

Forceps

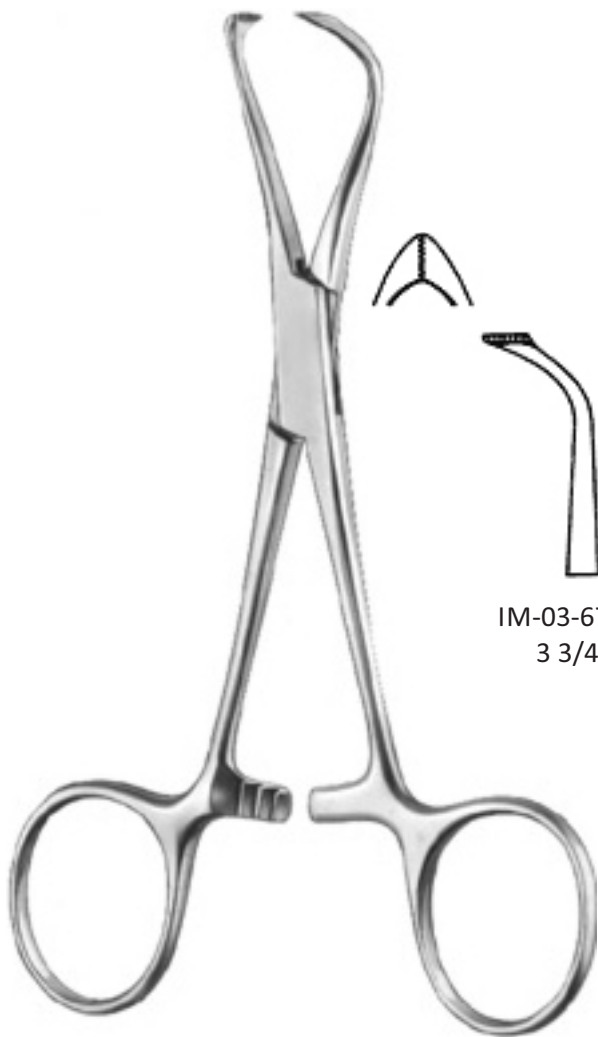

Towel Clamp
Lorna

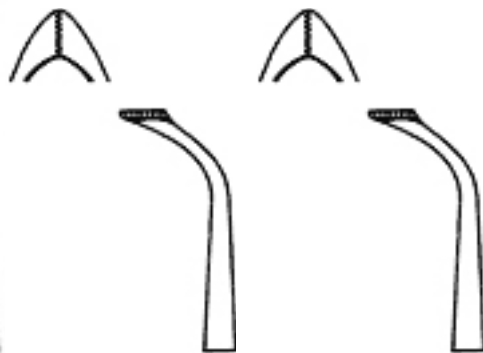

IM-03-675-10
3 3/4"

IMM-03-675-13
5"



Towel Clamp
Bernhard
IM-03-680-16
6 1/2"

Forceps

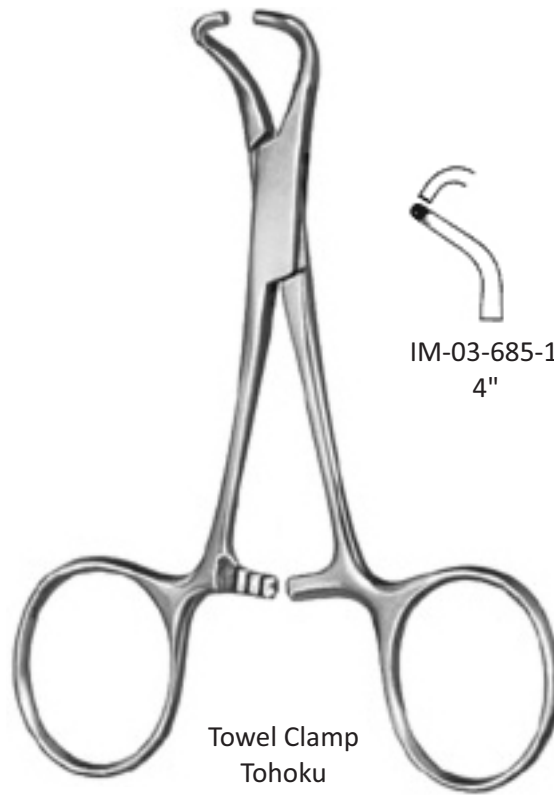

Towel Clamp
Tohoku



IM-03-685-10
4"



IM-03-685-13
5 1/4"

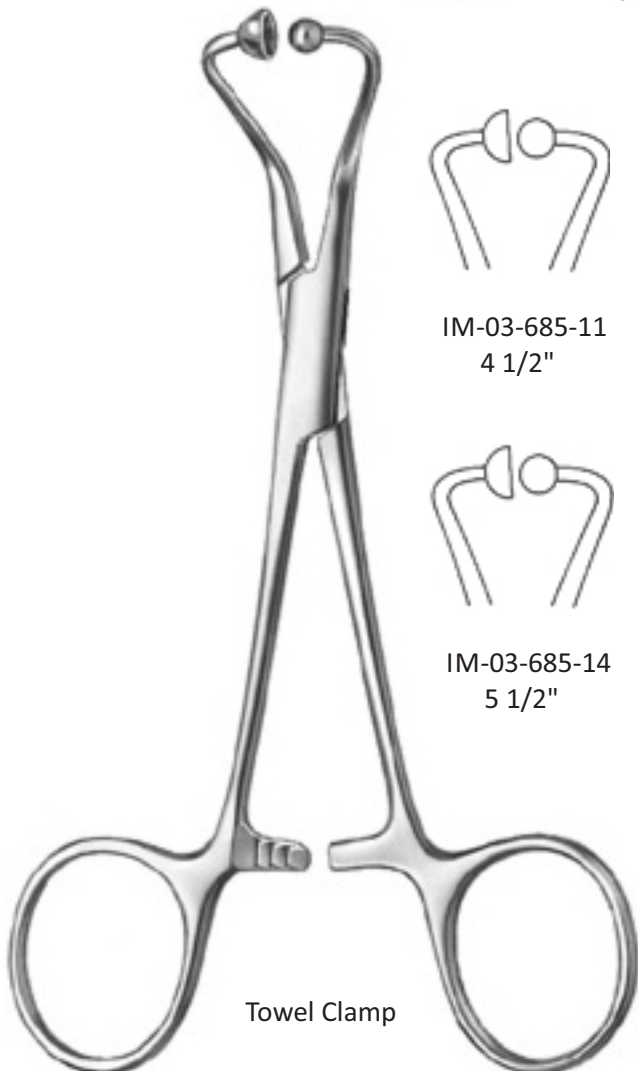

Towel Clamp



IM-03-685-11
4 1/2"



IM-03-685-14
5 1/2"

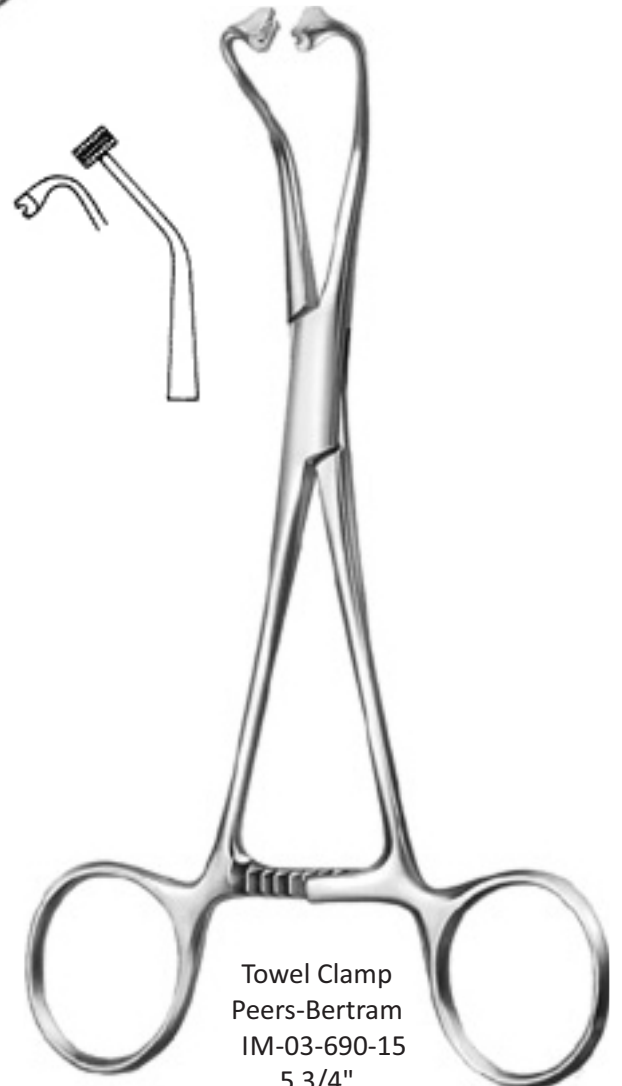

Towel Clamp
Peers-Bertram
IM-03-690-15
5 3/4"

Forceps



Towel Clamp
Lane
IM-03-695-20
7 3/4"

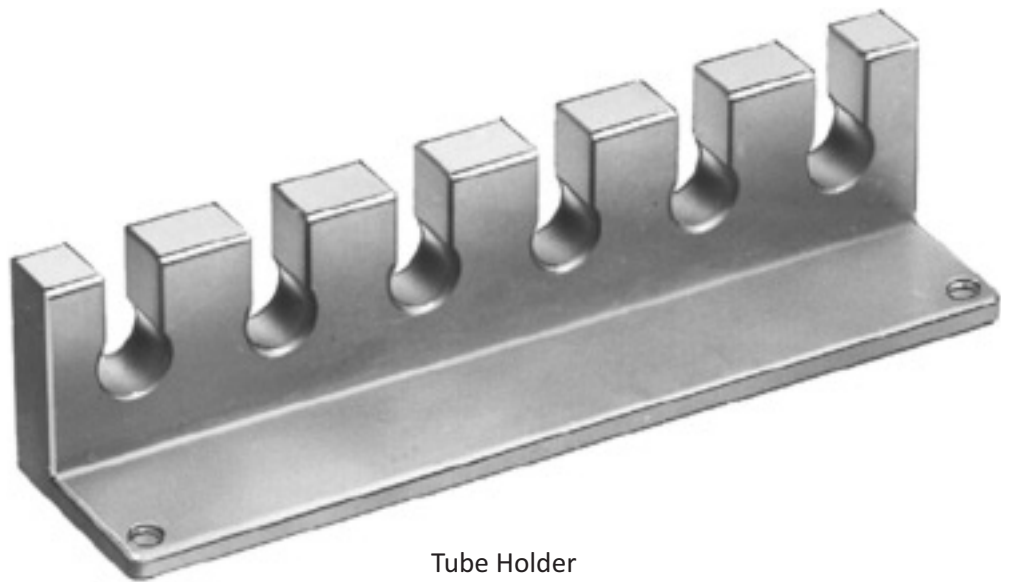

Tube Holder
IM-03-700-06

Forceps



Tubing Clamp
IM-03-705-14
5 1/2"



Tubing Clamp
IM-03-705-16
6 1/2"

Forceps



Tubing Clamp



IM-03-710-15
6"



IM-03-710-18
7 1/2"



IM-03-710-20
8"

Forceps

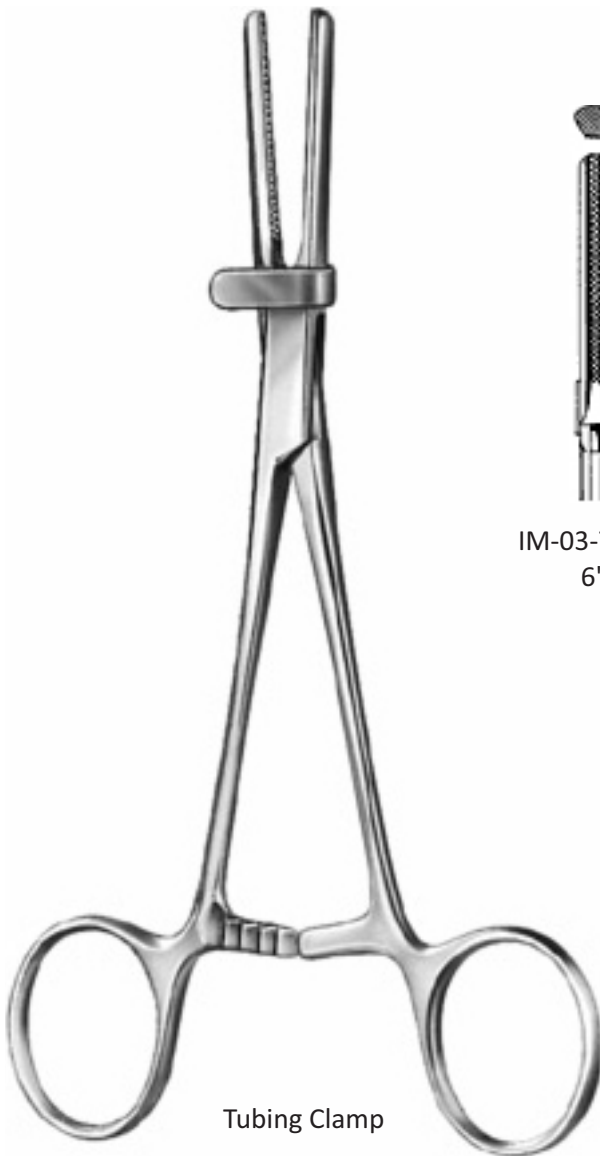

Tubing Clamp



IM-03-715-15
6"



IM-03-715-18
7 1/2"



IM-03-715-20
8"

Forceps



IM-03-720-22
8 3/4"

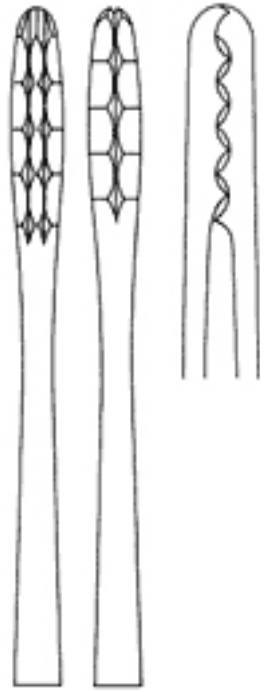

IM-03-720-27
10 1/2"



Dressing Forceps
Ulrich



IM-03-722-22
8 3/4"



IM-03-722-27
10 1/2"

Forceps



Sinus Forceps
Lister

IM-03-725-13
5"



IM-03-727-13
5"



IM-03-729-13
5"



Dressing Forceps
Martin

IM-03-730-17
7"



I-03-732-17
7"

Forceps



Dressing Forceps
Gross-Maier



IM-03-735-20
8"



IM-03-735-22
8 3/4"



IM-03-735-27
10 1/2"



IM-03-737-20
8"



IM-03-737-22
8 1/2"



IM-03-737-27
10 1/4"

Forceps



Tunneling Forceps
IM-03-740-40
15 1/2"

Forceps

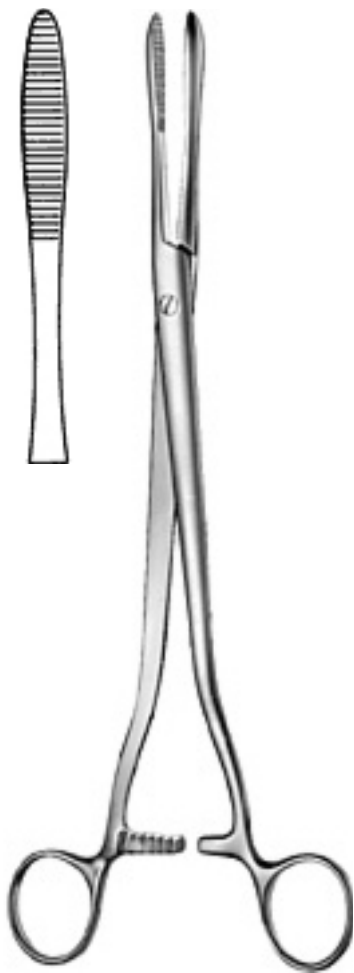

Dressing Forceps
Collin
IM-03-745-25
10"



Dressing Forceps
Cheron
IM-03-747-25
9 1/4"

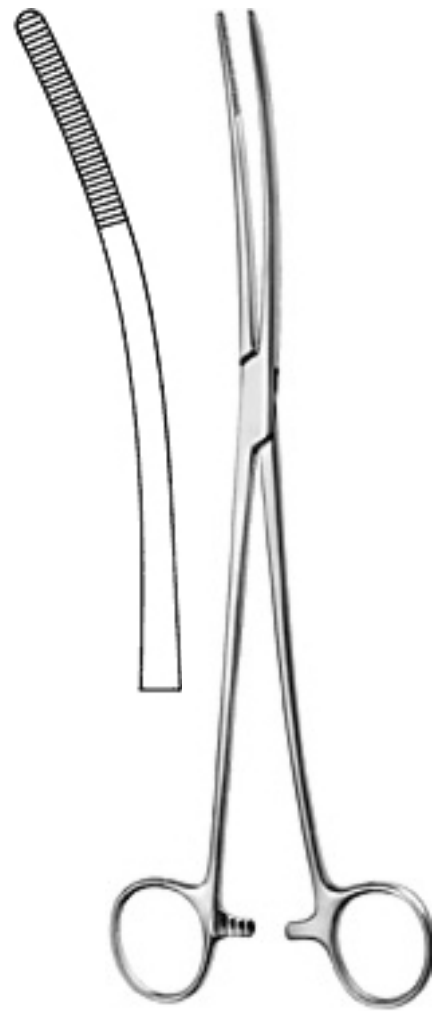

Sponge Forceps
Bozemann
IM-03-749-26
10 1/4"

Forceps



IM-03-750-25
9 3/4"



IM-03-752-18
7"



IM-03-752-20
8"



IM-03-752-25
9 3/4"



Sponge Forceps
Foerster



IM-03-755-25
9 3/4"



IM-03-756-18
7"

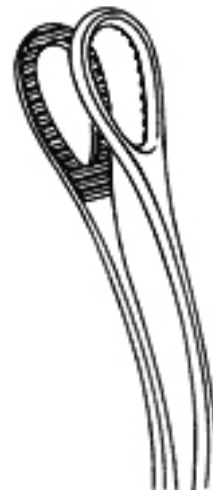

IM-03-756-20
8"



IM-03-756-25
9 3/4"

Forceps



Sponge Forceps
Foerster



IM-03-760-25
9 3/4"

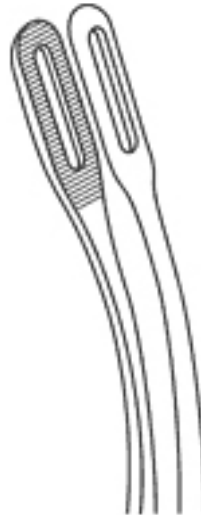

IM-03-762-25
9 3/4"



Sponge Forceps
Rampley



IM-03-765-18
7 1/4"



IM-03-765-25
9 3/4"

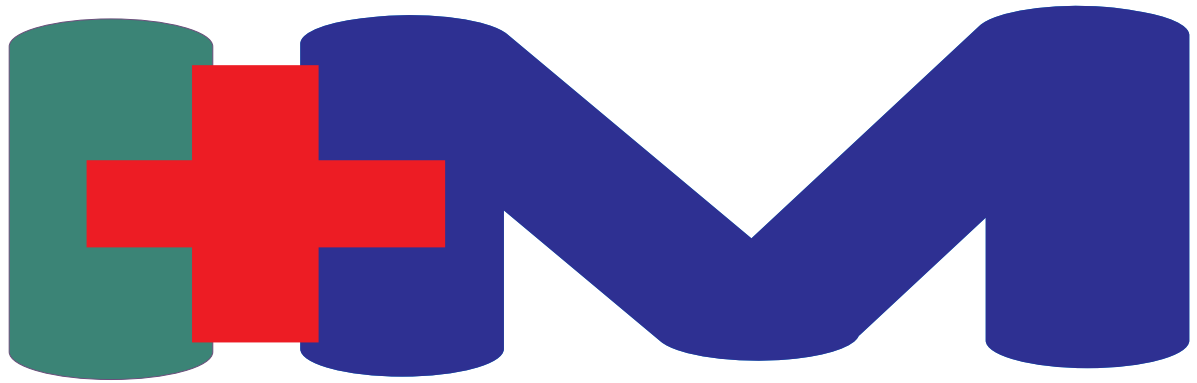

IBRAHIM MEDS

I N S T R U M E N T S

 77 A Model Town Ugoki Sialkot

 +92 52 3512235

 +92 52 4007564

 +92 300 7163508 , +92 307 6427547

 info@ibrahimmeds.com

 amjad@ibrahimmeds.com

 www.ibrahimmeds.com