

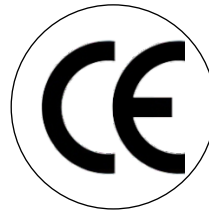

WE SERVE HUMANITY WITH EXCELLENCE

IBRAHIM MEDS



4-RETRACTOR

Retractor



Skin Hook



IM-04-001-01
6 1/4"
Fig. 1



IM-04-001-02
6 1/4"
Fig. 2



IM-04-001-03
6 1/4"
Fig. 3



IM-04-001-04
6 1/4"
Fig. 4

Retractor

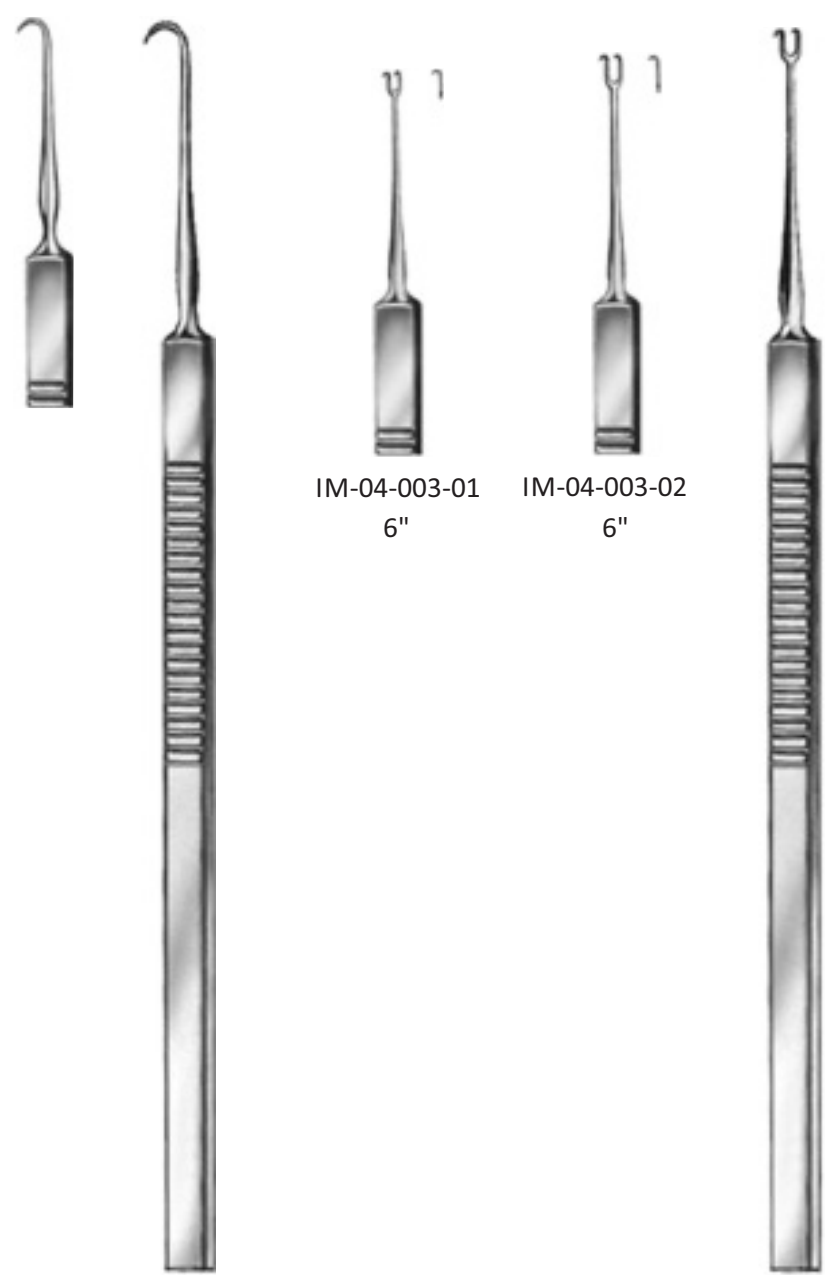

Skin Hook
O'Connor
IM-04-002-16
6 1/4"

IM-04-003-01
6"

IM-04-003-02
6"

Skin Hook
Guthrie

Retractor

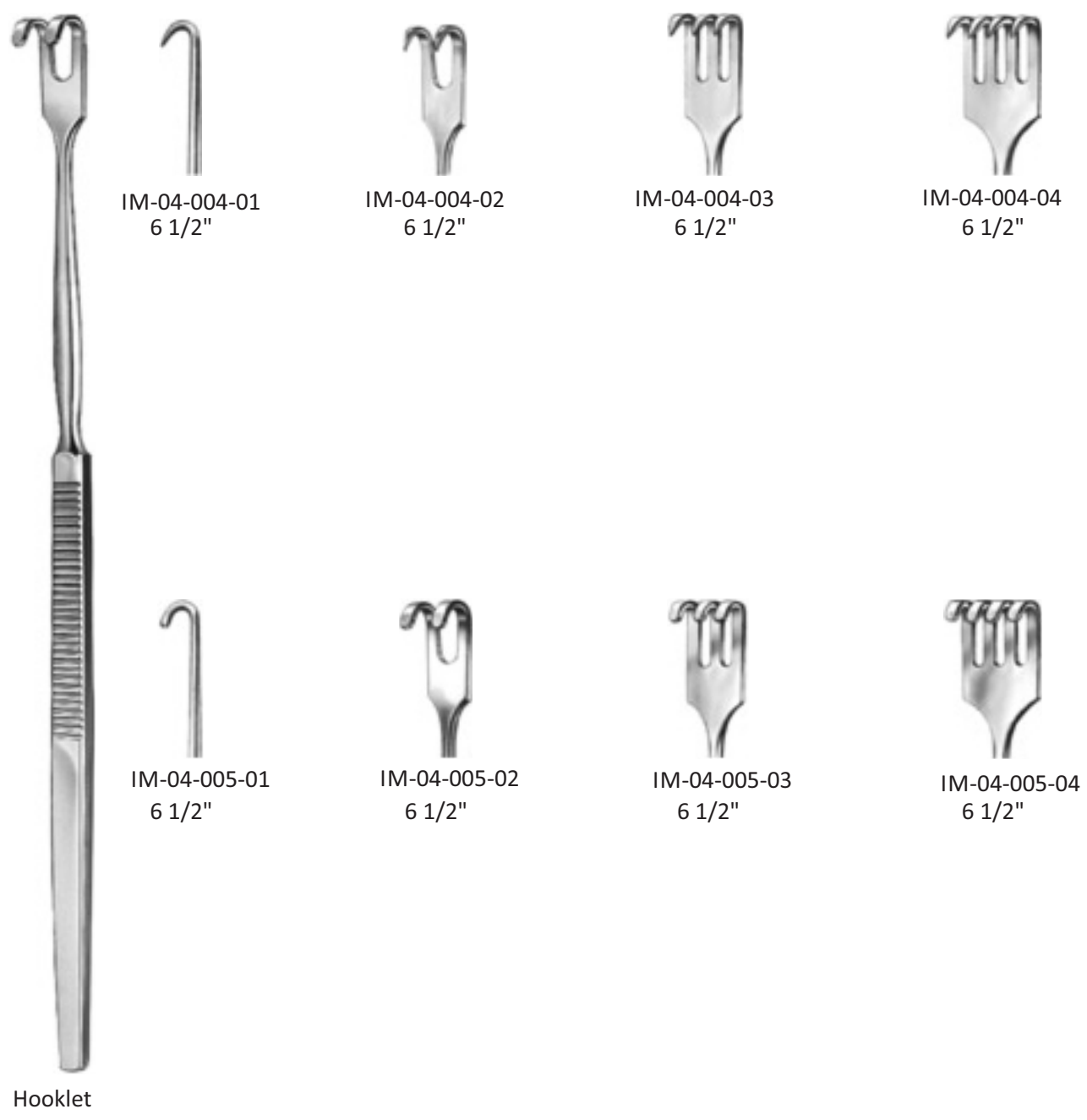

Retractor



Hooklet

- IM-04-007-02
6 1/4"
sharp
- IM-04-007-03
6 1/4"
sharp
- IM-04-007-04
6 1/4"
sharp

- IM-04-006-02
6 1/4"
blunt
- IM-04-006-03
6 1/4"
blunt
- IM-04-006-04
6 1/4"
blunt



Hooklet

- IM-04-008-04S
6 1/2"
sharp
- IM-04-008-04B
6 1/2"
blunt

Retractor

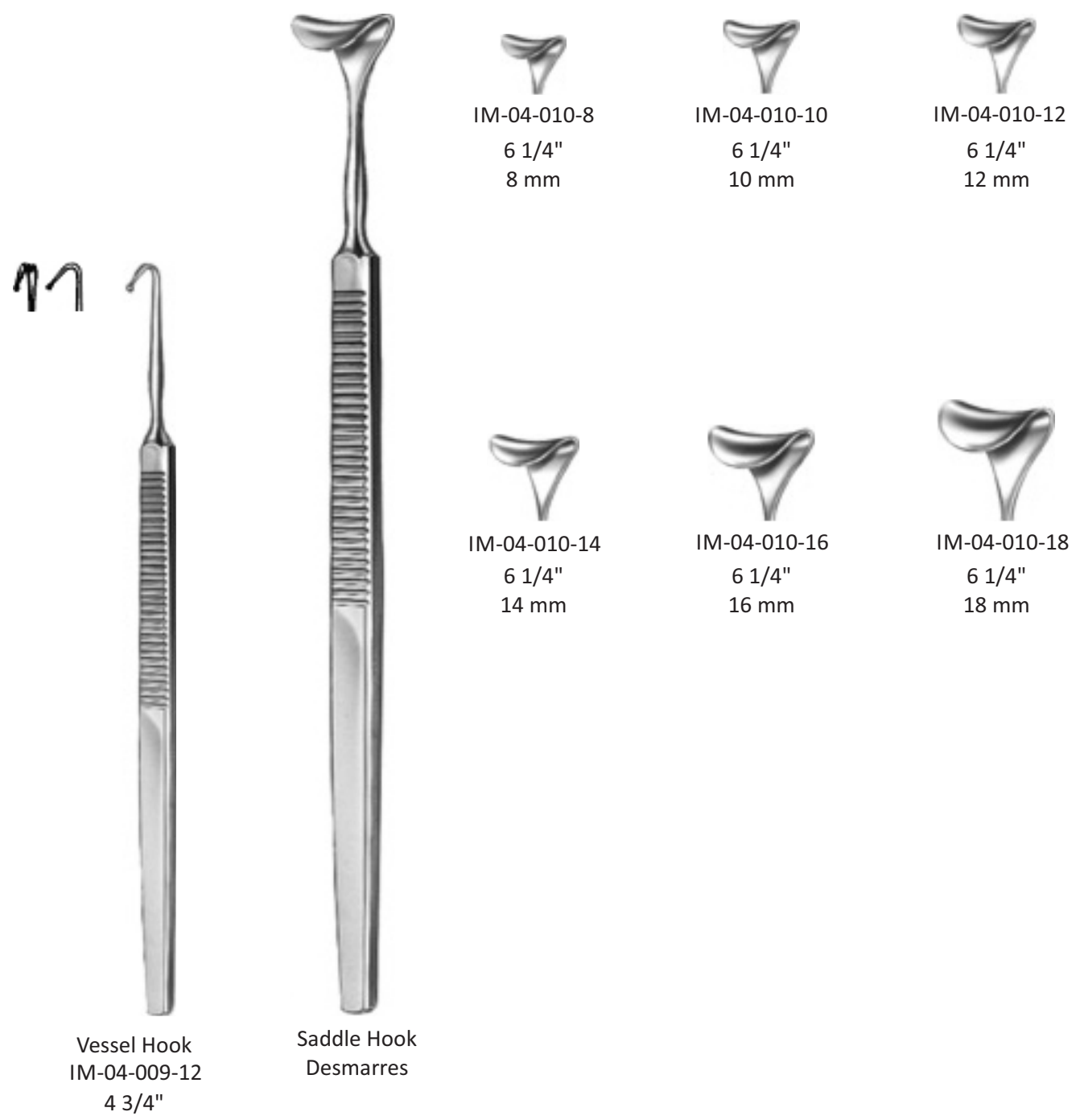

Retractor



Saddle Hook

IM-04-011-12
6 1/4"
12 mm

IM-04-011-16
6 1/4"
16 mm

IM-04-011-14
6 1/4"
14 mm

IM-04-011-18
6 1/4"
18 mm



Hooklet



Langenbeck-Mini
IM-04-011-10
6 1/4"
10 x 6 mm



Langenbeck-Mini
IM-04-011-17
6 1/4"
17 x 5 mm



Langenbeck-Mini
IM-04-011-20
6 1/4"
20 x 6 mm



Langenbeck-Mini
IM-04-011-22
6 1/4"
22 x 8 mm

Retractor

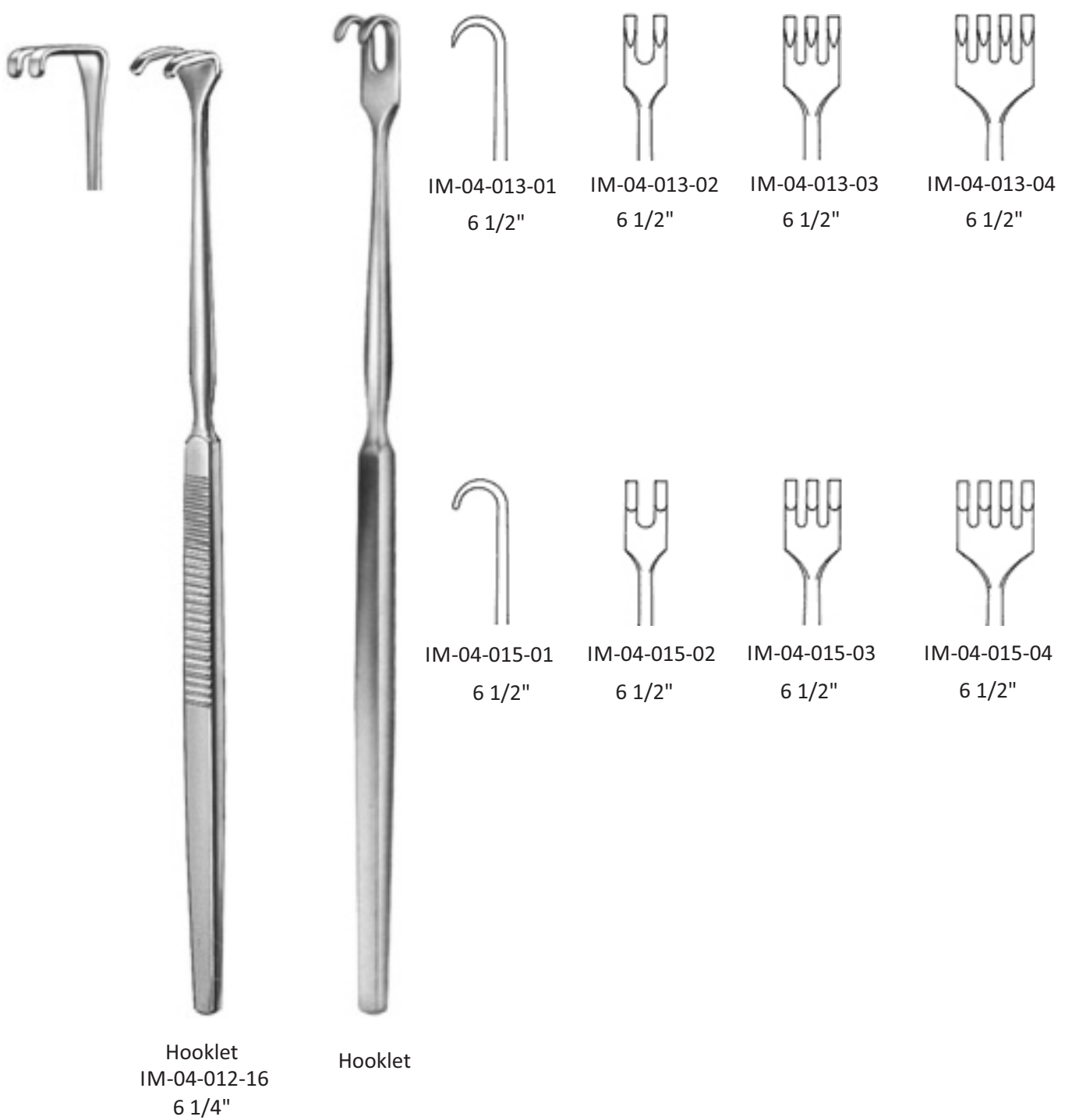

Retractor



Hooklet
Meyerding



IM-04-016-01
7"
Fig. 118 x 7 mm
blunt



IM-04-016-02
7"
Fig. 216 x 5 mm
toothed



IM-04-016-03
7"
Fig. 37 x 4 mm
toothed



IM-04-017-04
7"
Fig. 410 x 3 mm
blunt



IM-04-017-05
7"
Fig. 57 x 4 mm
saddle shaped



IM-04-017-06
7"
Fig. 610 x 4 mm
sharp

Retractor

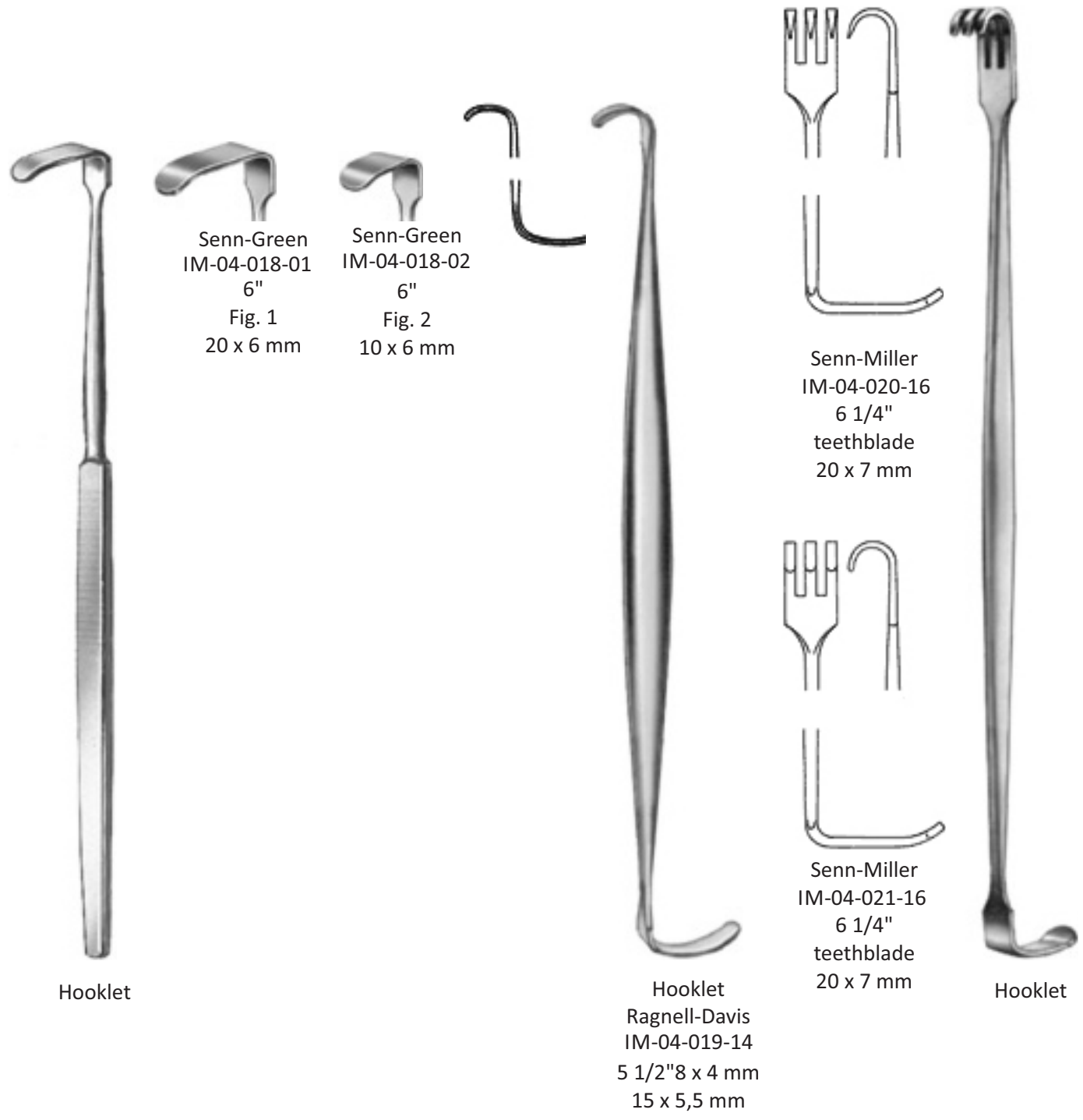

Retractor

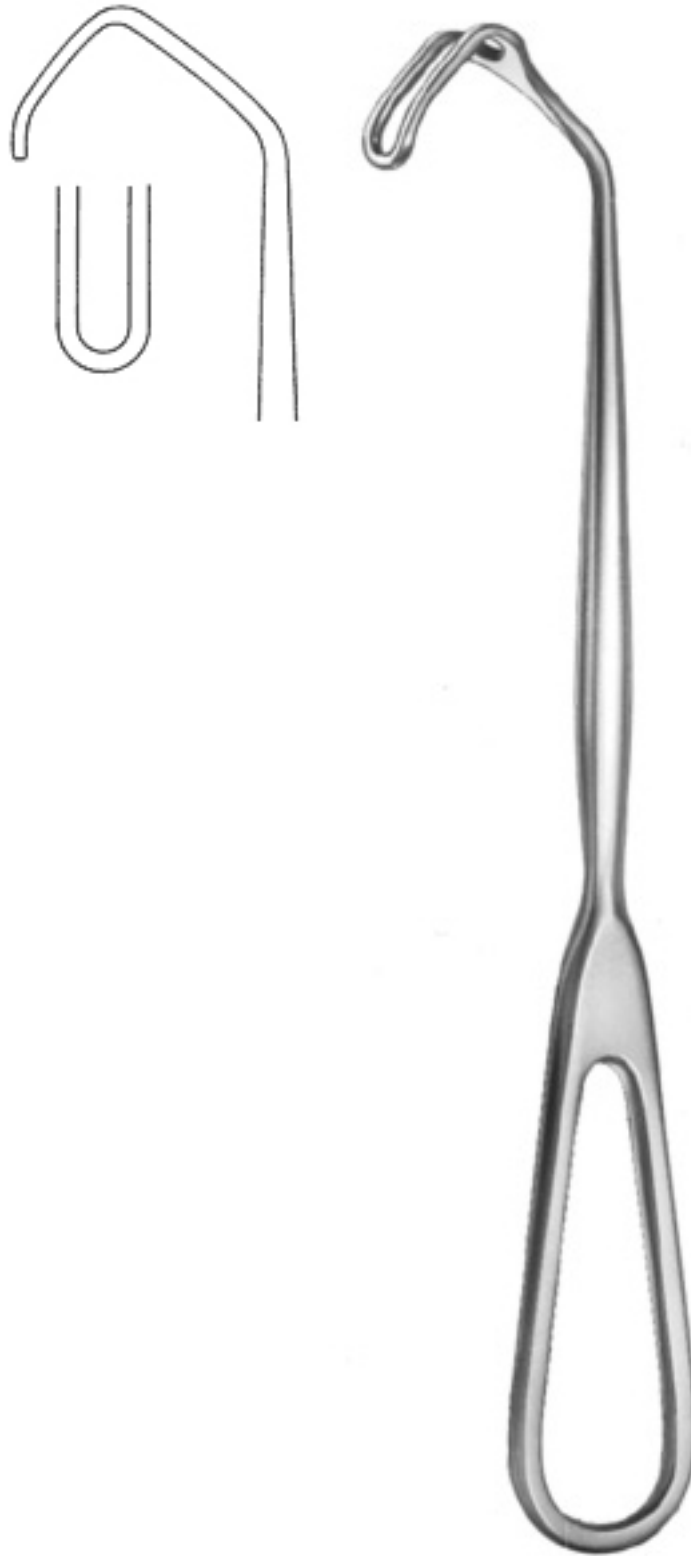

Retractor
Cushing
IM-04-022-20
8"

Retractor



Saddle Hook
Cushing



IM-04-023-08
8"
8 mm wide



IM-04-023-08
8"
10 mm wide



IM-04-023-08
8"
12 mm wide



IM-04-023-08
8"
14 mm wide



IM-04-023-08
8"
16 mm wide



IM-04-023-08
8"
18 mm wide

Retractor

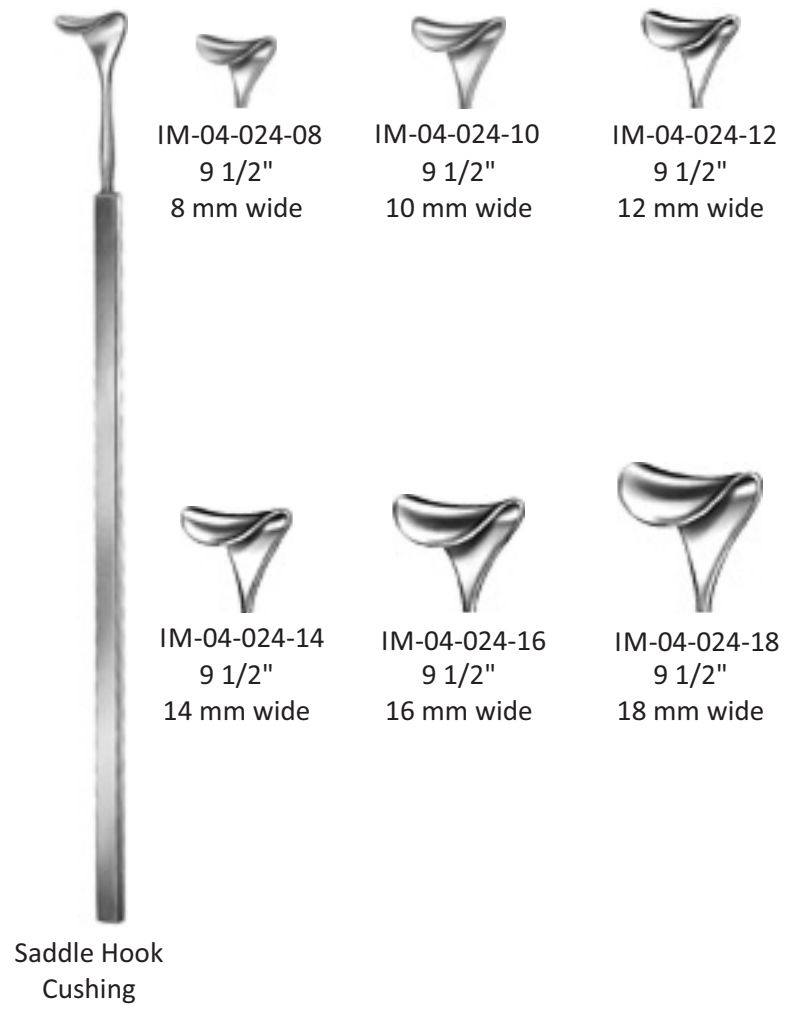

Retractor



Saddle Hook
Gil-Vernet



IM-04-025-08
9 1/2"
8 mm wide



IM-04-025-11
9 1/2"
11 mm wide



IM-04-025-15
9 1/2"
15 mm wide



IM-04-025-17
9 1/2"
17 mm wide



IM-04-025-20
9 1/2"
20 mm wide



IM-04-025-23
9 1/2"
23 mm wide

Retractor



Retractor
Klapp



IM-04-026-01
7"
12 x 6 mm



IM-04-026-02
7"
12 x 11 mm



IM-04-026-03
7"
15 x 11 mm

Retractor



Hooklet



IM-04-027-04
6 1/2"
sharp



IM-04-028-04
6 1/2"
blunt

Retractor

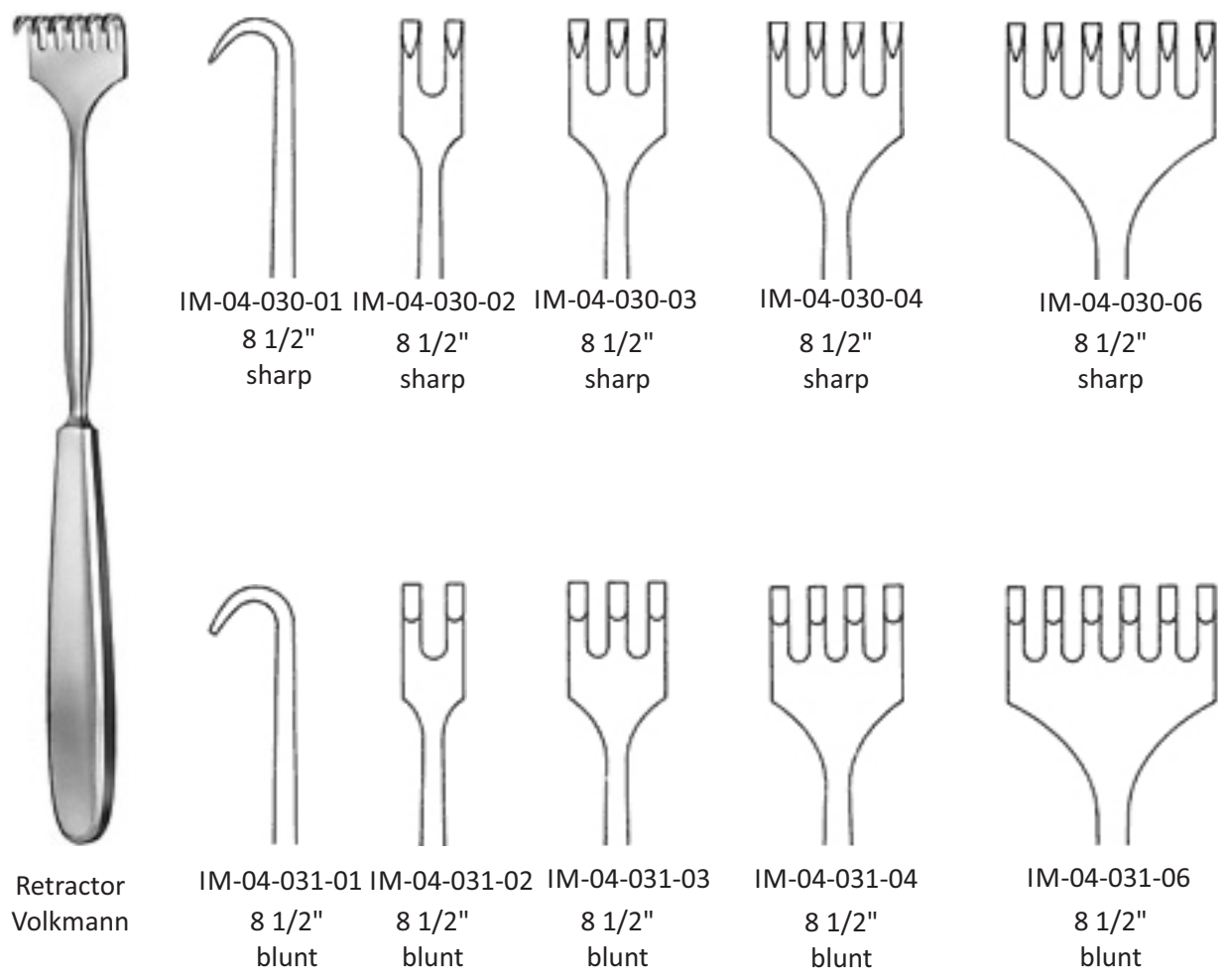

Retractor
Volkmann

Retractor



Retractor
Volkmann



IM-04-032-01
8 3/4"
sharp



IM-04-032-02
8 3/4"
sharp



IM-04-032-03
8 3/4"
sharp



IM-04-032-04
8 3/4"
sharp

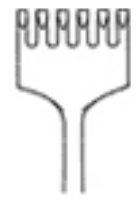

IM-04-030-06
8 3/4"
sharp



IM-04-033-01
8 3/4"
blunt



IM-04-033-02
8 3/4"
blunt



IM-04-033-03
8 3/4"
blunt



IM-04-033-04
8 3/4"
blunt

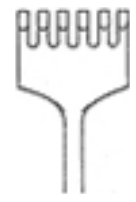

IM-04-033-06
8 3/4"
blunt



IM-04-034-01
8 3/4"
semi-sharp



IM-04-034-02
8 3/4"
semi-sharp



IM-04-034-03
8 3/4"
semi-sharp



IM-04-034-04
8 3/4"
semi-sharp



IM-04-034-06
8 3/4"
semi-sharp

Retractor



Retractor
Volkmann

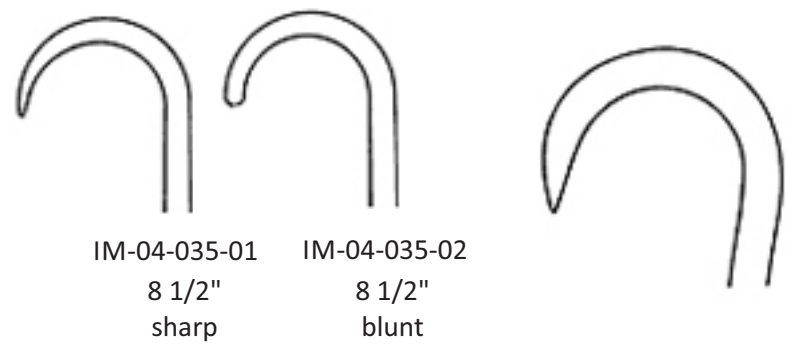

Retractor
Volkmann
IM-04-036-01
8 1/2"
sharp

Retractor









Retractor
Kocher

IM-04-037-01 8 3/4" sharp	IM-04-037-02 8 3/4" sharp	IM-04-037-03 8 3/4" sharp	IM-04-037-04 8 3/4" sharp	IM-04-037-05 8 3/4" sharp	IM-04-037-06 8 3/4" sharp
IM-04-038-01 8 3/4" blunt	IM-04-038-02 8 3/4" blunt	IM-04-038-03 8 3/4" blunt	IM-04-038-04 8 3/4" blunt	IM-04-038-05 8 3/4" blunt	IM-04-038-06 8 3/4" blunt
IM-04-039-01 8 3/4" semi-sharp	IM-04-039-02 8 3/4" semi-sharp	IM-04-039-03 8 3/4" semi-sharp	IM-04-039-04 8 3/4" semi-sharp	IM-04-039-05 8 3/4" semi-sharp	IM-04-039-06 8 3/4" semi-sharp

Retractor

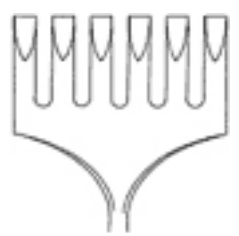

Retractor
Martin

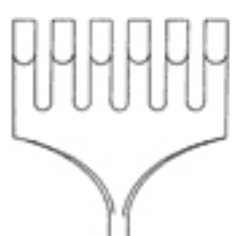
			
IM-04-040-02 8 3/4" sharp	IM-04-040-03 8 3/4" sharp	IM-04-040-04 8 3/4" sharp	IM-04-040-06 8 3/4" sharp
			
IM-04-041-02 8 3/4" blunt	IM-04-041-03 8 3/4" blunt	IM-04-041-04 8 3/4" blunt	IM-04-041-06 8 3/4" blunt

Retractor



Retractor
Ollier



IM-04-042-03
9"
36 x 30 mm

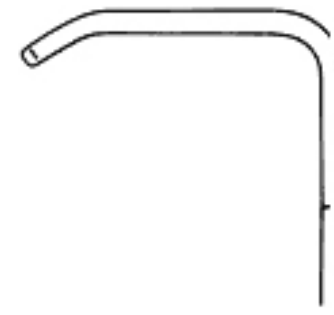

IM-04-042-04
9"
36 x 60 mm

Retractor

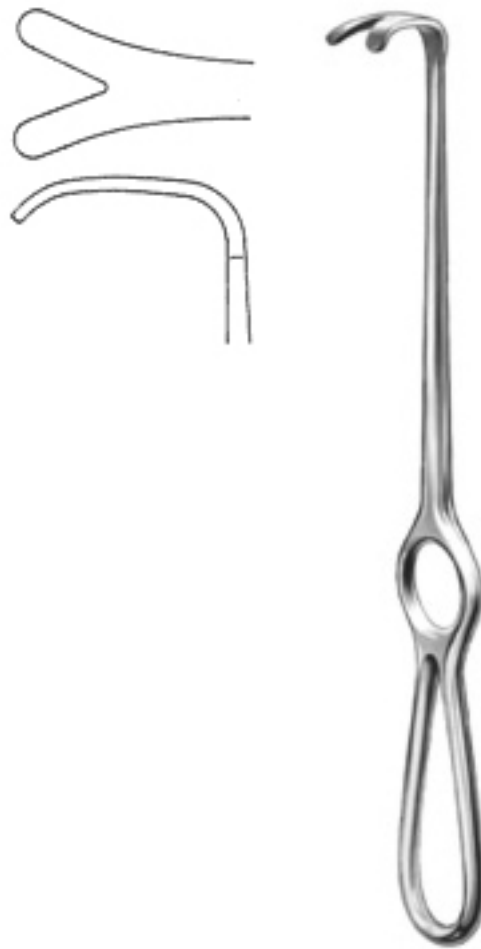

Retractor
Wassmund
IM-04-043-02
8"33 x 21 mm

Retractor



Retractor
Israel



IM-04-044-04
10"
40 x 40 mm



IM-04-044-05
10"
45 x 50 mm



IM-04-045-06
10"
50 x 60 mm



IM-04-045-07
10"
70 x 70 mm

Retractor



Retractor
Körte



IM-04-046-08
9 3/4"
40 x 30 mm
sharp



IM-04-047-08
9 3/4"
40 x 30 mm
blunt

Retractor



Retractor
Langenbeck



IM-04-048-01
8 3/4"
30 x 11 mm

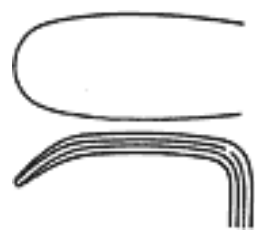

IM-04-048-02
8 3/4"
30 x 14 mm



IM-04-048-03
8 3/4"
30 x 16 mm



IM-04-048-04
8 3/4"
40 x 11 mm



IM-04-048-05
8 3/4"
50 x 11 mm

Retractor



Retractor
Langenbeck



IM-04-049-01
8 3/4"
30 x 11 mm



IM-04-049-02
8 3/4"
30 x 14 mm



IM-04-049-03
8 3/4"
30 x 16 mm



IM-04-049-04
8 3/4"
40 x 11 mm



IM-04-049-05
8 3/4"
50 x 11 mm

Retractor

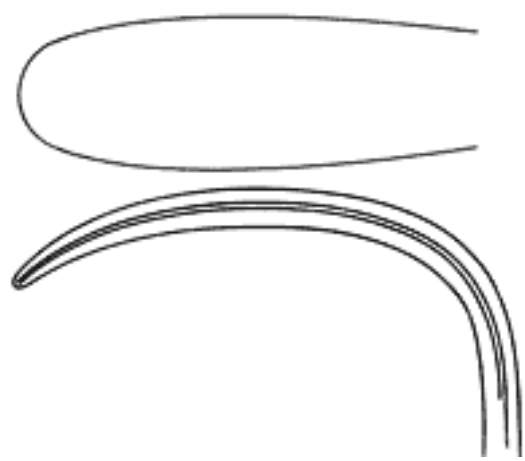

Retractor
Langenbeck
IM-04-050-21
8 1/4"

Retractor



Retractor
Langenbeck
IM-04-051-21
8 3/4"
85 x 15 mm

Retractor

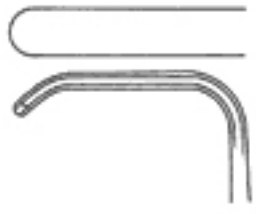

Retractor
Lahey
IM-04-052-19
7 3/4"
31 x 6 mm



Retractor
Little
IM-04-052-20
8"
13 x 15 mm

Retractor

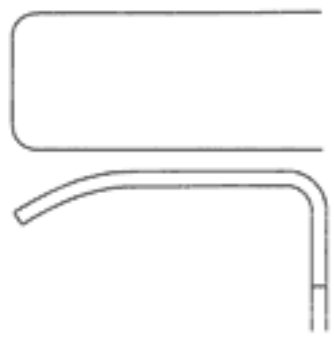

IM-04-053-18
9"
43 x 18 mm



IM-04-053-20
9"
53 x 20 mm



IM-04-053-25
9"
63 x 25 mm



IM-04-053-30
9"
77 x 30 mm



IM-04-053-40
9"
78 x 40 mm



Retractor
Kocher

Retractor



IM-04-054-01
8 1/2"
25 x 6 mm



IM-04-054-02
8 1/2"
35 x 8 mm



IM-04-054-03
8 1/2"
35 x 11 mm



IM-04-054-04
8 1/2"
35 x 15 mm



IM-04-054-05
8 1/2"
40 x 11 mm



Retractor
Kocher-Langenbeck



IM-04-054-06
8 1/2"
55 x 11 mm



IM-04-054-07
8 1/2"
70 x 14 mm



IM-04-054-08
8 1/2"
80 x 12 mm



IM-04-054-09
8 1/2"
80 x 16 mm

Retractor



Retractor
Kocher-Langenbeck



IM-04-055-01
8 1/2"
25 x 10 mm



IM-04-055-02
8 1/2"
40 x 13 mm



IM-04-055-03
8 1/2"
60 x 13 mm



IM-04-055-04
8 1/2"
40 x 18 mm



IM-04-055-05
8 1/2"
60 x 18 mm



IM-04-055-06
8 1/2"
85 x 18 mm



IM-04-055-07
8 1/2"
60 x 25 mm



IM-04-055-08
8 1/2"
85 x 25 mm

Retractor



Retractor
Zenker



IM-04-056-01
9 3/4"
35 x 8 mm

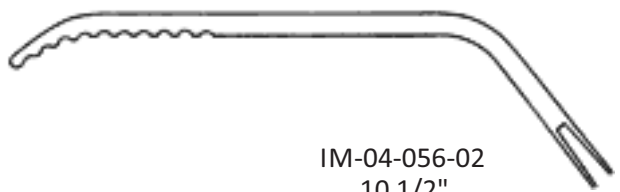

IM-04-056-02
10 1/2"
60 x 12 mm

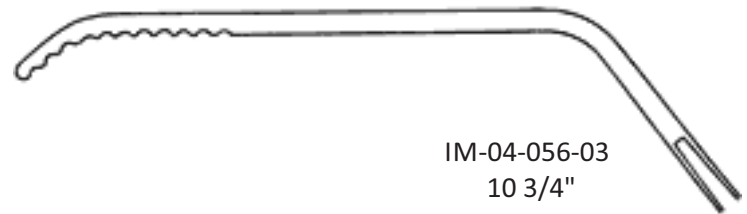

IM-04-056-03
10 3/4"
75 x 12 mm



IM-04-056-04
11 1/4"
85 x 20 mm



IM-04-056-05
12"
100 x 25 mm

Retractor

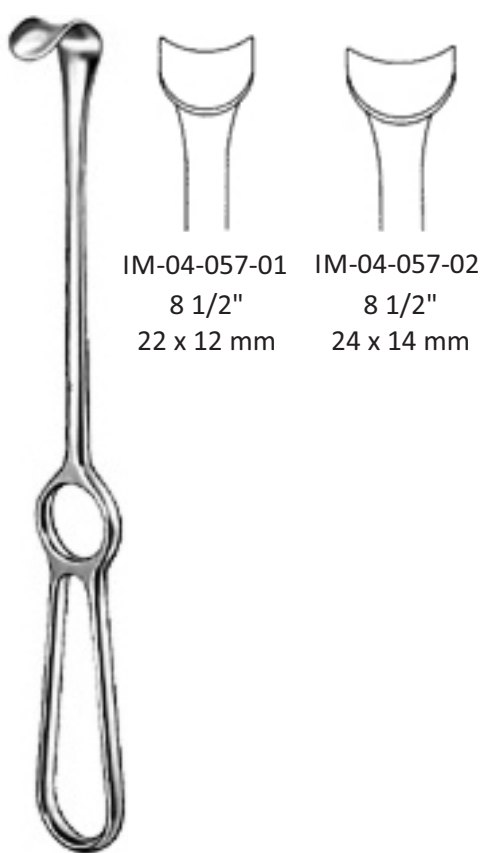

IM-04-057-01
8 1/2"
22 x 12 mm

IM-04-057-02
8 1/2"
24 x 14 mm

Retractor
Kocher

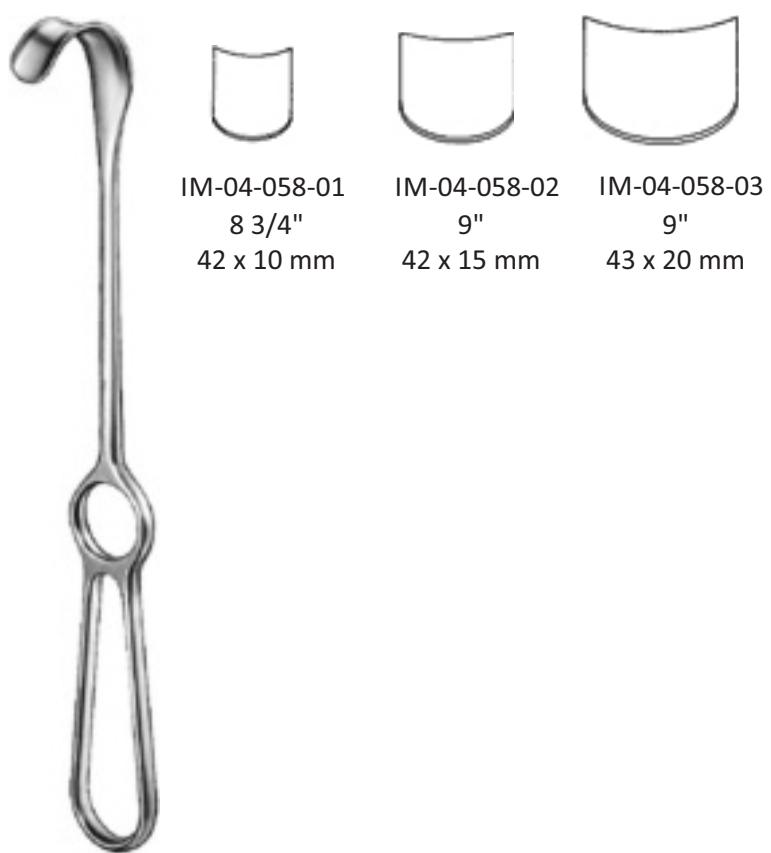

IM-04-058-01
8 3/4"
42 x 10 mm

IM-04-058-02
9"
42 x 15 mm

IM-04-058-03
9"
43 x 20 mm

Retractor
Kocher

Retractor



Retractor
Middeldorpf



IM-04-059-01
8 1/2"
18 x 17 mm



IM-04-059-02
9"
25 x 22 mm

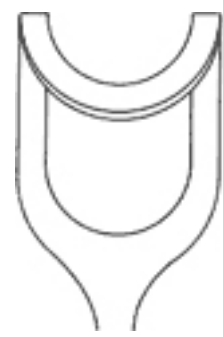

IM-04-059-03
9 3/4"
30 x 31 mm

Retractor



Retractor
Richardson-Eastman
IM-04-060-01
10 1/4"
Fig. 128 x 20 mm + 36 x 28 mm



Retractor
Richardson-Eastman
IM-04-060-02
10 1/2"
Fig. 249 x 38 mm + 63 x 49 mm

Retractor



Retractor
Richardson



IM-04-061-01
9 1/4"
30 x 21 mm



IM-04-061-02
9 1/2"
37 x 29 mm



IM-04-061-03
9 1/2"
45 x 40 mm

Retractor



Retractor
Richardson
IM-04-062-24
9 1/2"
53 x 22 mm



Retractor
Kelly
IM-04-063-26
10 1/4"
70 x 50 mm

Retractor



Retractor
Doyen-Stillie

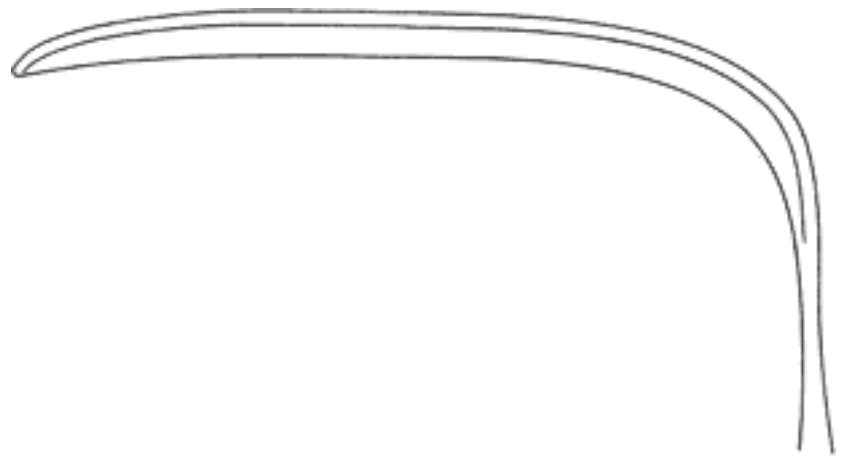

IM-04-064-01
10 1/4"
97 x 29 mm

IM-04-064-02
10 1/4"
101 x 31 mm

IM-04-064-03
10 1/4"
127 x 52 mm

Retractor



Retractor
Hösel

IM-04-065-01
10 1/4"
63 x 21 mm

IM-04-065-02
10 1/4"
83 x 30 mm

IM-04-065-03
10 1/4"
103 x 30 mm

IM-04-065-04
10 1/4"
120 x 30 mm

IM-04-065-05
10 1/4"
140 x 30 mm

IM-04-065-06
10 1/4"
140 x 40 mm

Retractor



Retractor
Middeldorpf



IM-04-066-01
10 3/4"
48 x 45 mm



IM-04-066-02
10 3/4"
52 x 50 mm



IM-04-066-03
11"
60 x 70 mm

Retractor



IM-04-467-00
9 1/4"
37 x 31 mm



IM-04-467-01
9 1/2"
38 x 40 mm



IM-04-467-02
9 3/4"
43 x 51 mm



IM-04-467-03
9 1/4"
49 x 61 mm



IM-04-467-04
10"
48 x 75 mm

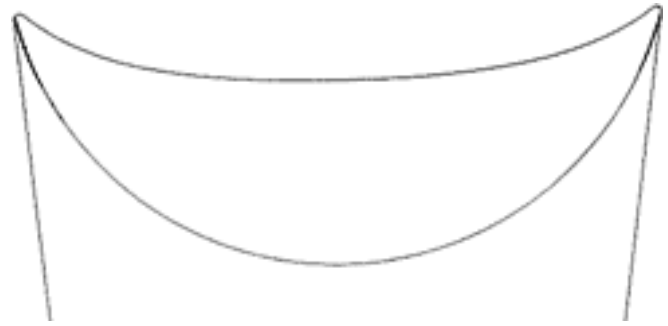

IM-04-467-06
10 1/2"
65 x 85mm



Retractor
Fritsch

Retractor



Retractor
Doyen
IM-04-468-25
9 1/2"
48 x 88 mm



Retractor
Kocher
IM-04-469-22
9 1/2"
73 x 25 mm

Retractor



Retractor
Kocher
IM-04-470-45
9 3/4"
80 x 45 mm



Retractor
Kocher
IM-04-470-55
9 3/4"
80 x 55 mm



Retractor
Kocher
IM-04-470-65
9 3/4"
80 x 65 mm

Retractor



Retractor
Martin
IM-04-471-25
10 1/4"
110 x 27 mm

Retractor

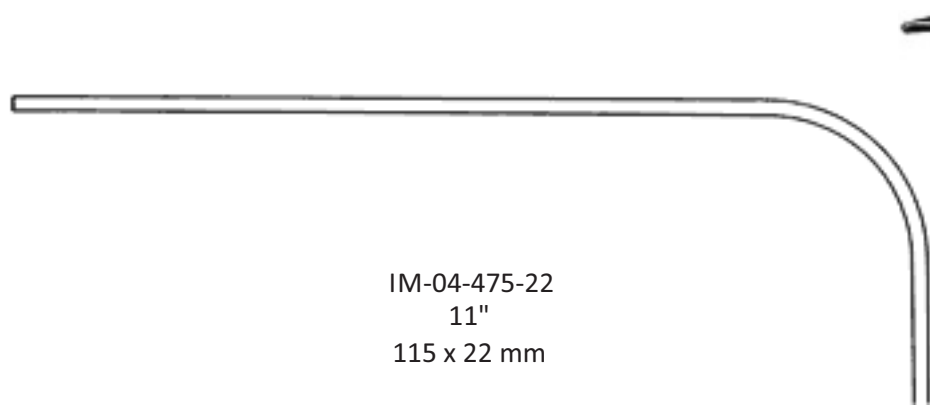

IM-04-475-22
11"
115 x 22 mm

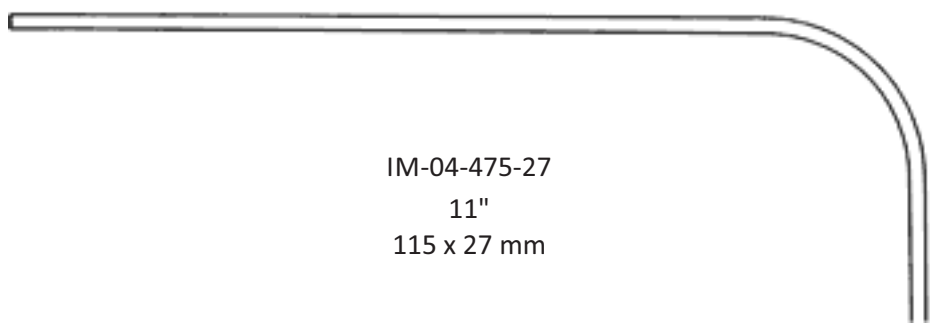

IM-04-475-27
11"
115 x 27 mm

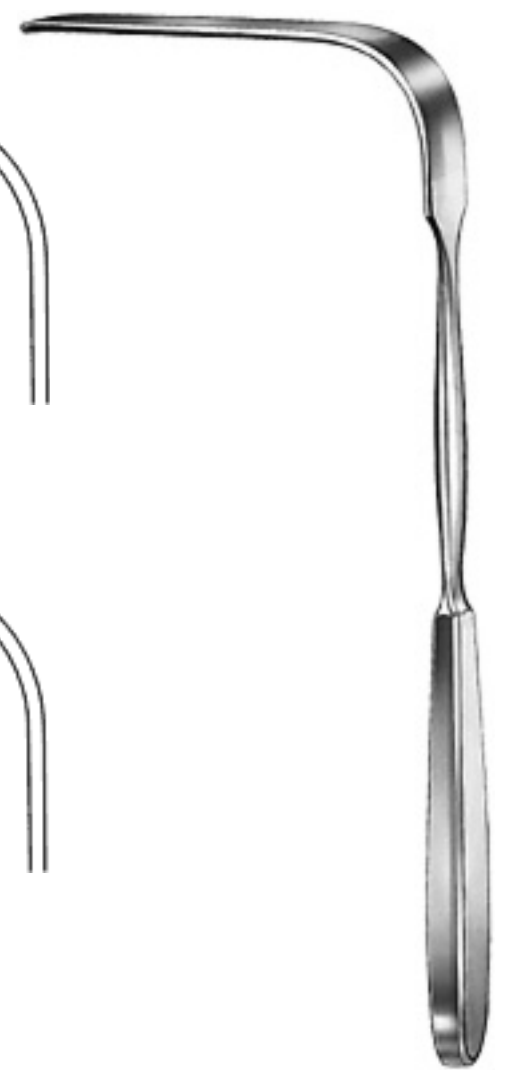

Retractor
Simon

Retractor

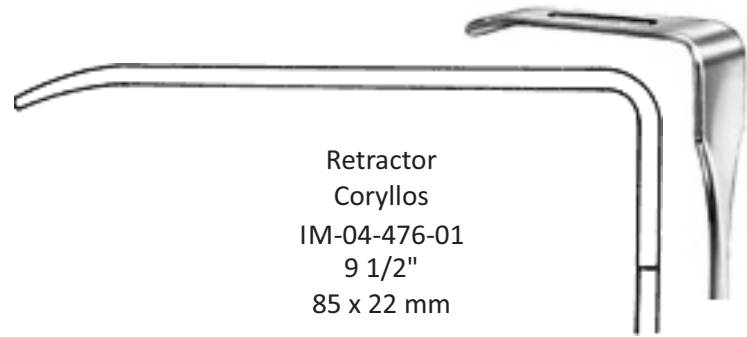

Retractor
Coryllos
IM-04-476-01
9 1/2"
85 x 22 mm

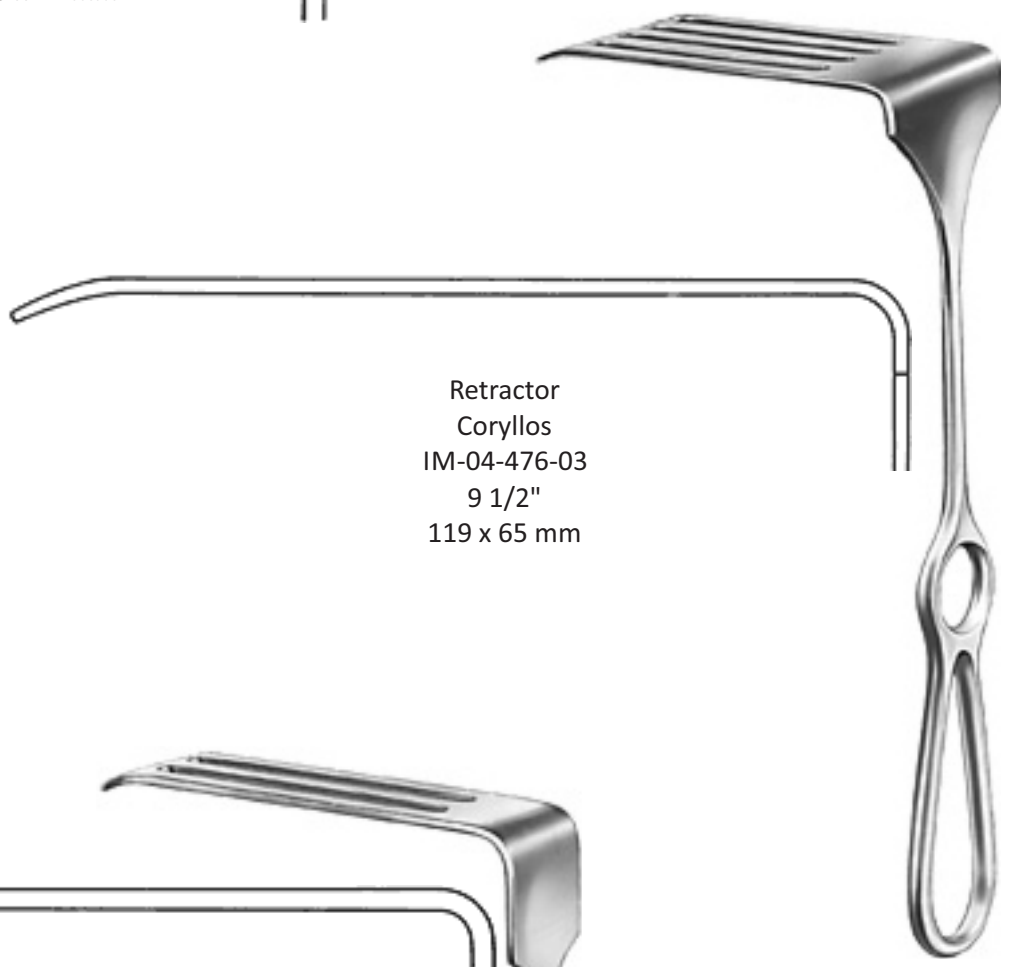

Retractor
Coryllos
IM-04-476-03
9 1/2"
119 x 65 mm

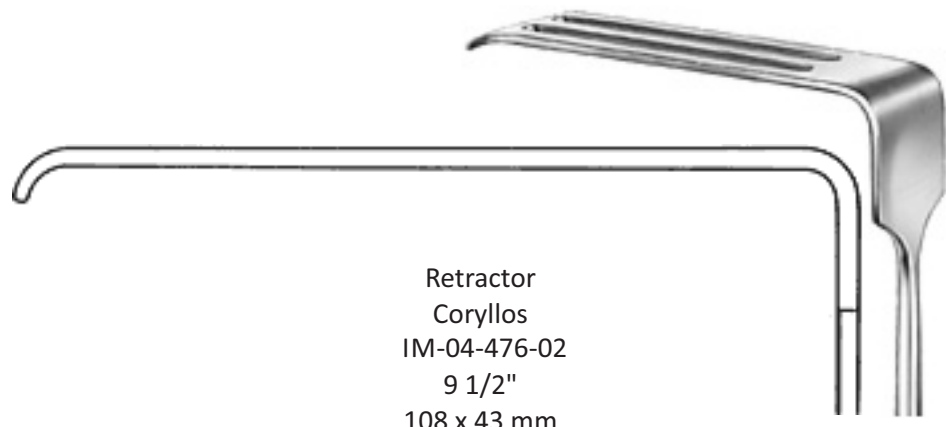

Retractor
Coryllos
IM-04-476-02
9 1/2"
108 x 43 mm

Retractor



Scapula Retractor
Davidson
IM-04-477-54
7 1/2"
80 x 54 mm

Scapula Retractor
Davidson
IM-04-477-95
7 1/4"
80 x 95 mm

Retractor

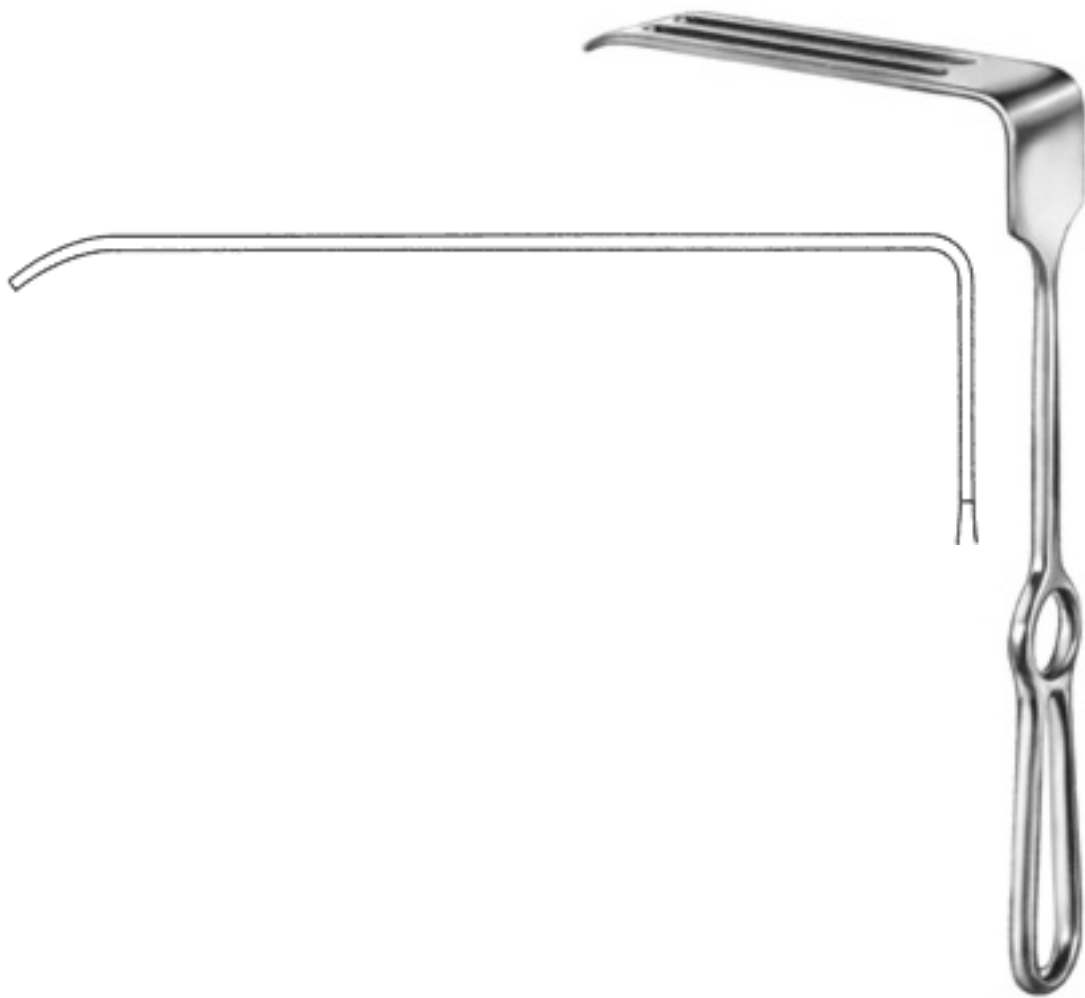

Retractor
Sauerbruch
IM-04-478-38
10"
127 x 38 mm

Retractor



Retractor
Sauerbruch



IM-04-480-15
8 3/4"
50 x 15 mm

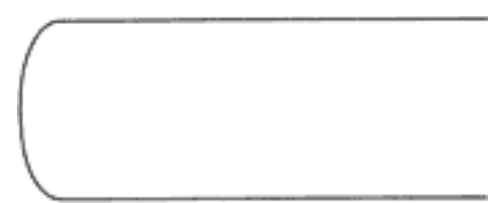

IM-04-480-20
8 3/4"
63 x 23 mm



IM-04-480-23
8 3/4"
80 x 20 mm

Retractor



Aorta Retractor
Crawford



IM-04-482-15
7 ½"
15 x 15 mm

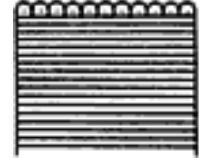

IM-04-482-23
7 ½"
15 x 23 mm

Retractor



Aorta Retractor
Ross



IM-04-485-01
10"
Fig. 1



IM-04-485-02
10"
Fig. 2



IM-04-485-03
10"
Fig.3



IM-04-485-04
10"
Fig. 4



IM-04-485-05
10"
Fig. 5



IM-04-485-06
10"
Fig. 6

Retractor

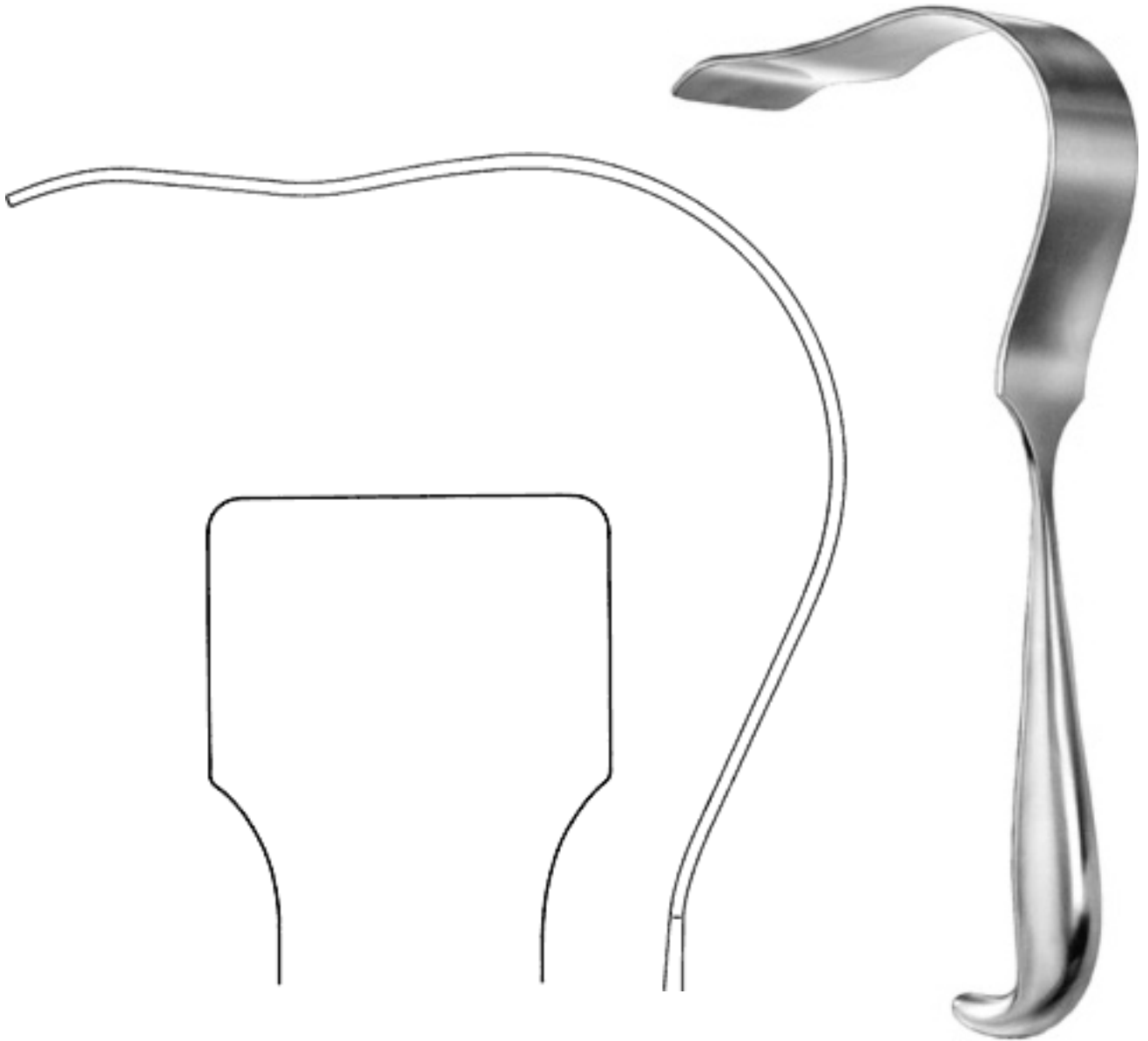

Retractor
Polloson
IM-04-487-27
11 1/2"

Retractor



Retractor
Polloson
IM-04-490-27
10"

Retractor

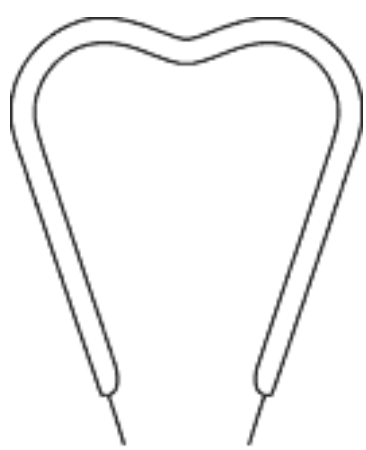

IM-04-495-01
12 1/2"
137 x 44 mm

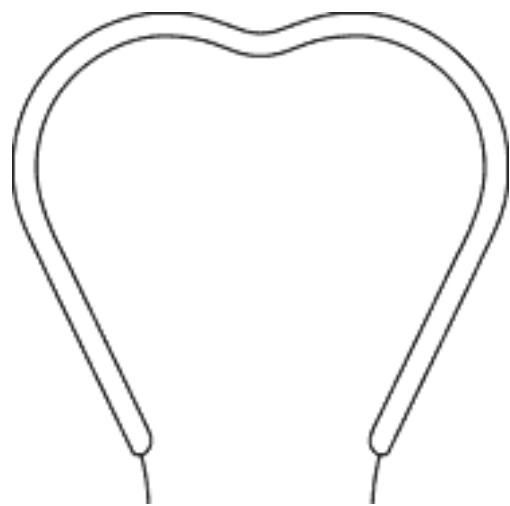

IM-04-495-02
13"
137 x 65 mm



Retractor
Harrington

Retractor



Retractor
Deaver
IM-04-500-01
7"
19 mm



Retractor
Deaver
IM-04-500-02
8 1/2"
22 mm



Retractor
Deaver
IM-04-500-03
9 3/4"
25 mm

Retractor



IM-04-500-04
Retractor
Deaver
12 1/4"
25 mm



IM-04-500-05
Retractor
Deaver
13"
25 mm



IM-04-500-06
Retractor
Deaver
14 1/4"
25 mm

Retractor



Retractor
Deaver
IM-04-500-07
11 3/4"
38 mm



Retractor
Deaver
IM-04-500-08
12 1/4"
50 mm



Retractor
Deaver
IM-04-500-09
12 1/2"
75 mm

Retractor

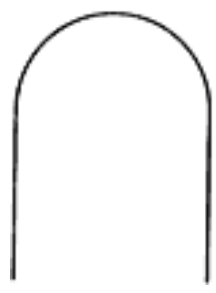

IM-04-502-04
12 ½ "
25 mm

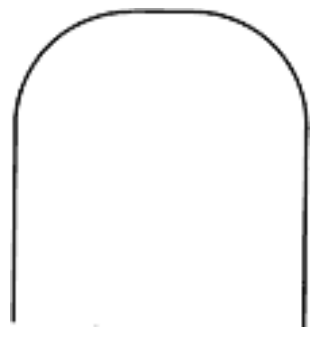

IM-04-502-07
12 ½ "
38 mm

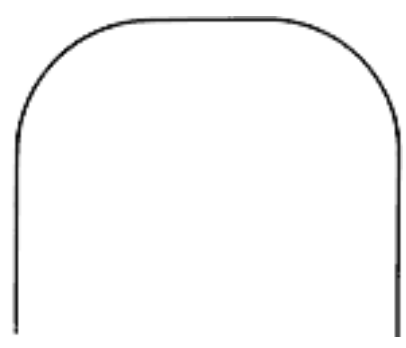

IM-04-502-08
12 ½ "
50 mm

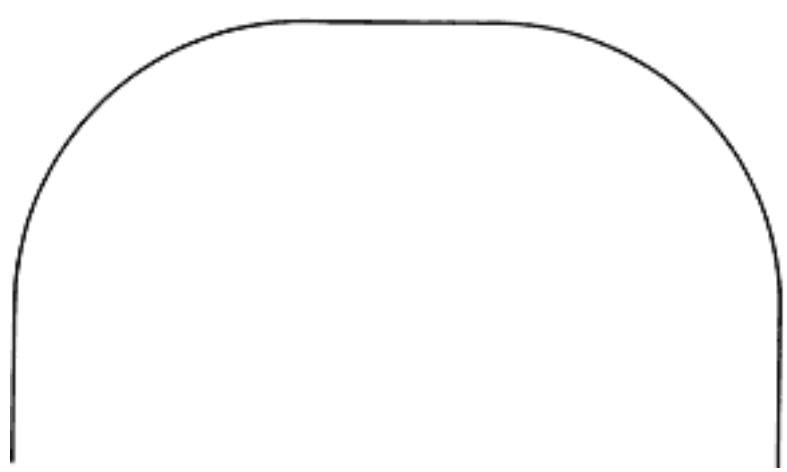

IM-04-502-10
12 ½ "
100 mm



Retractor
Deaver

Retractor

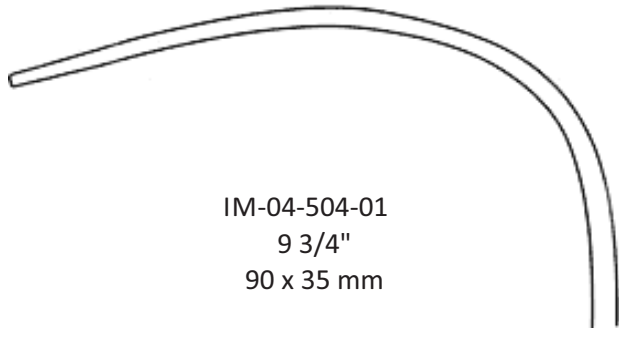

IM-04-504-01
9 3/4"
90 x 35 mm

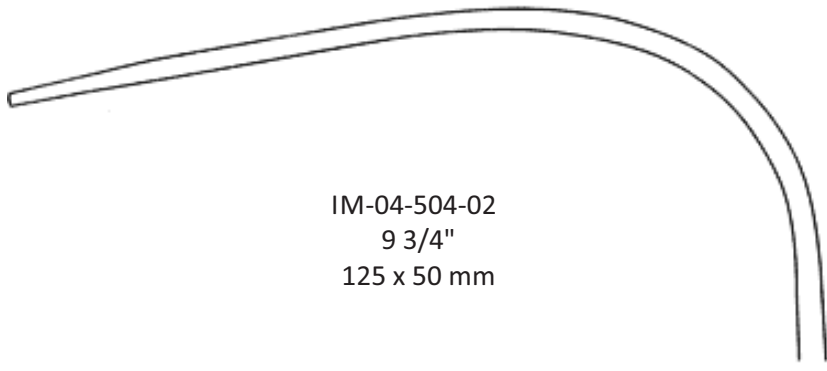

IM-04-504-02
9 3/4"
125 x 50 mm

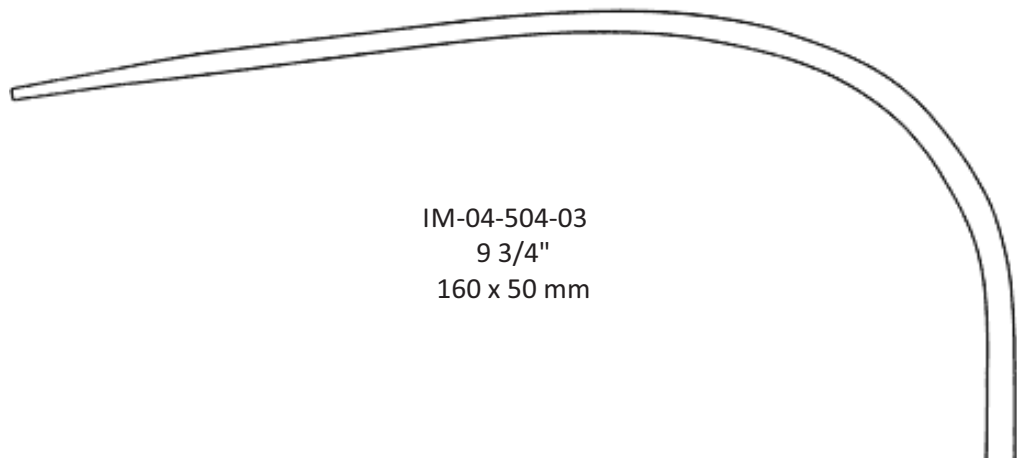

IM-04-504-03
9 3/4"
160 x 50 mm



Liver Retractor
Mikulicz

Retractor



Retractor
Mikulicz
IM-04-506-26
90 x 55 mm

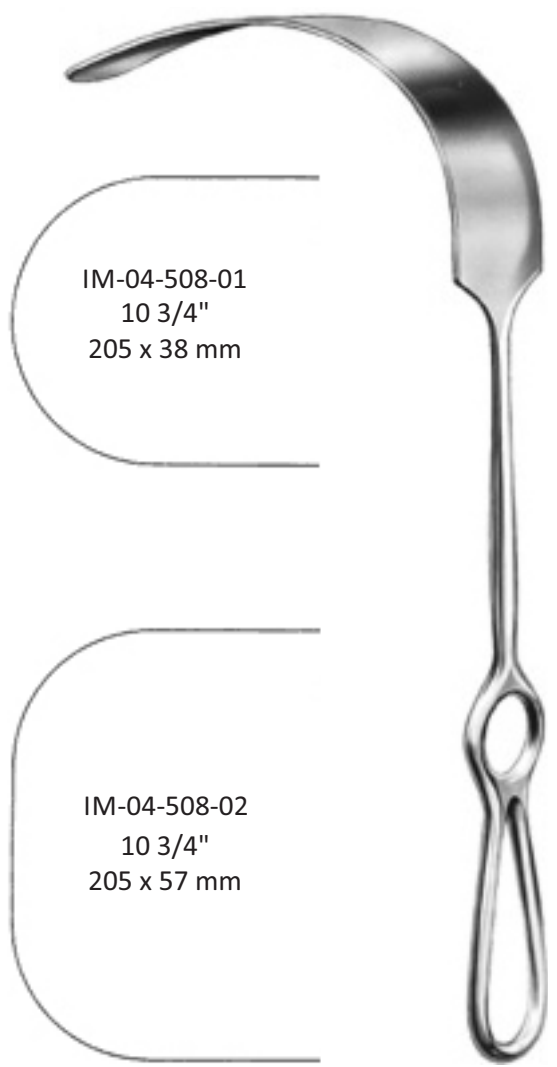

Retractor
Kelly

Retractor



Pelvis Retractor
St. Marks

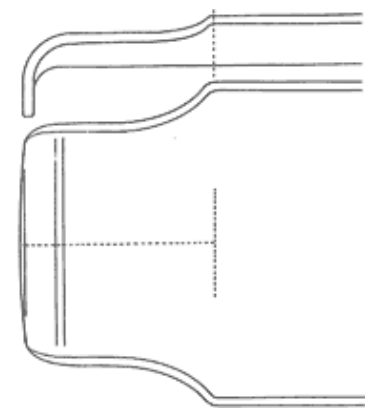

IM-04-510-01
11 1/2"
142 x 60 mm 35 x 45 mm

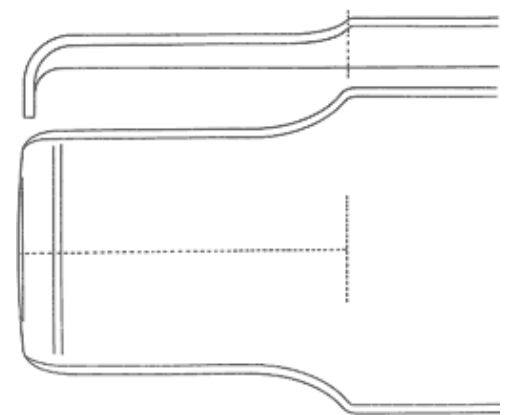

IM-04-510-02
11 1/2"
193 x 60 mm 60 x 45 mm

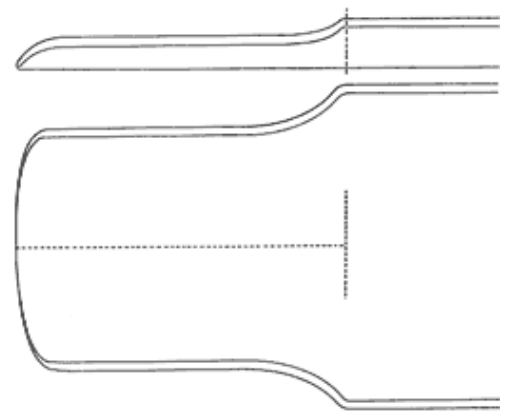

IM-04-510-03
13"
195 x 60 mm 60 x 45 mm

Retractor



Abdominal Spatula
Kümmel
IM-04-512-28
12 1/4"
100 x 45 mm

Retractor



Abdominal Spatula
Kader



IM-04-514-20
11"
20 mm



IM-04-514-30
11"
30 mm



IM-04-514-40
11"
40 mm

Retractor



Retractor
Roux



IM-04-516-00
6 3/4"
Fig. 1-3



IM-04-516-01
5 1/2"
Fig. 1



IM-04-516-02
6"
Fig. 2

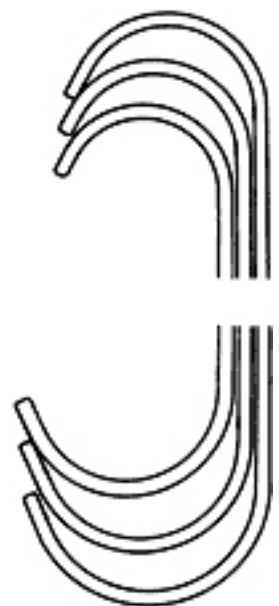

IM-04-514-03
6 3/4"
Fig. 3

Retractor

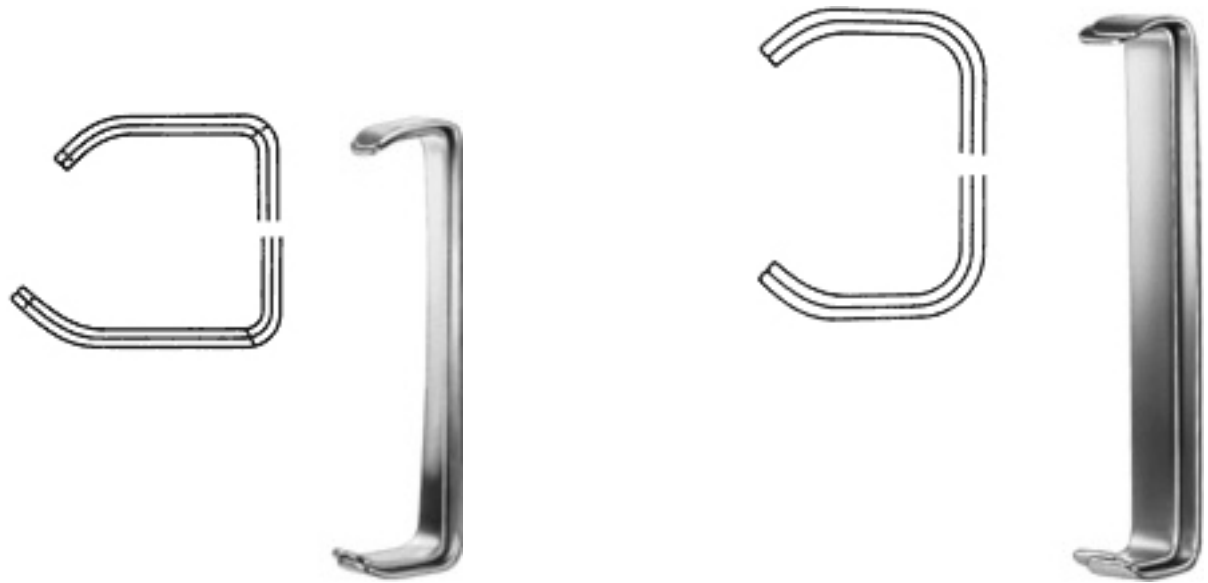

Retractor
Farabeuf
IM-04-518-00
4 1/2"
Fig. 1 – 2
Fig. 2 = 30 x 10 mm
Fig. 1 = 26 x 10 mm
Fig. 1 = 30 x 13 mm
Fig. 2 = 34 x 13 mm

Retractor
Farabeuf
IM-04-519-00
6"
Fig. 1 – 2
Fig. 2 = 27 x 16 mm
Fig. 1 = 23 x 16 mm
Fig. 1 = 26 x 16 mm
Fig. 2 = 30 x 16 mm

Retractor



Retractor
Roux-Mini
IM-04-520-06
5 3/4"
8 x 6 mm



Retractor
Roux-Baby
IM-04-524-13
5"

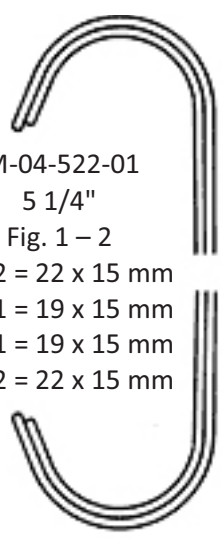

IM-04-522-01
5 1/4"
Fig. 1 - 2
Fig. 2 = 22 x 15 mm
Fig. 1 = 19 x 15 mm
Fig. 1 = 19 x 15 mm
Fig. 2 = 22 x 15 mm



Retractor
Parker

Retractor



IM-04-526-02
7"
Fig. 1 - 2
Fig. 2 = 29 x 25 mm
Fig. 1 = 26 x 25 mm
Fig. 1 = 27 x 25 mm
Fig. 2 = 27 x 25 mm



Retractor
Parker

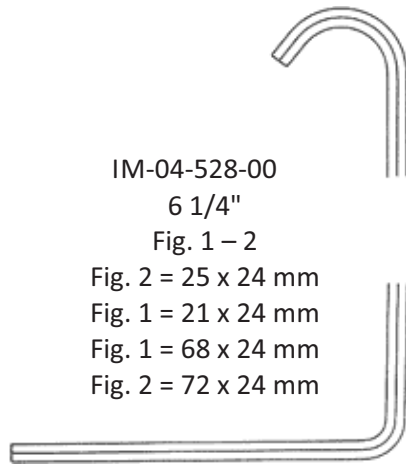

IM-04-528-00
6 1/4"
Fig. 1 - 2
Fig. 2 = 25 x 24 mm
Fig. 1 = 21 x 24 mm
Fig. 1 = 68 x 24 mm
Fig. 2 = 72 x 24 mm



Retractor
Parker-Mott

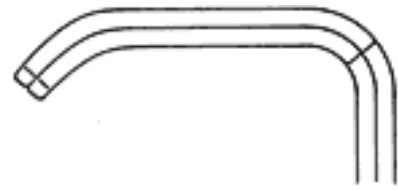

IM-04-530-00
8" Fig. 1 - 2
Fig. 2 = 47 x 13 mm
Fig. 1 = 42 x 13 mm
Fig. 1 = 42 x 26 mm
Fig. 2 = 46 x 26 mm

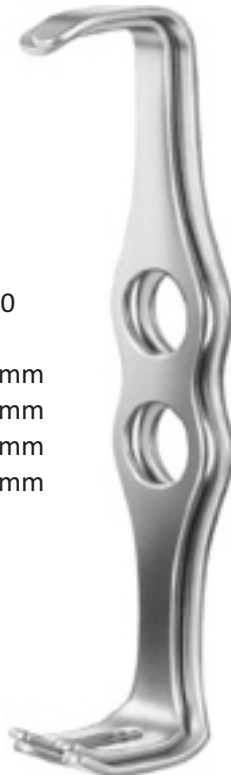

Retractor
Mathieu



Retractor

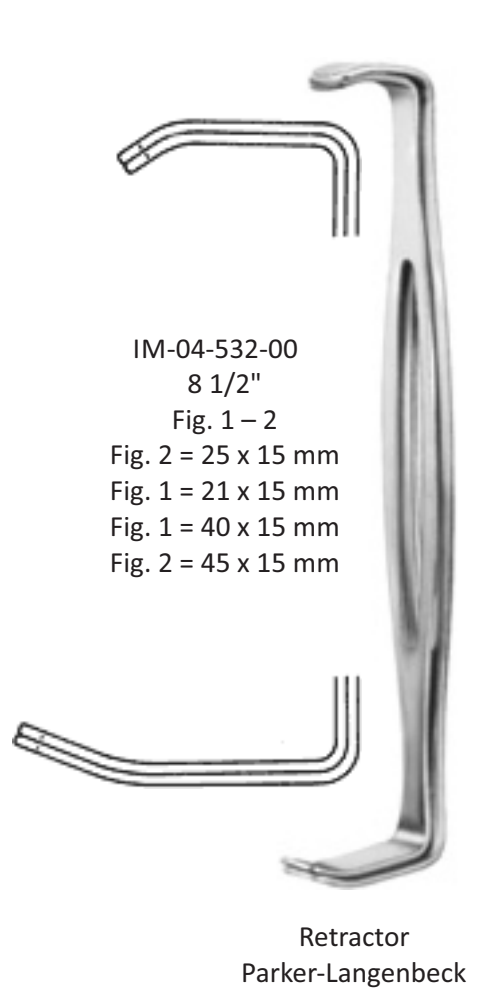

Retractor



Wound Spreaders
self-retaining
Finsen



IM-04-535-05
2"
sharp 2 x 3 teeth



IM-04-536-05
2"
blunt 2 x 3 teeth



IM-04-537-05
2 3/4"
sharp teeth 3 x 4



IM-04-538-05
2 3/4"
blunt 3 x 4 teeth



Wound Spreaders
self-retaining
Finsen-Martin



IM-04-540-07
2 3/4"
sharp 3 x 4 teeth

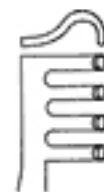

IM-04-542-07
2 3/4"
blunt 3 x 4 teeth

Retractor



Wound Spreader, self-retaining
Logan
IM-04-544-04
1 1/2"
sharp



Fat Spreader
IM-04-545-30
1 1/4"



Fat Spreader
IM-04-545-40
1 1/2"



Fat Spreader
IM-04-545-50
2 1/4"

Retractor

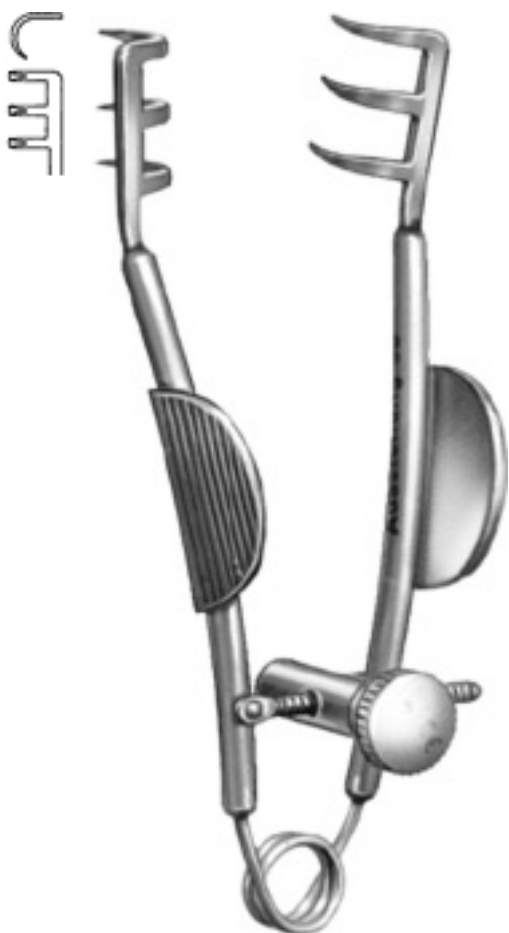

Wound Spreaders, self-retaining
Buckley
IM-04-550-06
2 1/4"



Wound Spreaders
self-retaining
Alm

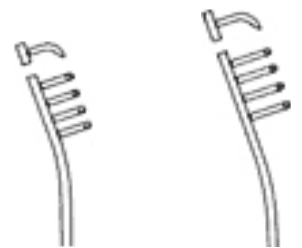

IM-04-552-04 IM04-552-10
2 3/4" 4 "
sharp sharp
4 x 4 teeth 4 x 4 teeth



IM-04-555-07 IM-04-555-10
2 3/4" 4 "
blunt blunt
4 x 4 teeth 4 x 4 teeth

Retractor

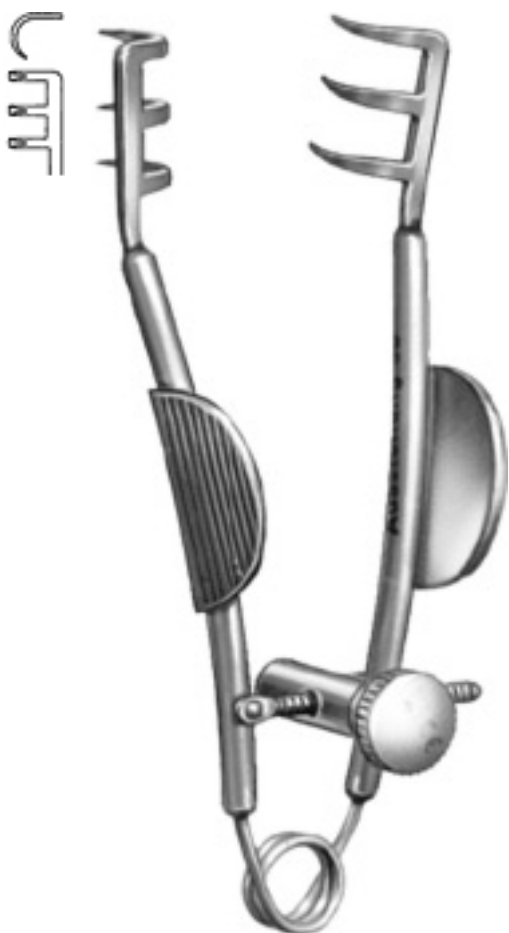

Wound Spreaders, self-retaining
Buckley
IM-04-550-06
2 1/4"



Wound Spreaders
self-retaining
Alm

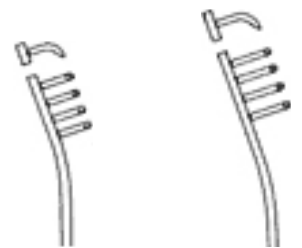

IM-04-552-07 ZI-06-714-10
2 3/4" 4 "
sharp sharp
4 x 4 teeth 4 x 4 teeth



IM-04-555-07 IM-04-555-10
2 3/4" 4 "
blunt blunt
4 x 4 teeth 4 x 4 teeth

Retractor



Wound Spreaders, self-retaining
IM-04-560-10
4 "



Wound Spreaders, self-retaining
Jansen
IM-04-561-10
4 "
blunt

Retractor



Wound Spreaders, self-retaining
Scalp-Contour

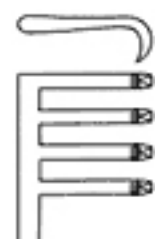

IM-04-562-14
5 1/4"
sharp
3:4 teeth

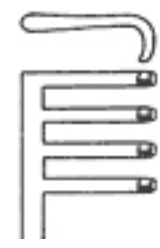

IM-04-563-14
5 1/4"
blunt
3:4 teeth

Retractor

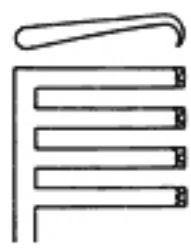

Wound Spreaders, self-retaining
Anderson-Adson
IM-04-565-20
8"
sharp
4:4 teeth

Retractor

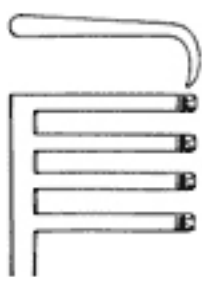

IM-04-567-20
8"
sharp
3:4 teeth

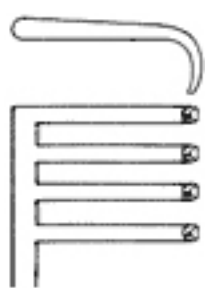

IM-04-568-20
8"
blunt
3:4 teeth



Wound Spreaders, self-retaining
Weitlaner

Retractor



Wound Spreaders, self-retaining
Adson

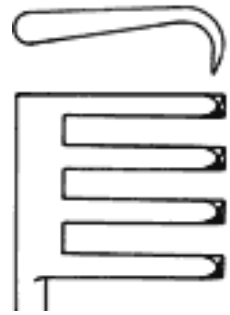

IM-04-570-26
10 1/4"
sharp
3:4 teeth

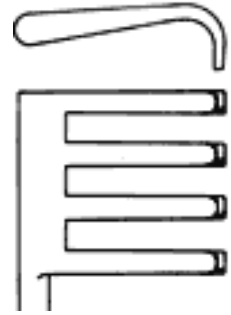

IM-04-571-26
10 1/4"
blunt
3:4 teeth

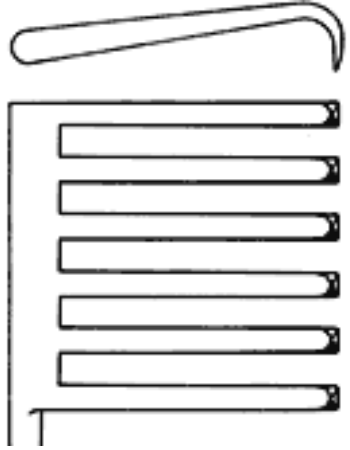

IM-04-572-26
11 1/2"
sharp
6:6 teeth

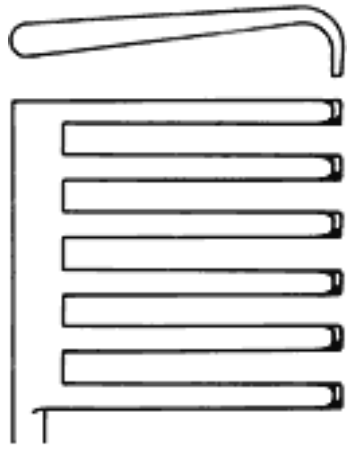

IM-04-573-26
11 1/2"
blunt
6:6 teeth

Retractor



Wound Spreaders, self-retaining
Weitlaner



IM-04-575-13
5 1/4"
sharp
3:4 teeth

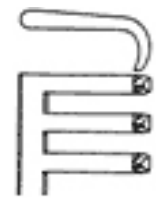

IM-04-575-16
6 1/4"
sharp
3:4 teeth

Retractor



Wound Spreaders, self-retaining
Weitlaner

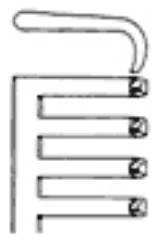

IM-04-578-13
5 1/4"
blunt
3:4 teeth

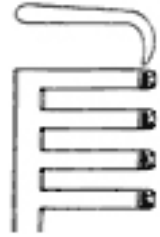

IM-04-578-16
6 1/4"
blunt
3:4 teeth

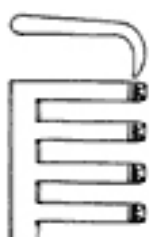

IM-04-579-13
5"
sharp
3:3 teeth

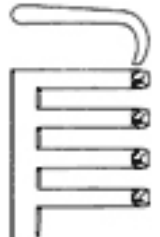

IM-04-579-16
5"
blunt
3:3 teeth

Retractor



Wound Spreaders, self-retaining
Mollison
IM-04-580-15
6"
sharp4:4 teeth

Retractor

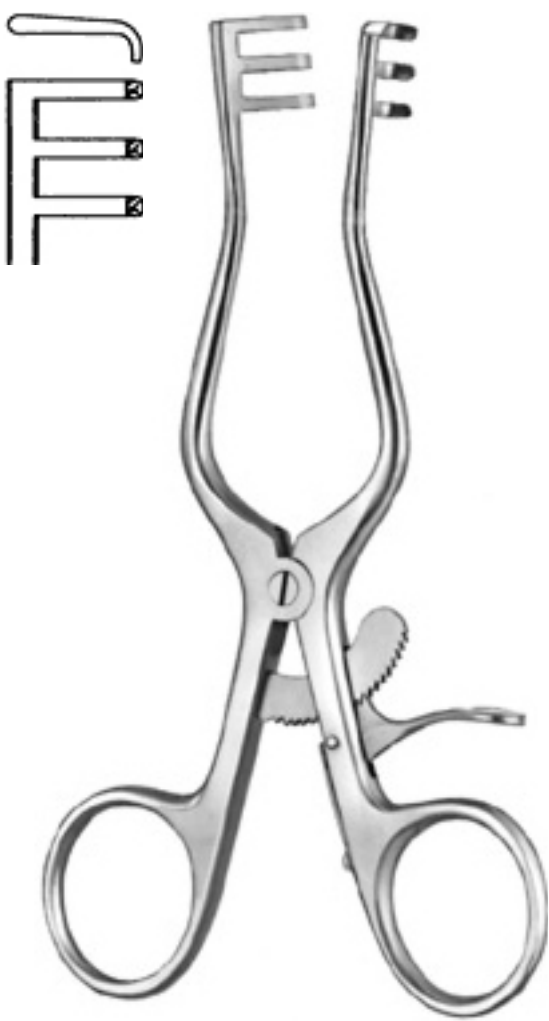

Wound Spreaders, self-retaining
Milligan
IM-04-582-13
5 1/4"
blunt
3:3 teeth

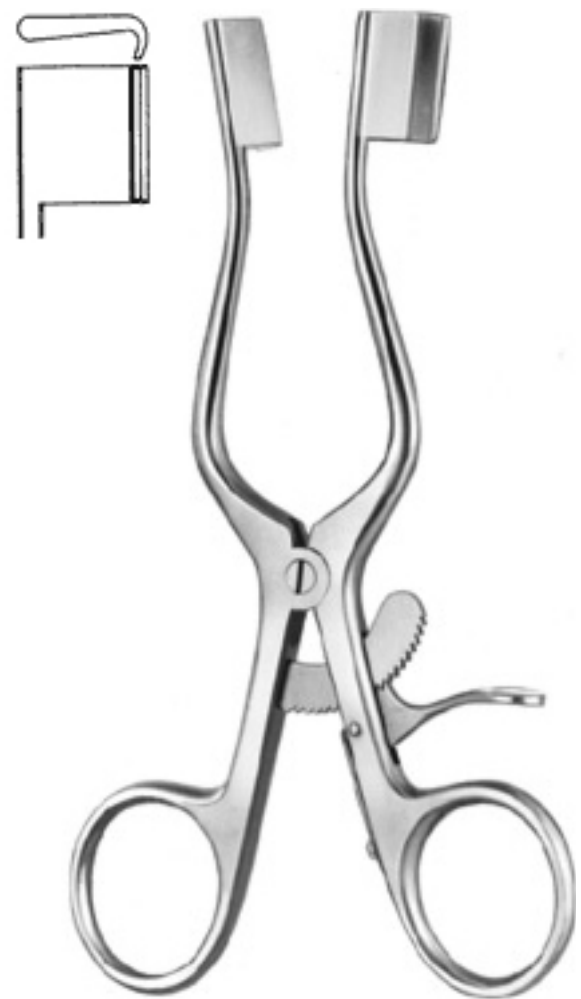

Wound Spreaders, self-retaining
Weitlaner, Baby
IM-04-583-13
5 1/4"

Retractor

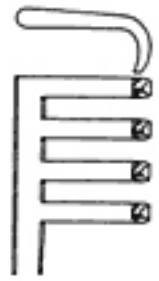

Wound Spreaders, self-retaining
Henley
IM-04-585-00
6 1/4"
complete with 3 central blades ref.
15-768-19, -25 and -32blunt3:4 prongs

Retractor



Central Blade
Henley



IM-04-590-19



IM-04-590-25



IM-04-590-32

Retractor

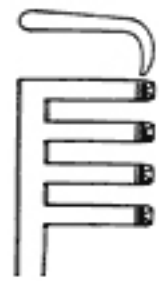

Wound Spreaders, self-retaining
Henley
IM-04-595-00
6 1/4"

Retractor



Wound Spreaders, self-retaining
Adson

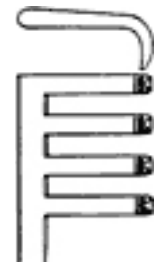

IM-04-600-13
5 1/4"
sharp3:4 teeth

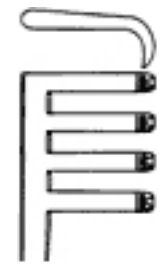

IM-04-600-16
6 1/2"
sharp3:4 teeth

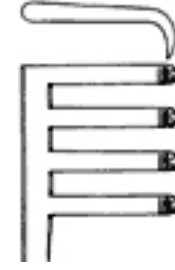

IM-04-600-20
8 1/4"
sharp3:4 teeth

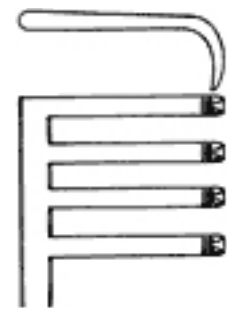

IM-04-600-26
9 3/4"
sharp3:4 teeth

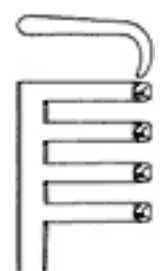

IM-04-601-13
5 1/4"
blunt3:4 teeth

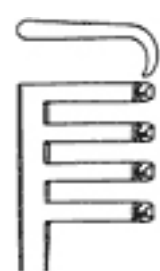

IM-04-601-16
6 1/2"
blunt3:4 teeth



IM-04-601-20
8 1/4"
blunt3:4 teeth

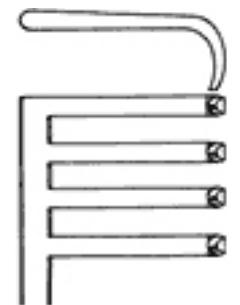

IM-04-601-26
9 3/4"
blunt3:4 teeth

Retractor



Wound Spreaders, self-retaining
IM-04-602-00
9 3/4"
completewith 2 each plug-in blades ref.
04-602-40 – 04-602-60



Cloward



Blades, (pair)
IM-04-602-25
deep 40 mm



Blades, (pair)
IM-04-602-40
deep 40 mm



Blades, (pair)
IM-04-602-45
deep 45 mm



Blades, (pair)
IM-04-602-50
deep 50 mm



Blades, (pair)
IM-04-602-55
deep 55 mm



Blades, (pair)
IM-04-602-60
deep 60 mm

Retractor

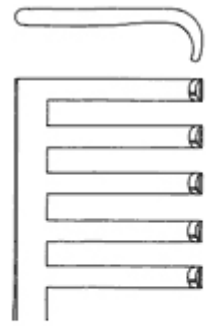

Beckmann
Wound Spreaders
self-retaining
IM-04-604-31
12 1/2"sharp4:4 teeth

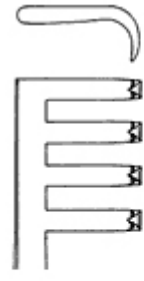

Adson
Wound Spreaders
self-retaining
IM-04-606-32
13"
blunt4:5 teeth

Retractor



Beckman-Adson
Wound Spreaders, self-retaining

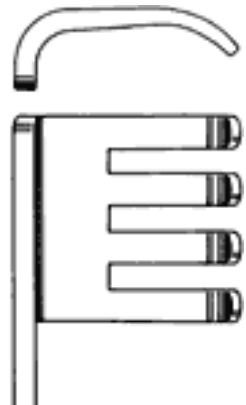

IM-04-610-00
12"
blunt4:4 teeth

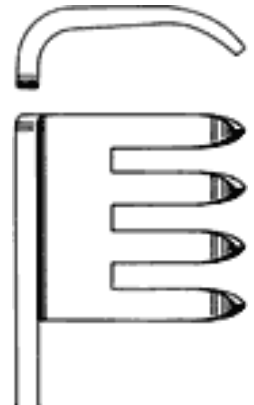

IM-04-610-01
12"
blunt4:4 teeth

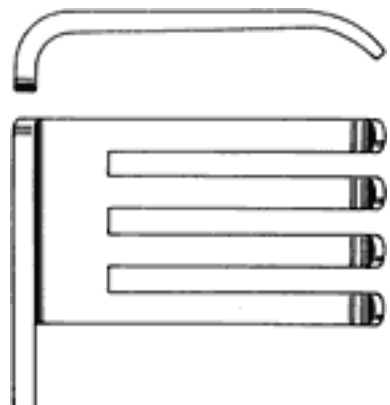

IM-04-610-02
12"
blunt4:4 teeth

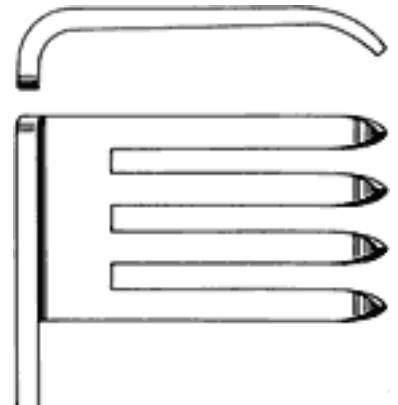

IM-04-610-03
12"
blunt4:4 teeth

Retractor

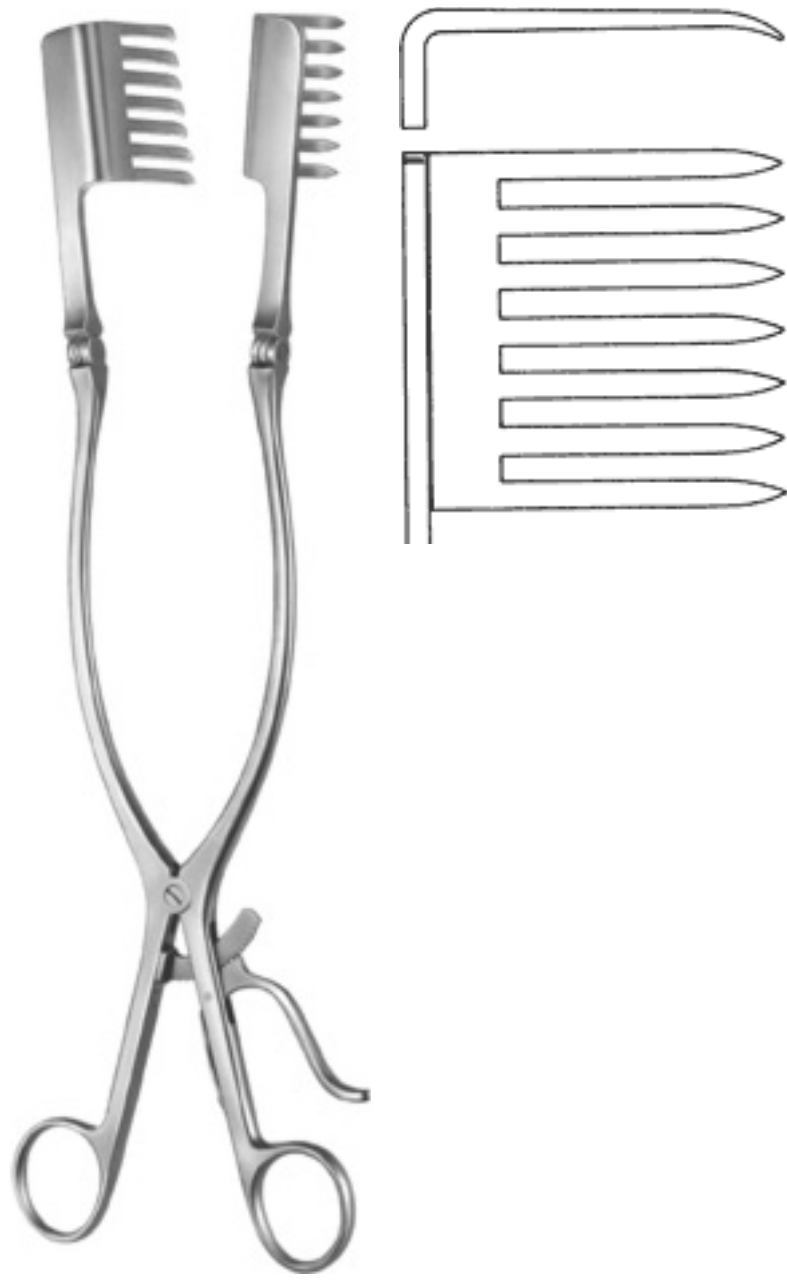

Beckman-Eaton
Wound Spreaders, self-retaining
IM-04-615-32
12 1/2"
sharp 7:7 teeth

Retractor

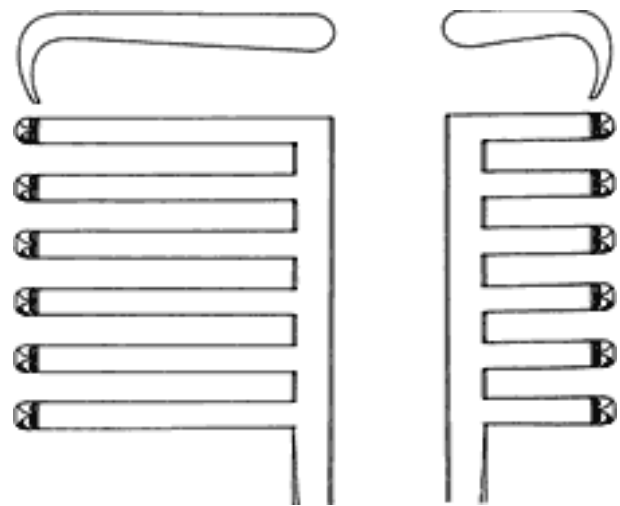

Wound Spreaders, self-retaining
IM-04-620-01
11 1/4"
teeth6:6 teeth



Martin

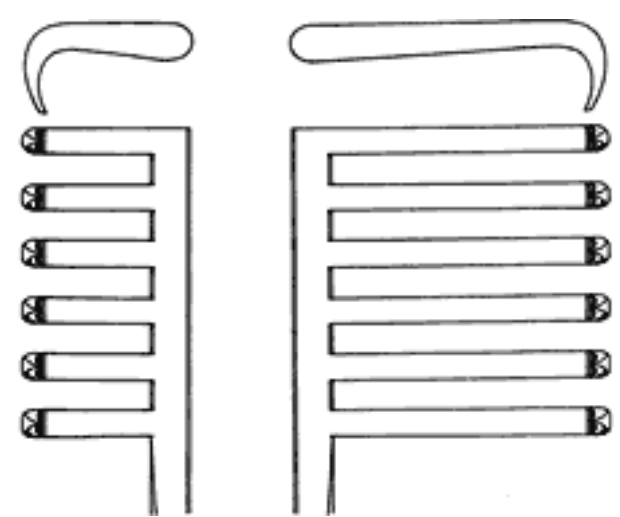

Wound Spreaders, self-retaining
IM-04-620-02
11 1/4"
teeth6:6 teeth

Retractor



Wound Spreader, self-retaining
Vickers
IM-04-625-01
2"
blunt, ring model, for thumb and fingers



Thyroid and Vaginal retractor
Joll
IM-04-625-00
6"

Retractor



Wound Spreaders, self-retaining
Gelpi
IM-04-630-13
5"

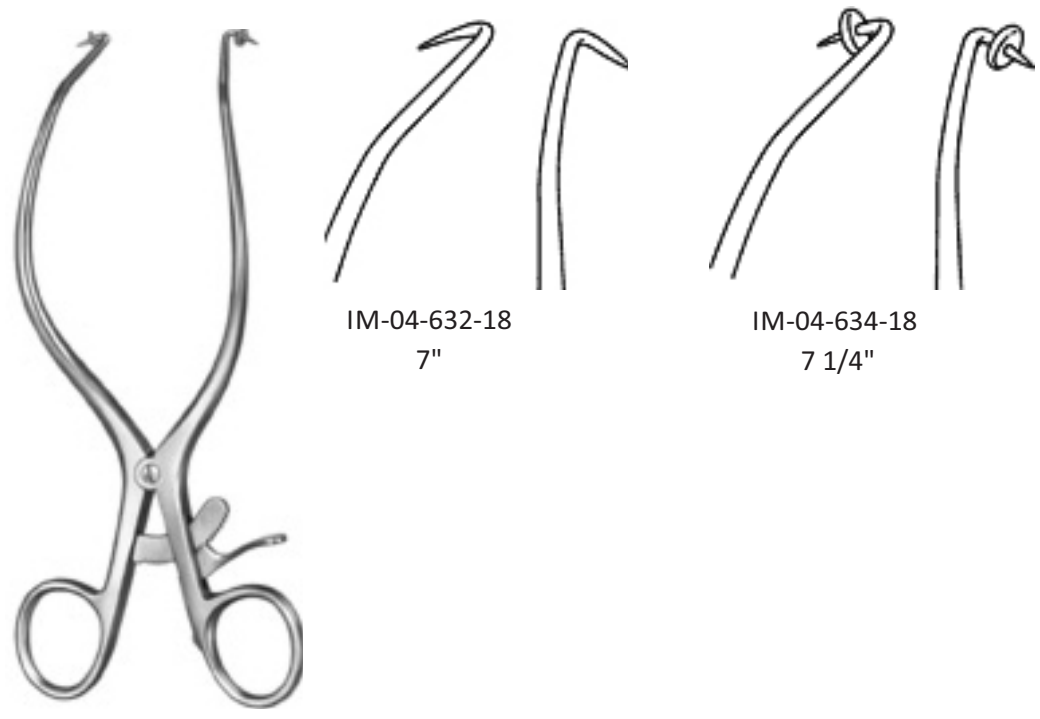

IM-04-632-18
7"

IM-04-634-18
7 1/4"

Wound Spreaders, self-retaining
Gelpi

Retractor



Abdominal Retractor
Collin, Baby
IM-04-635-00
8"

complete, with 2 pairs of lateral blades (18 x 40 mm) and (27 x 40 mm)

Retractor



Abdominal Retractor
Collin
IM-04-640-22
9 1/4
complete, with 1 pair of lateral blades ref
(38 x 60 mm)



Abdominal Retractor
Collin
IM-04-645-00
9"
complete, with 1 pair of lateral blades ref.
15-839-38 (38 x 60 mm) and central blade 38 x 55 mm

Retractor



Abdominal Retractor
Collin
IM-04-648-00
12 1/4"
complete, with 1 pair of lateral blades.
(60 x 80 mm)
central blade 60 x 75 mm



Abdominal Retractor
Ricard
IM-04-650-00
complete with 1 pair of lateral blades
and central blade ref

Retractor



Spreader, only
Ricard
IM-04-655-01

Abdominal Retractor
Ricard
IM-04-655-00
complete with 1 pair of lateral blades

Central Blade
Ricard
IM-04-655-02
55 x 70 mm

Central Blade
Ricard
IM-04-655-04
80 x 90 mm

Retractor

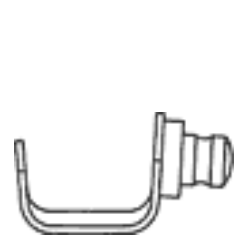

IM-04-660-18
18 x 40 mm

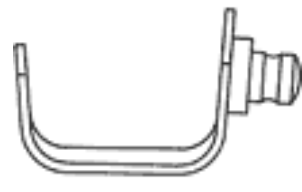

IM-04-660-27
27 x 40 mm

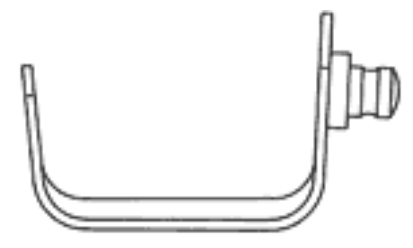

IM-04-660-38
38 x 60 mm



Lateral Blade

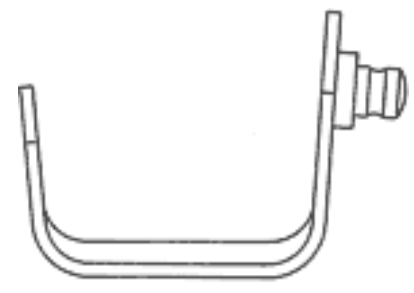

IM-04-660-40
40 x 80 mm

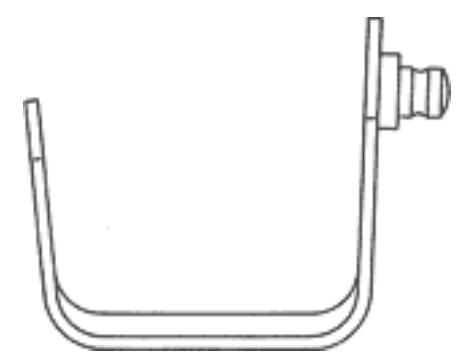

IM-04-660-45
45 x 80 mm

Retractor

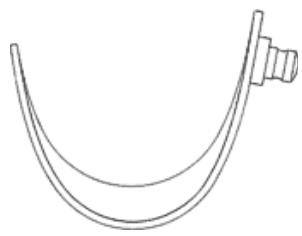

IM-04-665-50
50 x 70 mm

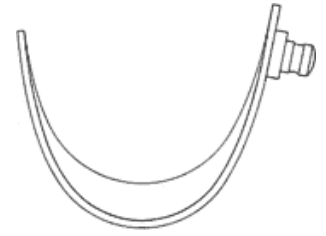

IM-04-665-52
52 x 110 mm

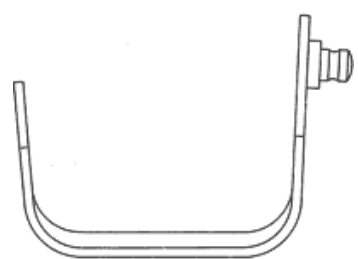

IM-04-665-60
60 x 80 mm

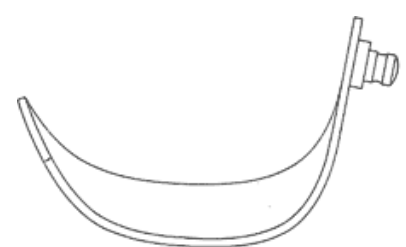

IM-04-665-70
70 x 55 mm



Lateral Blade

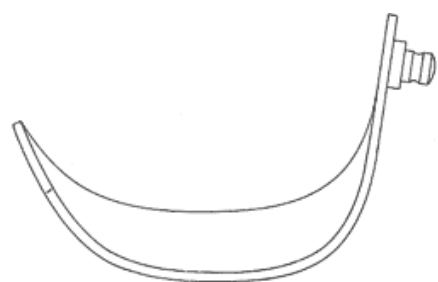

IM-04-665-80
75 x 90 mm

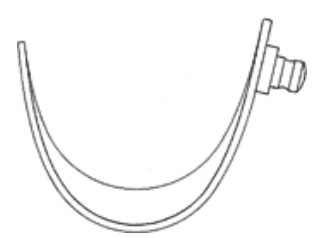

IM-04-665-90
50 x 58 mm

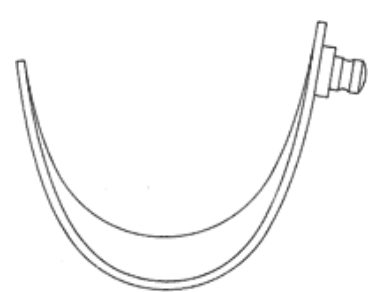

IM-04-665-92
60 x 80 mm



IM-04-665-94
72 x 85 mm

Retractor



Abdominal Retractor
Gosset-Baby
IM-04-670-00
5"
spreading 100 mmlateral blades
40 x 30 mm
IM-04-670-00



Abdominal Retractor
Gosset
IM-04-672-00
6 1/2"
spreading 160 mm lateral blades 63 x 35 mm1 central blade 60 x 56 mm

Retractor

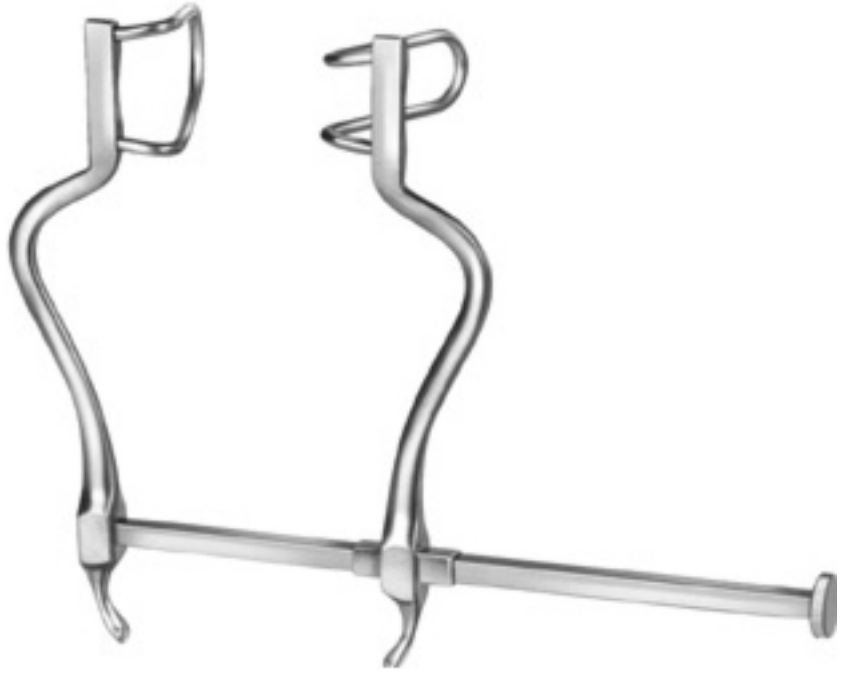

Abdominal Retractor
Gosset
IM-04-675-00
7 1/4"
spreading 140 mmlateral blades 63 x 35 mm



Abdominal Retractor
Balfour-Baby
IM-04-677-00
5"
spreading 90 mm1 central blade 24 x 20 mm

Retractor

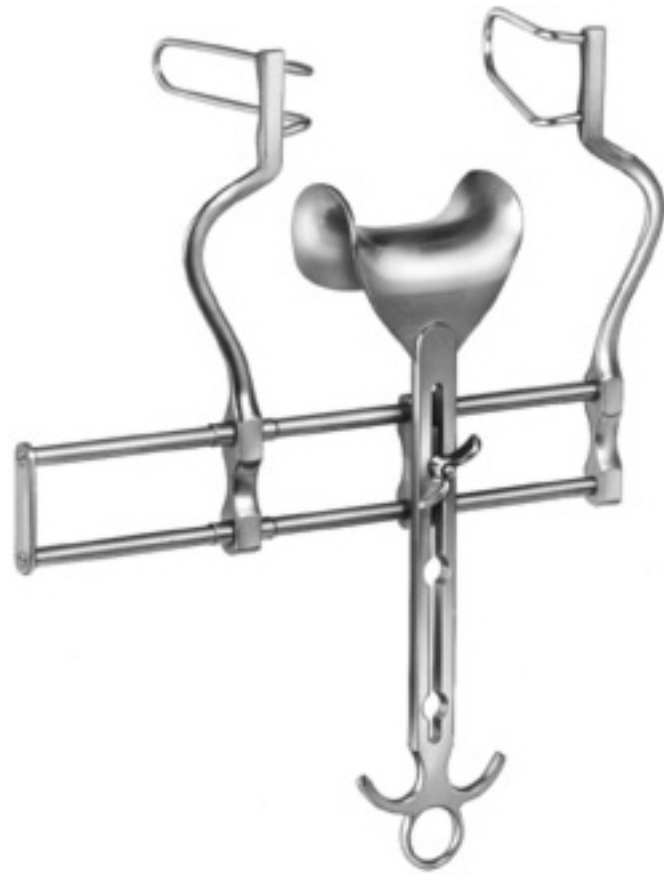

Abdominal Retractor
Balfour
IM-04-680-00
8"
spreading 180 mmlateral blades 70 x 35 mm1
central blade ref.
15-859-01



Abdominal Retractor
Balfour
IM-04-682-00
8"
spreading 180 mmlateral blades 70 x 35 mm1
central blade ref
15-859-01

Retractor



Abdominal Retractor
Balfour
IM-04-685-00
8"
spreading 200 mmlateral blades
100 x 35 mm1 central blade
100 x 60 mm

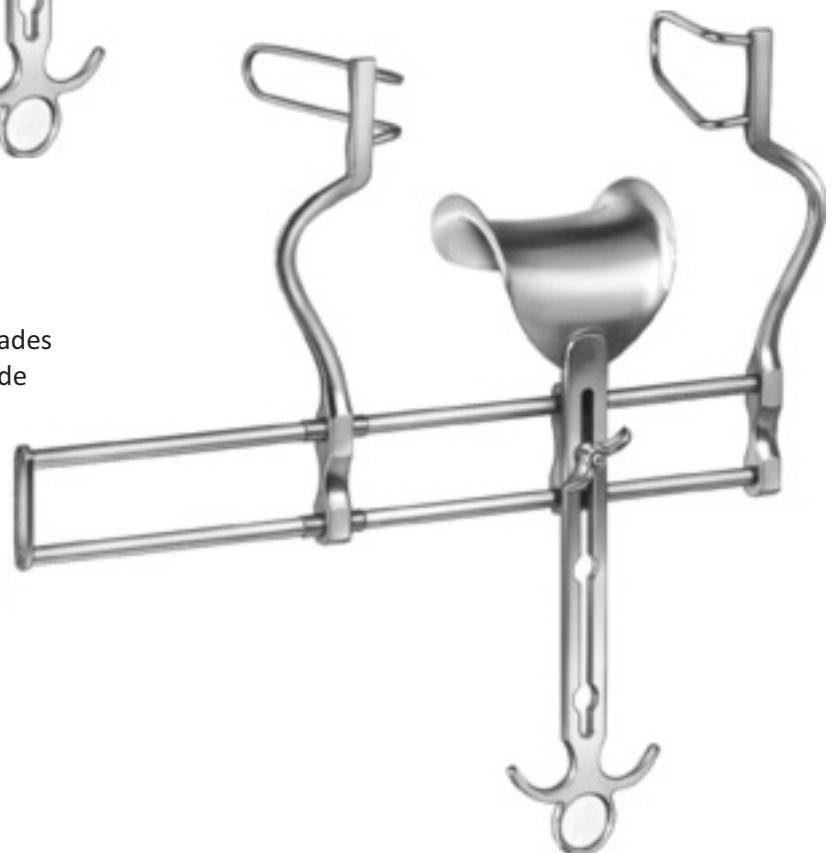

Abdominal Retractor
Balfour
IM-04-687-00
8"
spreading 250 mmlateral
blades 100 x 35 mm1
central blade

Retractor



Central Blade
Balfour
IM-04-690-01
45 x 80 mm



Central Blade
Balfour
IM-04-690-02
68 x 85 mm



Central Blade
Balfour
IM-04-690-03
68 x 85 mm



Central Blade
Balfour
IM-04-690-04
40 x 68 mm

Retractor



Abdominal Retractor
Balfour, Modell USA
IM-04-695-00
with 2 pairs of each lateral blades
and 1 central blade

Retractor



Fenestrated Blade
Balfour, Modell USA
IM-04-700-06
60 mm deep (pair)



Fenestrated Blade
Balfour, Modell USA
IM-04-700-08
80 mm deep (pair)



Abdominal Retractor
O'Sullivan-O'Connor
IM-04-700-00
with 2 fixed lateral blades
1 blade 110 x 70 mm
and 2 blades 80 x 45 mm

Retractor



Abdominal Retractor
Kirschner
IM-04-705-00
oval frame (300 x 240 mm),3 hooks



Frame
Kirschner
IM-04-710-30
340 x 240 mm

Retractor

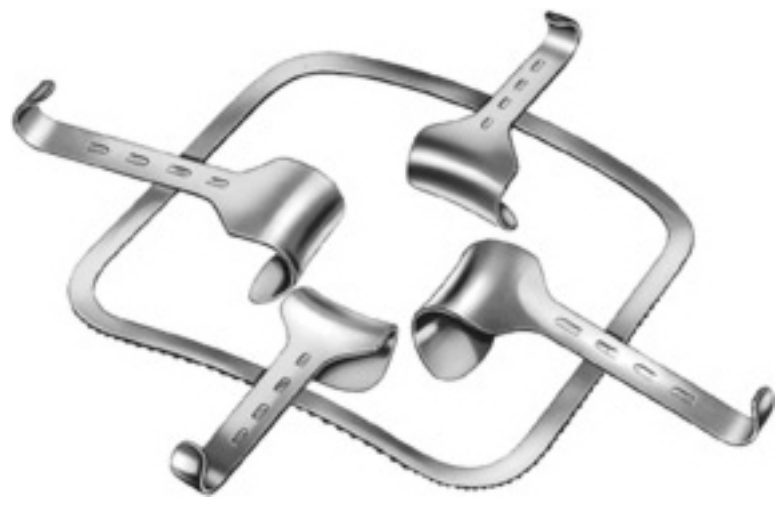

Abdominal Retractor
Kirschner
IM-04-715-00
frame 04-715-24, 2 hooks 04-715-40 and 2 hooks ref. 04-715-50

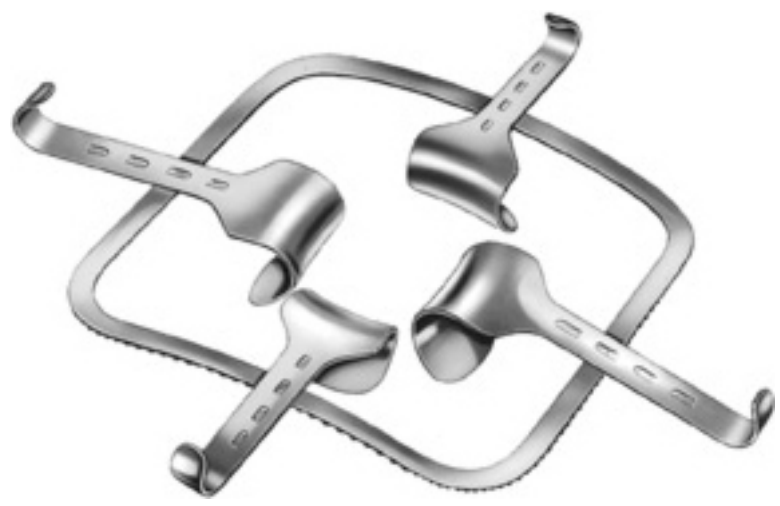

Frame, only
Kirschner
IM-04-720-24
240 x 240 mm

Retractor



Laminectomy Retractor
Scoville
IM-04-725-00
6"
spreading 150 mm

Retractor



Laminectomy Retractor
Scoville-Haverfield
IM-04-730-50
6"
spreading 150 mm

Retractor



Abdominal Spatula
IM-04-735-01
13"
30 mm wide

Abdominal Spatula
IM-04-735-02
13"
40 mm wide

Abdominal Spatula
IM-04-735-03
13"
50 mm

Retractor



Abdominal Spatula
Haberer
IM-04-740-00
8"
17 – 25 mm

Abdominal Spatula
Haberer
IM-04-740-01
11"
25 – 30 mm

Abdominal Spatula
Haberer
IM-04-740-02
11 3/4"
37 – 45 mm

Retractor



Abdominal Spatula
Martin
IM-04-745-06
8"
6,5 mm wide

Abdominal Spatula
Martin
IM-04-745-09
8"
9,5 mm wide

Abdominal Spatula
Martin
IM-04-745-13
8"
13 mm wide

Abdominal Spatula
Martin
IM-04-745-16
8"
16 mm wide

Abdominal Spatula
Martin
IM-04-745-19
8"
19 mm wide

Abdominal Spatula
Martin
IM-04-745-25
8"
25 mm wide

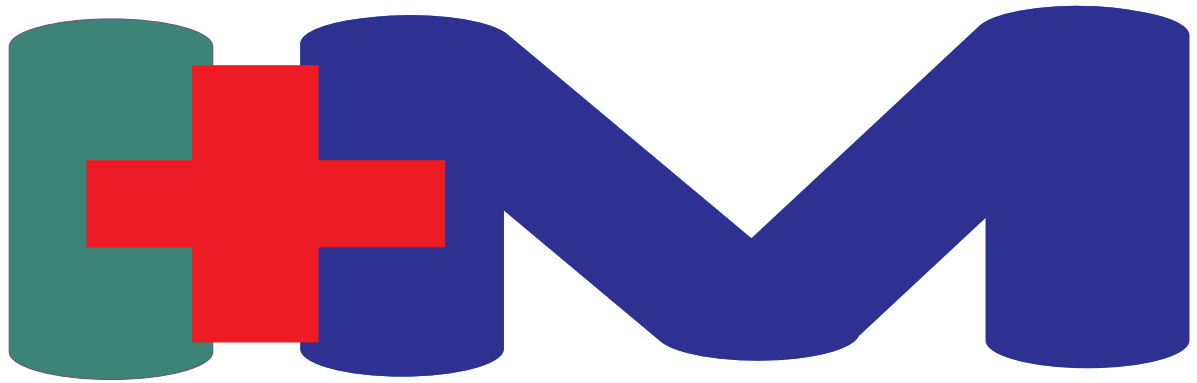

IBRAHIM MEDS

I N S T R U M E N T S

 77 A Model Town Ugoki Sialkot

 +92 52 3512235

 +92 52 4007564

 +92 300 7163508 , +92 307 6427547

 info@ibrahimmeds.com

 amjad@ibrahimmeds.com

 www.ibrahimmeds.com