

WE SERVE HUMANITY WITH EXCELLENCE

IBRAHIM MEDS

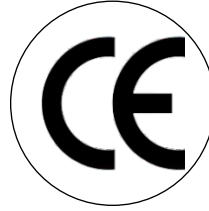

Neuro Surgery Micro Instrument



1/2



	25°	45°	60°	90°	125°
	10 mm	10 mm	10 mm	10 mm	10 mm
18 cm / 7 1/8"	IM-400-25-07	IM-400-45-07	IM-400-60-07	IM-400-90-07	IM-401-00-07
18 cm / 7 1/8"	IM-408-25-09	IM-408-45-09	IM-408-60-09	IM-408-90-09	IM-409-00-09

IM-400-25-07 - IM-409-00-09



1/2



	25°	45°	60°	90°	125°
	7 mm	7 mm	7 mm	7 mm	7 mm
18 cm / 7 1/8"	IM-402-25-07	IM-402-45-07	IM-402-60-07	IM-402-90-07	11-403-00-07
18 cm / 7 1/8"	IM-410-25-09	IM-410-45-09	IM-410-60-09	IM-410-90-09	11-411-00-09

IM-402-25-07 - IM-411-00-09



1/2

IM-710-15-07 - IM-717-18-09

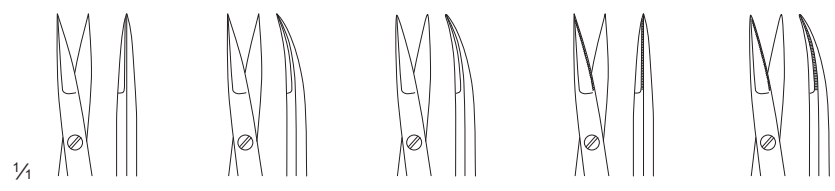

	A	A	D	A-SB	D-SB
	10 mm	10 mm	10 mm	10 mm	10 mm
15 cm / 7 1/8"	IM-710-15-07	IM-711-15-07			
15 cm / 7 1/8"	IM-716-15-09	IM-717-15-09			
18 cm / 7 1/8"	IM-710-18-07	IM-711-18-07	IM-711-19-07	IM-710-19-07	IM-711-20-07
18 cm / 7 1/8"	IM-716-18-09	IM-717-18-09			



1/2

IM-712-15-07 - IM-719-18-09



	A	A	D	A-SB	D-SB
	10 mm	10 mm	10 mm	10 mm	10 mm
15 cm / 7 1/8"	IM-712-15-07	IM-713-15-07			
15 cm / 7 1/8"	IM-718-15-09	IM-719-15-09			
18 cm / 7 1/8"	IM-712-18-07	IM-713-18-07	IM-713-19-07	IM-712-19-07	IM-713-20-07
18 cm / 7 1/8"	IM-718-18-09	IM-719-18-09			

A = Adventitia
 D = Dissection
 A-SB = Adventitia, one serrated blade
 D-SB = Dissection, one serrated blade



Biemer
IM-758-12-07
12 cm / 4⁵/₈"

Micro scissors for veins



Vannas
IM-850-01-07 - IM-850-03-07
12 cm / 4⁵/₈"

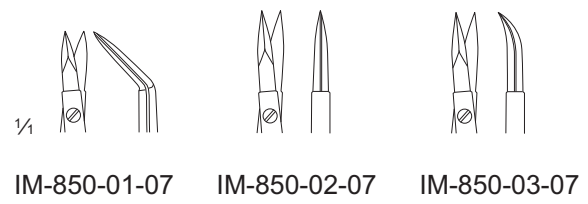

Vannas
IM-850-04-07 - IM-850-05-07
16 cm / 6²/₈"

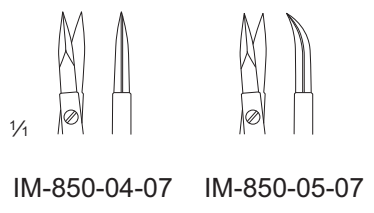

Millesi
IM-850-10-07 - IM-850-11-07
16 cm / 6²/₈"



Jacobson
IM-850-15-07
18,5 cm / 7²/₈"

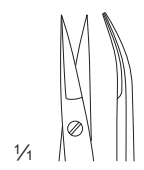



1/2

Yasargil
IM-850-20-07 - IM-850-24-07

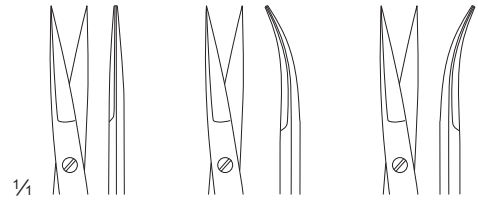

16 cm / 6 ² / ₈ "	St	IM-850-20-07	IM-850-21-07	
20 cm / 7 ⁷ / ₈ "	St	IM-850-22-07	IM-850-23-07	IM-850-24-07



1/2

Yasargil
IM-850-25-07 - IM-850-33-07

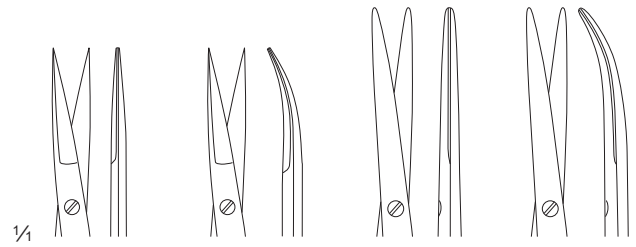

	A	A	D	D
	15 mm	15 mm	15 mm	15 mm
20 cm / 7 ⁷ / ₈ "	St		IM-850-30-07	IM-850-31-07
22,5 cm / 8 ⁷ / ₈ "	St	IM-850-25-07	IM-850-26-07	IM-850-32-07
24,5 cm / 9 ⁷ / ₈ "	St		IM-850-28-07	



Nagel
IM-850-40-07
20 cm / 7⁷/₈"



8"
Nagel
IM-850-41-07
20 cm / 7⁷/₈"



Nagel
IM-850-42-07
20 cm / 7⁷/₈"

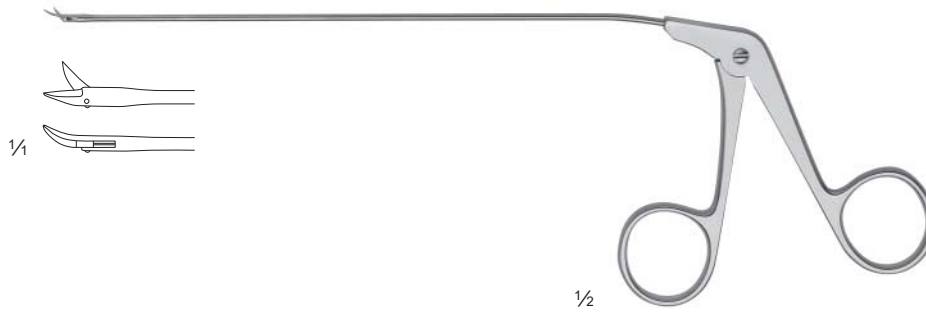

Fahlbusch
IM-850-50-07
16,5 cm / 6 1/8"

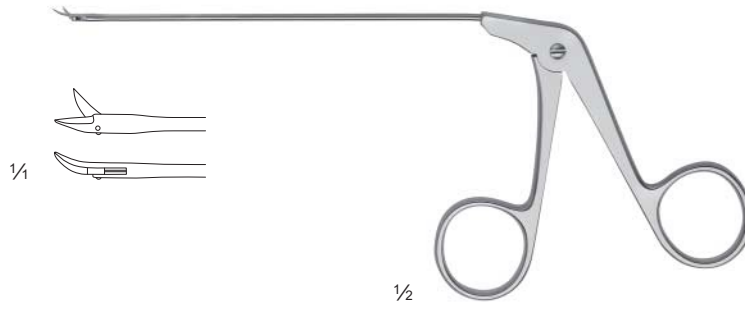

Caspar
IM-850-60-07
11,5 cm / 4 1/8"



1/2

IM-562-00-07 - IM-563-05-07

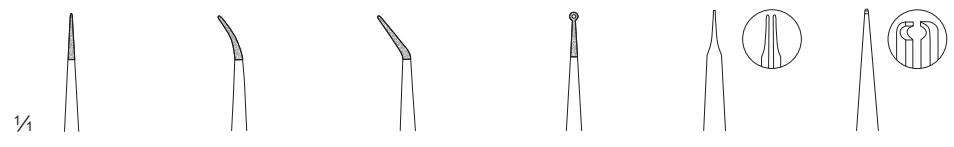

			45°			Pierce
	Ø 0.30 mm	0.30 mm	0.30 mm	R Ø 1.0 x 0.5 mm	VD 0.30 mm	P 0.30 mm
15 cm / 5 7/8"	St IM-562-00-07	IM-562-01-0	IM-562-02-07	IM-562-03-07	IM-562-04-07	IM-562-05-07
18 cm / 7 1/8"	St IM-563-00-07	IM-563-01-07	IM-563-02-07	IM-563-03-07	IM-563-04-07	IM-563-05-07



1/2

IM-564-15-07 - IM-581-21-09



	Ø 0.40 mm	0.40 mm	0.70 mm	0.70 mm	0.80 mm	0.80 mm
15 cm / 5 7/8"	St IM-564-15-07	IM-565-15-07	IM-566-15-07	IM-567-15-07		
15 cm / 5 7/8"	Ti IM-578-15-09	IM-579-15-09			IM-580-15-09	IM-581-15-09
18 cm / 7 1/8"	St IM-564-18-07	IM-565-18-07	IM-566-18-07	IM-567-18-07		
18 cm / 7 1/8"	Ti IM-578-18-09	IM-579-18-09			IM-580-18-09	IM-581-18-09
21 cm / 8 2/8"	St		IM-566-21-07	IM-567-21-07		
21 cm / 8 2/8"	Ti				IM-580-21-09	IM-581-21-09
23 cm / 9"	St		IM-566-23-07	IM-567-23-07		

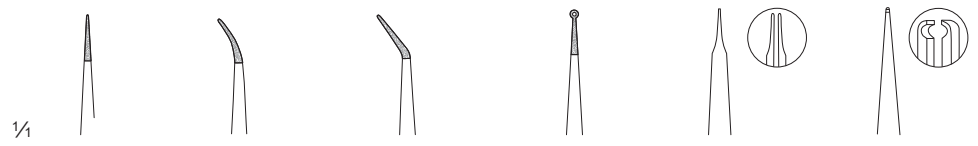

			45°			Pierse
	∅ 0.30 mm	0.30 mm	0.30 mm	R Ø 1.0 x 0.5 mm	VD* 0.30 mm	P 0.40 mm
15 cm / 5 7/8"	st IM-591-00-07	IM-591-01-07	IM-591-02-07	IM-591-03-07	IM-591-04-07	IM-591-05-07
18 cm / 7 1/8"	st IM-592-00-07	IM-592-01-07	IM-592-02-07	IM-592-03-07	IM-592-04-07	IM-592-05-07

*VD = Vascular dilator

1/2

12-591-01-07 - 12-592-05-07

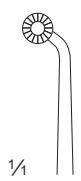

IM-852-60-07
5 mm
abgewinkelt
angled
acodado
coudé
angolato

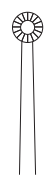

IM-852-61-07
5 mm
bajonett
bayonet
bayoneta
baïonnette
baionetta

1/2

Hunt
IM-852-60-07 - IM-852-61-07
20 cm / 7 7/8"

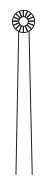

IM-852-30-07
3 mm

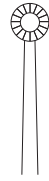

IM-852-31-07
5 mm

1/2

Heifetz
IM-852-30-07 - IM-852-31-07
22 cm / 8 5/8"



1/2



	mm	1:2	1:2	1:2	1:2	1:2	
	Ø	0.40 mm	0.40 mm	0.70 mm	0.70 mm	0.80 mm	0.80 m
15 cm / 5 7/8"	St	IM-568-15-07	IM-569-15-07	IM-570-15-07	IM-571-15-07		
15 cm / 5 7/8"	Ti	IM-582-15-09	IM-583-15-09			IM-584-15-09	IM-585-15-09
18 cm / 7 1/8"	St	IM-568-18-07	IM-569-18-07	IM-570-18-07	IM-571-18-07		
18 cm / 7 1/8"	Ti	IM-582-18-09	IM-583-18-09			IM-584-18-09	IM-585-18-09
21 cm / 8 2/8"	St			IM-570-21-07	IM-571-21-07		
21 cm / 8 2/8"	Ti					IM-584-21-09	IM-585-21-09
23 cm / 9"	St			IM-570-23-07	IM-571-23-07		

12-568-15-07 - 12-585-21-09



1/2

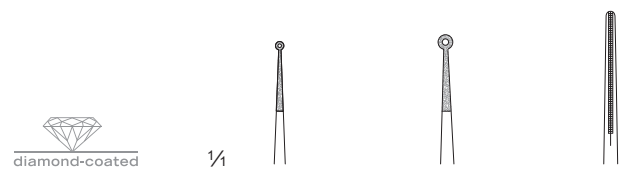

			Atrauma
	Ø	R Ø 1.0 x 0.5 mm	R Ø 2.0 x 1.0 mm 1.2 mm
15 cm / 5 7/8"	St	IM-574-15-07	IM-576-15-07 IM-589-15-07
15 cm / 5 7/8"	Ti	IM-586-15-09	IM-588-15-09 IM-590-15-09
18 cm / 7 1/8"	St	IM-574-18-07	IM-576-18-07 IM-589-18-07
18 cm / 7 1/8"	Ti	IM-586-18-09	IM-588-18-09 IM-590-18-09
21 cm / 8 2/8"	St	IM-574-21-07	IM-576-21-07 IM-589-21-07
21 cm / 8 2/8"	Ti	IM-586-21-09	IM-588-21-09 IM-590-21-09
23 cm / 9"	St	IM-574-23-07	IM-576-23-07

IM-574-15-07 - IM-590-21-09

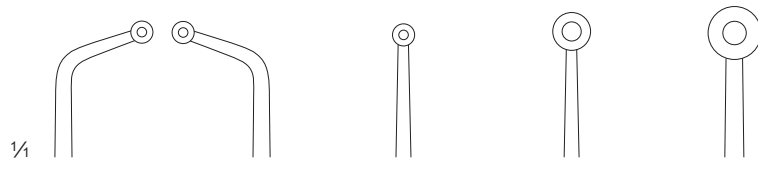

	Samii	Samii	Yasargil-Samii	Yasargil-Samii	Yasargil-Samii
	∅ 3.0 mm	3.0 mm	3.0 mm	5.0 mm	7.0 mm
23 cm / 9"	St IM-852-01-07	IM-852-02-07			
24 cm / 9 ⁴ / ₈ "	St		IM-852-10-07	IM-852-11-07	IM-852-12-07

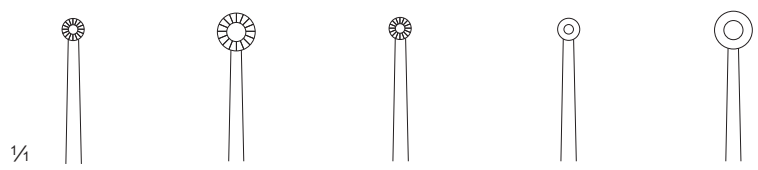

	Yasargil	Yasargil	Yasargil	Yasargil	Yasargil
	∅ 3.0 mm	5.0 mm	3.0 mm	3.0 mm	5.0 mm
16,5 cm / 6 ⁴ / ₈ "	St IM-852-20-07	IM-852-21-07			
20 cm / 7 ⁷ / ₈ "	St		IM-852-22-07		
22 cm / 8 ⁵ / ₈ "	St			IM-852-23-07	IM-852-24-07

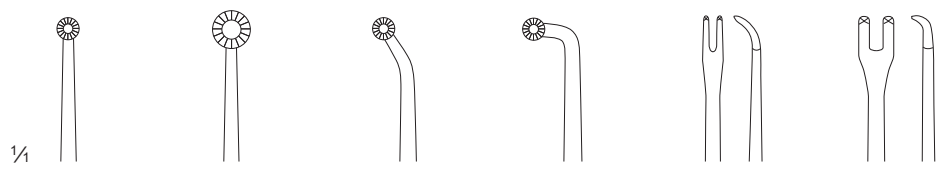

	Yasargil	Yasargil	Yasargil	Yasargil	Yasargil	Yasargil
			45°	90°		
	∅ 3.0 mm	5.0 mm	3.0 mm	3.0 mm	3.0 mm	5.0 mm
22 cm / 8 ⁵ / ₈ "	St IM-852-25-07	IM-852-26 -07	IM-852-40-07	IM-852-41-07	IM-852-50-07	IM-852-51-07

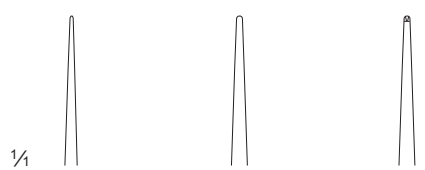

	Yasargil	Yasargil	Yasargil
	∅ 0.6 mm	0.9 mm	
	mm		1:2
18 cm / 7 ¹ / ₈ "	St IM-852-70-07	IM-852-71-07	IM-852-72-07
20 cm / 7 ⁷ / ₈ "	St IM-852-73-07	IM-852-74-07	
22 cm / 8 ⁵ / ₈ "	St IM-852-75-07	IM-852-76-07	
24 cm / 9 ⁴ / ₈ "	St IM-852-77-07	IM-852-78-07	





15 cm / 5 7/8"	Ø	0.30 mm	0.30 mm	0.30 mm	0.30 mm
	St	IM-000-01-07	IM-001-01-07	IM-000-00-07	IM-001-00-07

1/2

IM-000-00-07 - IM-001-01-07



15 cm / 5 7/8"	Ø	0.30 mm	0.30 mm	0.30 mm	0.30 mm
	St	IM-000-03-07	IM-001-03-07	IM-000-02-07	IM-001-02-07

1/2

Castroviejo
IM-000-02-07 -
IM-001-02-07



1/2



	Ø 0.40 mm	0.40 mm	0.40 mm	0.40 mm
15 cm / 5 7/8"	St IM-002-15-07	IM-003-15-07	IM-004-15-07	IM-005-15-07
15 cm / 5 7/8"	Ti IM-016-15-09	IM-017-15-09	IM-018-15-09	IM-019-15-09
18 cm / 7 1/8"	St IM-002-18-07	IM-003-18-07	IM-004-18-07	IM-005-18-07
18 cm / 7 1/8"	Ti IM-016-18-09	IM-017-18-09	IM-018-18-09	IM-019-18-09

IM-002-15-07 -
IM-019-18-09



1/2



	Ø 0.40 mm	0.40 mm	0.40 mm	0.40 mm
18 cm / 7 1/8"	St IM-006-18-07	IM-007-18-07	IM-008-18-07	IM-009-18-07

Castroviejo
IM-006-18-07 -
IM-009-18-07

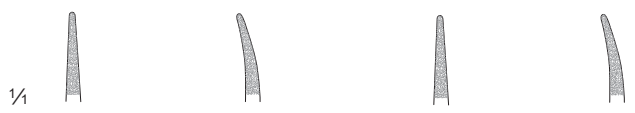

	mit Sperre with ratchet con trinquete avec cran d'arrêt con arresto	mit Sperre with ratchet con trinquete avec cran d'arrêt con arresto	ohne Sperre w/o ratchet sin trinquete sans cran d'arrêt senza arresto	ohne Sperre w/o ratchet sin trinquete sans cran d'arrêt senza arresto
	Ø 0.80 mm	0.80 mm	0.80 mm	0.80 mm
15 cm / 5 7/8"	St IM-010-15-07	IM-011-15-07	IM-012-15-07	IM-013-15-07
15 cm / 5 7/8"	Ti IM-020-15-09	IM-021-15-09	IM-022-15-09	IM-023-15-09
18 cm / 7 1/8"	St IM-010-18-07	IM-011-18-07	IM-012-18-07	IM-013-18-07
18 cm / 7 1/8"	Ti IM-020-18-09	IM-021-18-09	IM-022-18-09	IM-023-18-09
21 cm / 8 2/8"	St IM-010-21-07	IM-011-21-07	IM-012-21-07	IM-013-21-07
21 cm / 8 2/8"	Ti IM-020-21-09	IM-021-21-09	IM-022-21-09	IM-023-21-09
23 cm / 9"	St IM-010-23-07	IM-011-23-07	IM-012-23-07	IM-013-23-07

1/2

IM-010-15-07 -
IM-013-23-07

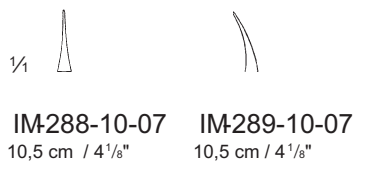

1/2

Barraquer-Troutman
IM-288-10-07 - IM-289-10-07

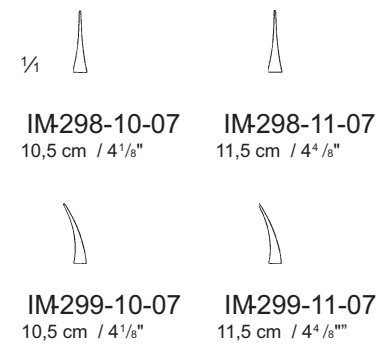

1/2

Barraquer-Troutman
IM-298-10-07 - IM-299-11-07

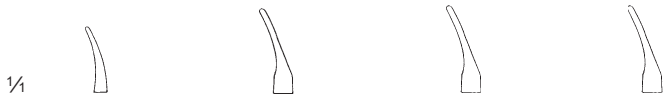

11,5 cm / 4 1/8"	St	IM-300-11-07			
11,5 cm / 4 1/8"	Ti	IM-300-12-09			
13,5 cm / 5 3/8"	St		IM-300-13-07		
14 cm / 5 1/2"	St			IM-300-14-07	
14 cm / 5 1/2"	Ti				IM-300-15-09

1/2

Barraquer
IM-300-11-07 -
IM-300-15-07



1/2

Barraquer
IM-301-13-07
13,5 cm / 5 3/8"



1/2

Castroviejo-Fine
IM-302-01-07
13 cm / 5 1/8"



1/2

Castroviejo-Fine
IM-304-01-07
13 cm / 5 1/8"

sehr feines Maul, mit Sperre
very delicate jaw, with lock
boca muy delicada, con cierre
mors très fin, avec serrure
morso strafino, con fermo



1/2

Castroviejo-Fine
IM-305-01-07
13 cm / 5 1/8"

sehr feines Maul, mit Sperre
very delicate jaw, with lock
boca muy delicada, con cierre
mors très fin, avec serrure
morso strafino, con fermo

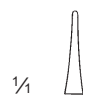

IM-306-14-07
14,5 cm / 5⁹/₈"



IM-307-14-07
14,5 cm / 5⁹/₈"

1/2

Castroviejo
IM-306-14-07 - IM-307-14-07

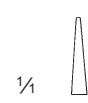

IM-308-14-07
14,5 cm / 5⁹/₈"



IM-309-14-07
14,5 cm / 5⁹/₈"

1/2

Castroviejo
IM-308-14-07 - IM-309-14-07

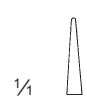

IM-310-14-07
14,5 cm / 5⁹/₈"



IM-311-14-07
14,5 cm / 5⁹/₈"

1/2

Castroviejo
IM-310-14-07 - IM-311-14-07



1/2

Castroviejo
IM-313-14-07
14,5 cm / 5⁹/₈"

TC GOLD



1/2

Castroviejo
IM-620-00-07 -
IM-621-21-07

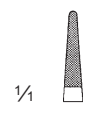

1/4

IM-620-00-07
14,5 cm / 5 5/8"



IM-620-01-07
14,5 cm / 5 5/8"



IM-620-14-07
14,5 cm / 5 5/8"

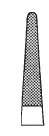

IM-620-18-07
18 cm / 7 1/8"

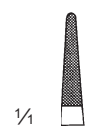

1/4

IM-620-21-07
22 cm / 8 5/8"



IM-621-14-07
14,5 cm / 5 5/8"



IM-621-18-07
18 cm / 7 1/8"



IM-621-21-07
22 cm / 8 5/8"



1/2

Barraquer
IM-626-13-07
13 cm / 5 1/8"

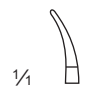

1/4



1/2

Barraquer
IM-628-13-07
13 cm / 5 1/8"

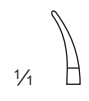

1/4



IM-851-01-07
18 cm / 7 1/8"
ohne Sperre
w/o ratchet
sin trinquete
sans cran d'arrêt
senza arresto



Jacobson
IM-851-02-07
18 cm / 7 1/8"
mit Sperre
with ratchet
con trinquete
avec cran d'arrêt
con arresto



1/2

Yasargil
IM-851-10-07 - IM-851-13-07

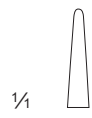

IM-851-10-07
20 cm / 7⁷/₈"



IM-851-11-07
20 cm / 7⁷/₈"



IM-851-12-07
22,5 cm / 8⁷/₈"



IM-851-13-07
22,5 cm / 8⁷/₈"

1/4

	Fig. 1	Fig. 2	Fig. 3	Fig. 4
St	IM-857-01-07	IM-857-02-07	IM-857-03-07	IM-857-04-07
Ti	IM-857-01-09	IM-857-02-09	IM-857-03-09	IM-857-04-09

1/4

	Fig. 5	Fig. 6	Fig. 7	Fig. 8
St	IM-857-05-07	IM-857-06-07	IM-857-07-07	IM-857-08-07
Ti	IM-857-05-09	IM-857-06-09	IM-857-07-09	IM-857-08-09

1/4

	Fig. 9	Fig. 10	Fig. 11	Fig. 12
St	IM-857-09-07	IM-857-10-07	IM-857-11-07	IM-857-12-07
Ti	IM-857-09-09	IM-857-10-09	IM-857-11-09	IM-857-12-09

1/4

	Fig. 13	Fig. 14	Fig. 15	Fig. 16
St	IM-857-13-07	IM-857-14-07	IM-857-15-07	IM-857-16-07
Ti	IM-857-13-09	IM-857-14-09	IM-857-15-09	IM-857-16-09

1/4

	Fig. 17	Fig. 18	Fig. 19
St	IM-857-17-07	IM-857-18-07	IM-857-19-07
Ti	IM-857-17-09	IM-857-18-09	IM-857-19-09



Rhoton
 IM-857-01-07 -
 IM-857-19-09
 19 cm / 7 4/8"



Rhoton
IM-857-00-07

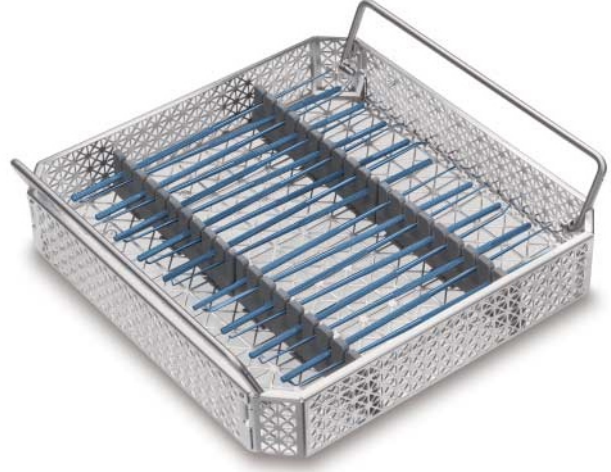

Rhoton
IM-857-00-09



IM-803-50-04



Yasargil
 IM-853-01-07 - IM-853-02-07
 20 cm / 7⁷/₈"

1/2

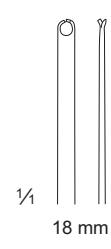

IM-853-03-07
 18,5 cm / 7²/₈"

1/2

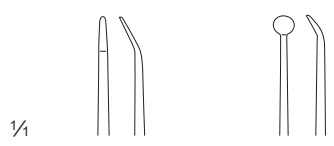

Ø	Samii	Samii
1,0 mm	St IM-854-01-07	
1,5 mm	St IM-854-02-07	IM-854-09-07
2,0 mm	St IM-854-03-07	
2,5 mm	St IM-854-04-07	
3,0 mm	St IM-854-05-07	IM-854-10-07
3,5 mm	St IM-854-06-07	
4,0 mm	St IM-854-07-07	
4,5 mm	St	IM-854-11-07
5,0 mm	St IM-854-08-07	
6,0 mm	St	IM-854-12-07

Samii
 IM-854-01-07 - IM-854-12-07
 23 cm / 9"

1/2



Caspar
IM-856-01-07 -
IM-856-10-07

1/2

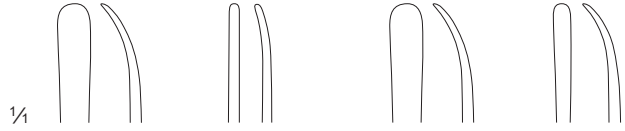

	∅ 4,5 mm	1,0 mm	4,5 mm	2,0 mm
23 cm / 9"	st IM-856-01-07	IM-856-04-07	IM-856-02-07	IM-856-03-07

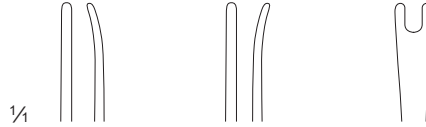

	∅ 1,0 mm	1,0 mm		
20 cm / 7 7/8"	st IM-856-05-07	IM-856-06-07		
23 cm / 9"	st			

IM-856-10-07



Samii
IM-858-01-07
23 cm / 9"

IM-858-10-07 -
IM-858-30-07

1/2

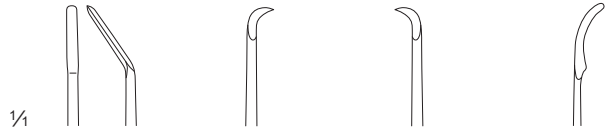

	Samii	Koos	Koos	Koos
	∅ 1,8 mm			
18,5 cm / 7 2/8"	st	IM-858-10-07	IM-858-11-07	IM-858-12-07
23 cm / 9"	st IM-858-01-07			

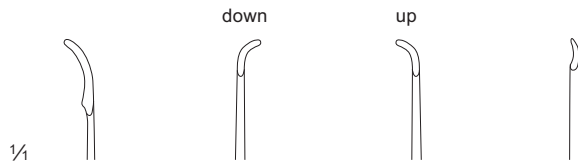

	Koos	Yasargil	Yasargil	Jacobson
18,5 cm / 7 2/8"	st IM-858-13-07	IM-858-20-07	IM-858-21-07	IM-858-30-07



Yasargil
IM-860-01-07 -
IM-860-04-07
18,5 cm / 7²/₈"

1/2

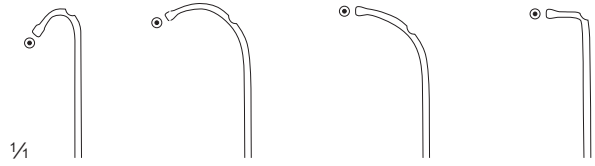

18,5 cm / 7²/₈"  IM-860-01-07 IM-860-02-07 IM-860-03-07 IM-860-04-07

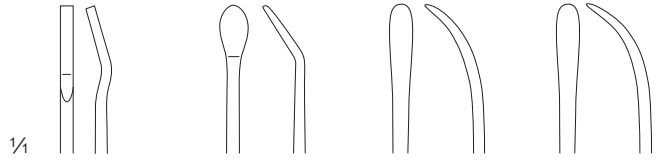

18,5 cm / 7²/₈"  IM-862-01-07 IM-862-02-07 IM-862-03-07 IM-862-04-07



Yasargil
IM-862-01-07 -
IM-862-20-07

1/2

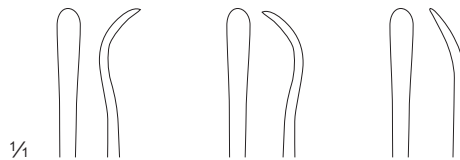

18,5 cm / 7²/₈"  IM-862-05-07 IM-862-06-07 IM-862-07-07

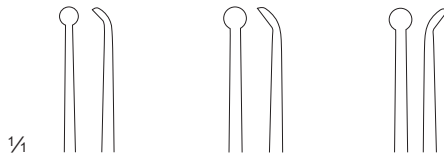

23 cm / 9"  IM-862-10-07 IM-862-11-07 IM-862-20-07

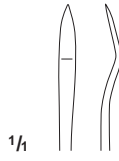

	2,6 mm
18,5 cm / 7 ² / ₈ "	IM-863-01-07

8"

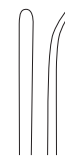
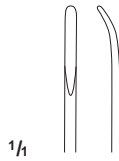

	2,2 mm	2,2 mm	2,2 mm	2,0 mm
	IM-863-10-07	IM-863-12-07	IM-863-11-07	IM-863-13-07

Yasargil
IM-863-01-07 -
IM-863-13-07

23 cm / 9"

1/2

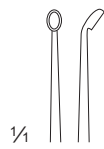
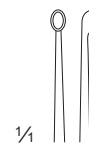

1/2

Jacobson
IM-864-01-07
18,5 cm / 7²/₈"



1/2

Jacobson
IM-864-02-07
18,5 cm / 7²/₈"



1/2

Yasargil
IM-865-01-07
18,5 cm / 7²/₈"



1/4

1/2

IM-865-10-07
23 cm / 9"



1/4

1/2

IM-865-11-07
23 cm / 9"

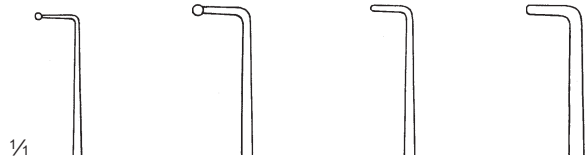
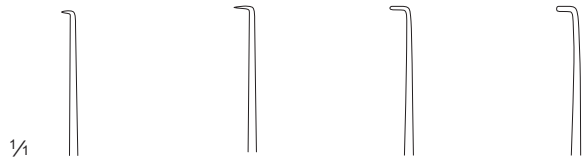
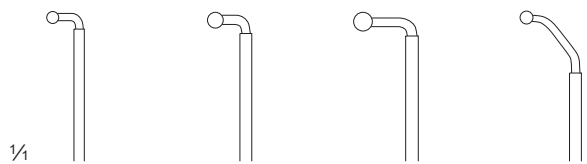

	Fig. 1	Fig. 2	Fig. 3	Fig. 4
19 cm / 7 ⁵ / ₈ "	st IM-940-01-07	IM-940-02-07	IM-940-03-07	IM-940-04-07



	90° 1 mm	90° 2 mm	90°	90°
19 cm / 7 ⁵ / ₈ "	st IM-830-19-07	IM-831-19-07		
23 cm / 9"	st		IM-866-01-07	IM-866-02-07



	Caspar 90°	Caspar 90°	Caspar 90°	Caspar 45°
	st 5 mm	7 mm	9 mm	11 mm
24,5 cm / 9 ⁵ / ₈ "	st IM-942-05-07	IM-942-07-07	IM-942-09-07	IM-942-11-07

IM-830-19-07 -
IM-942-11-07

1/2

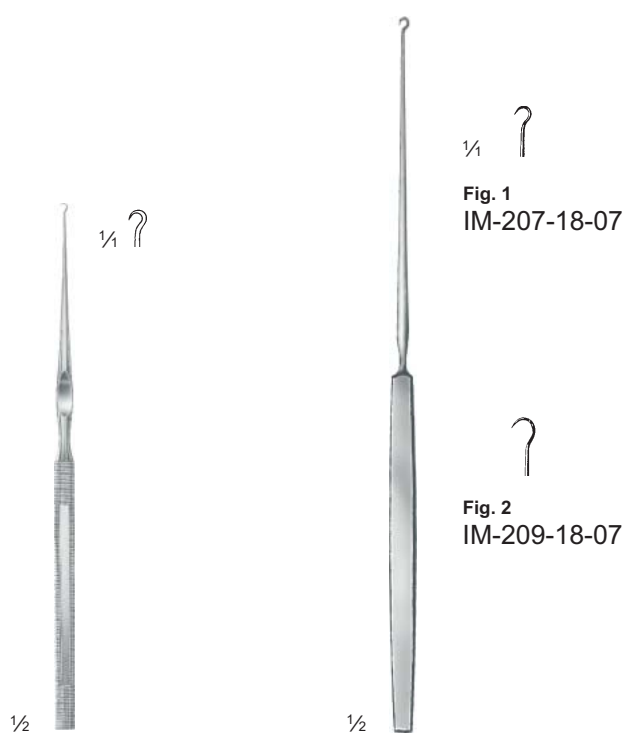

Kilner
IM-203-15-07
14,5 cm / 5⁹/₁₆"

Gillies
IM-207-18-07 - 28-209-18-07
18 cm / 7¹/₈"

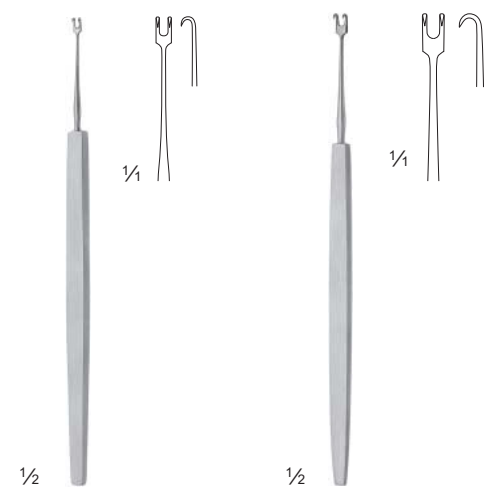

Guthrie
IM-700-12-07
12 cm / 4⁹/₁₆"

Guthrie
IM-702-13-07
13 cm / 5¹/₈"

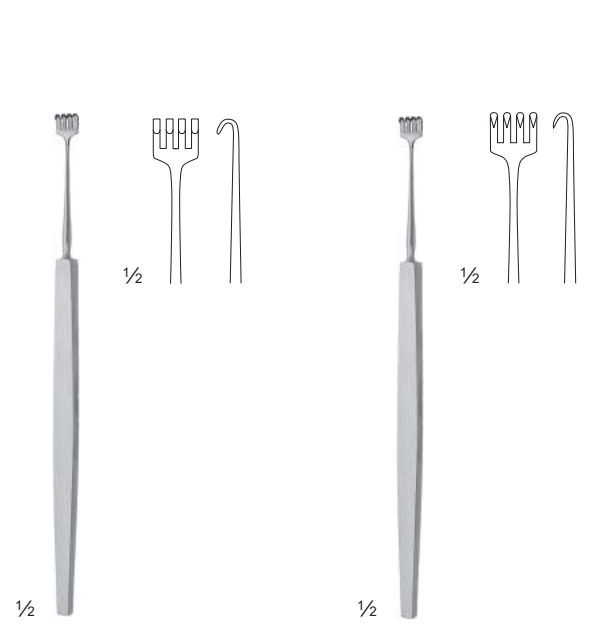

Knapp
IM-711-13-07
13 cm / 5¹/₈"

Rollet
IM-716-13-07
13 cm / 5¹/₈"

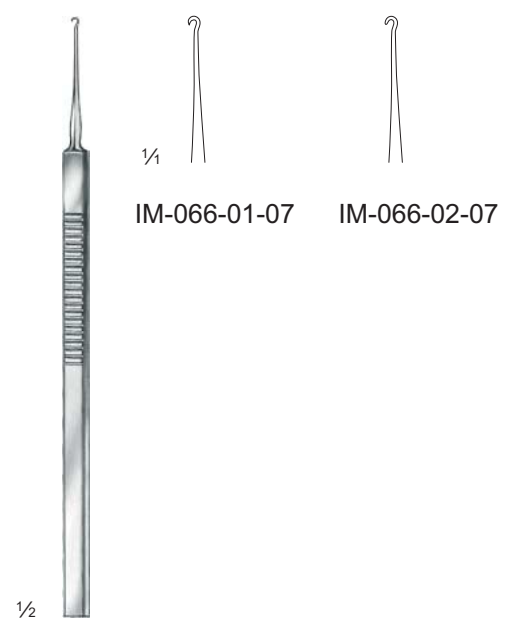

Graefe
IM-066-01-07 - IM-066-02-07
15 cm / 5⁷/₈"



Joseph
IM-684-15-07
15,5 cm / 6 1/8"

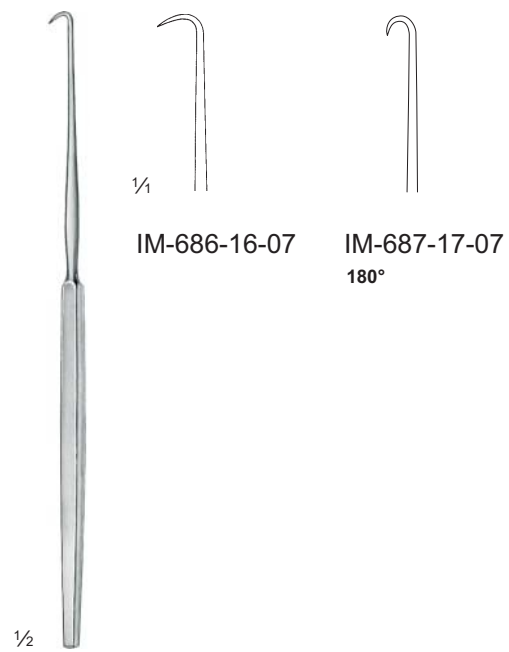

Cottle
IM-686-16-07 - 37-687-17-07
17 cm / 6 1/8"



Freer
IM-702-15-07
15 cm / 5 7/8"

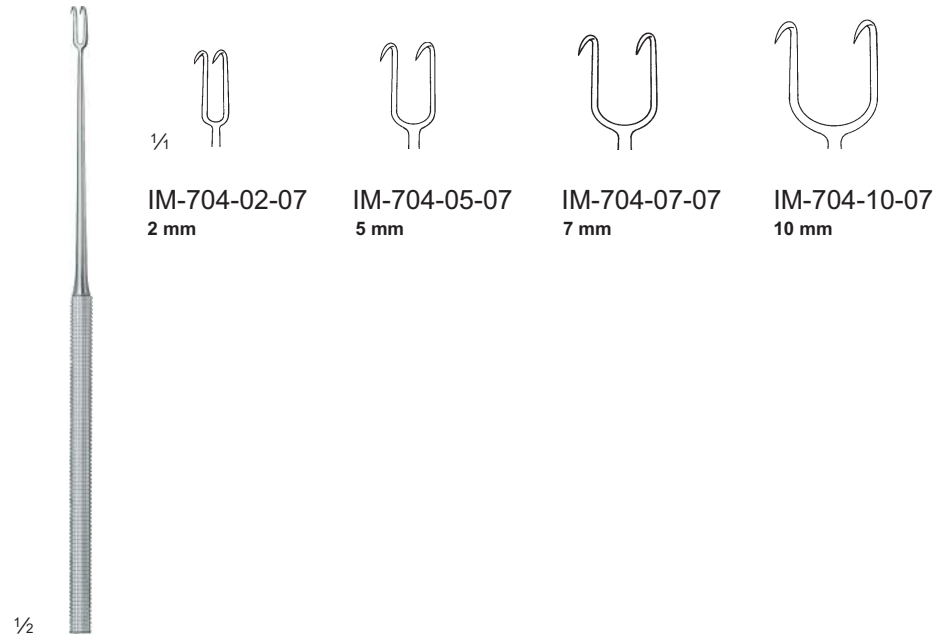

Joseph
IM-704-02-07 - IM-704-10-07
16 cm / 6 1/8"

Additional microsurgical instrument set

consisting of:

Art.-Nr. Art. No.	Menge Unit	Description
IM-160-01-07	1	Scalpel handle for micro blade, 13.5 cm
IM-843-14-07	1	Curette acc. Mikaeel fig. 14, 45°, bayonet
IM-842-00-04	1	Handle for Mikaeel instruments
IM-853-03-07	1	Tissue forceps with protector, 18 mm, 18.5 cm
IM-863-10-07	1	Micro dissector, straight, slim, 23 cm
IM-863-12-07	1	Micro dissector, straight, 23 cm
IM-858-30-07	1	Micro vascular knife, Jacobson, straight, 18.5 cm
IM-866-01-07	1	Micro hooklet, sharp, 23 cm
IM-866-02-07	1	Micro hooklet, blunt, 23 cm
IM-940-02-07	1	Nerve hook, Krayenbuehl, No. 2, 19 cm
IM-940-03-07	1	Nerve hook, Krayenbuehl, No. 1, 19 cm
IM-831-19-07	1	Dura hooklet, 90°, sharp, angled down, 19 cm
IM-852-61-07	1	Grasping forceps, Hunt, bayonet, 5 mm, 20 cm
IM-852-22-07	1	Grasping forceps, Yasargil, bayonet, 3 mm, 20 cm
IM-852-74-07	1	Micro forceps, Yasargil, bayonet, 0.9 mm, 20 cm
IM-852-70-07	1	Micro forceps, Yasargil, bayonet, 0.6 mm, 18 cm
IM-852-72-07	1	Micro forceps, Yasargil, bayonet, 1 x 2 teeth, 18 cm
IM-852-78-07	1	Micro forceps, Yasargil, bayonet, 0.9 mm, 24 cm
IM-850-25-07	1	Micro scissors, Yasargil, bayonet, straight, 22.5 cm
IM-850-21-07	1	Micro scissors, Yasargil, bayonet, curved, 16.5 cm
IM-850-22-07	1	Micro scissors, Yasargil, bayonet, straight, 20 cm
IM-620-21-07	1	TC micro needle holder, straight, with lock, 22 cm
IM-711-19-07	1	Micro scissors, blunt/blunt, curved, 10 mm, 18 cm
IM-844-83-07	1	Micro Alligator forceps acc. Tew

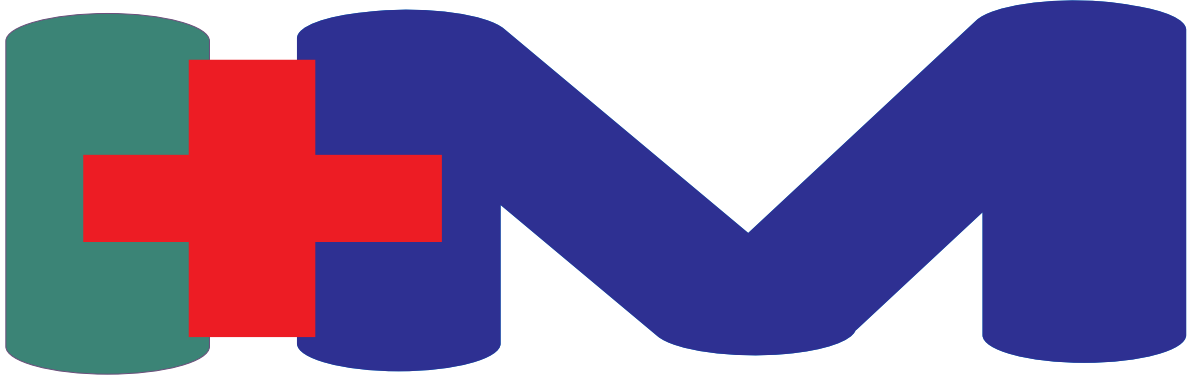

IBRAHIM MEDS

I N S T R U M E N T S

 77 A Model Town Ugoki Sialkot

 +92 52 3571235

 +92 52 4007564

 +92 300 7163508 , +92 307 6427547

 info@ibrahimmeds.com

 amjad@ibrahimmeds.com

 www.ibrahimmeds.com